

REPLACEMENT PARTS

ITEM	PT/ASSY	SPECIFY FINISH	DESCRIPTION
1	91762		O-RING, #2-132, EP, 50 DURO - GREY
2	1-393		1-1/8 18 UNEF MOUNTING KIT
3	125-8		SOAP DISPENSER PUMP ASM
4	125-9		SOAP DISPENSER BOTTLE
5	20-373	YES	SOAP PUMP HEAD ASM CONTEMP

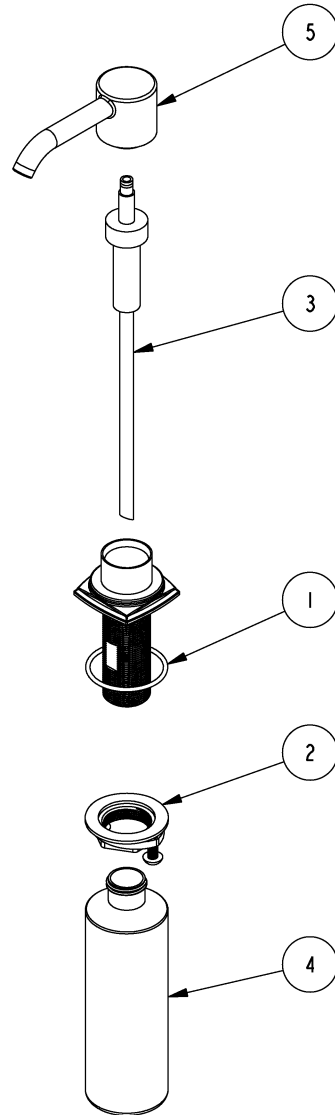

SOAP / LOTION DISPENSER
3160-5721

REV D EN-4648 02/02/24

NEWPORT BRASS.

t: 949.417.5207 | www.newportbrass.com