

REPLACEMENT PARTS

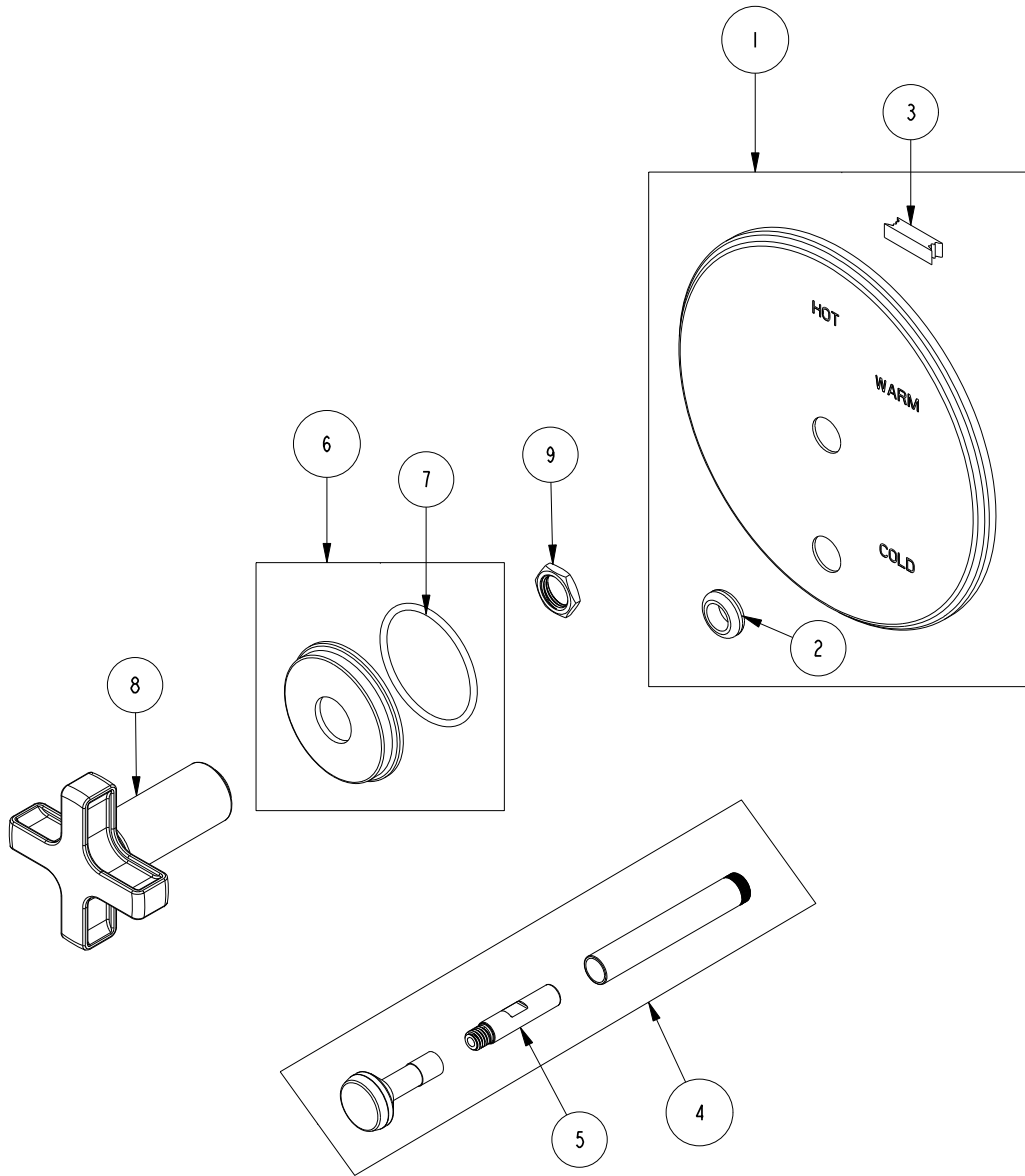

ITEM	PT/ASSY	SPECIFY FINISH	DESCRIPTION
1	2-438	YES	COVERPLATE BP W/DIV ASM
2	91033		GROMMET
3	H-78		TAPE NEO
4	2-217	YES	DIVERTER TRIM KIT
5	91065		UPPER LINK PLASTIC DIVERTER
6	20-433	YES	ESCUTCHEON ASM
7	91773		O-RING, #2-133, 50 DURO
8	20-430	YES	CROSS HANDLE ASM
9	10259		HEX NUT 9/16 X 20 MADE

BP TUB & SHOWER TRIM
5-3282BP

REV C EN-4847 07/24/24

NEWPORT BRASS.

t: 949.417.5207 | www.newportbrass.com