

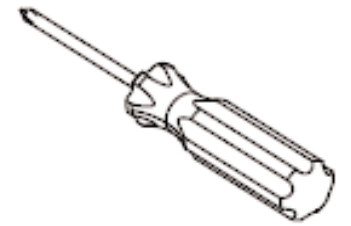





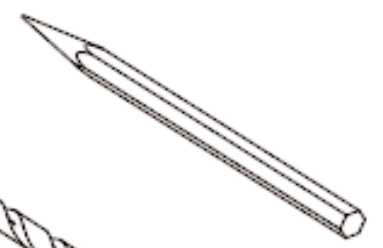

ITEMS INCLUDED		TOOLS REQUIRED	
DRY WALL ANCHOR	 X 2	PHILLIPS SCREW DRIVER	
TILE ANCHOR	 X 2	PEN / PENCIL	
#8 SCREW	 X 2	1/4"(6 mm) DRILL	
MOUNTING BRACKET	 X 1	LEVEL SET	
M6 X 6 SET SCREW	 X 1	HAMMER	
3 MM HEX KEY	 X 1		
HANGING TT HOLDER	 X 1		

INSTALLATION INSTRUCTIONS

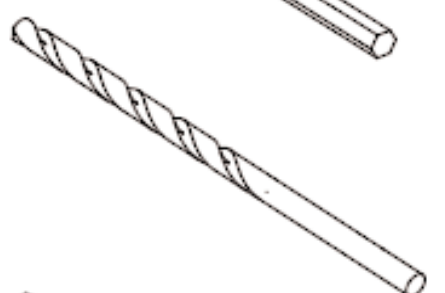
3250-1510

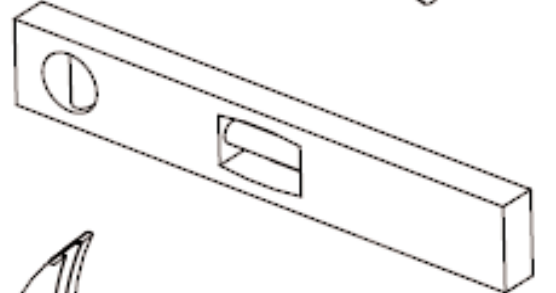
HANGING TT HOLDER

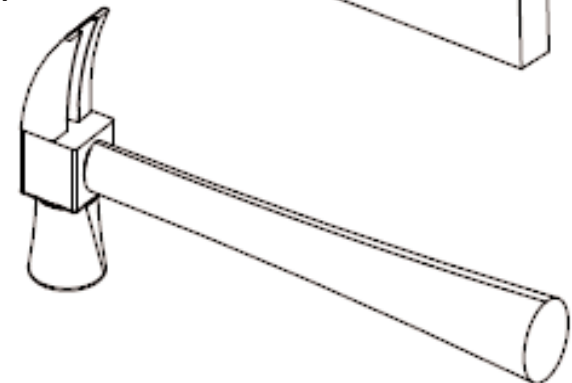
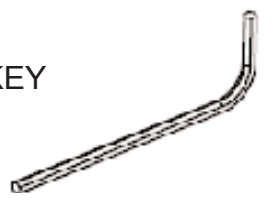
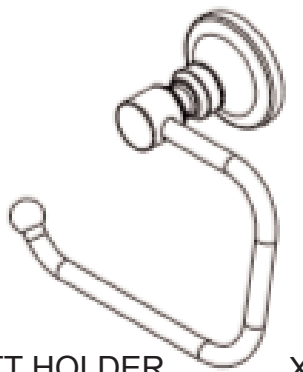

2001 CARNEGIE AVE, SANTA ANA CA 92705
 (949) 417-5207
 WWW.NEWPORTBRASS.COM

① REMOVE MOUNTING BRACKET

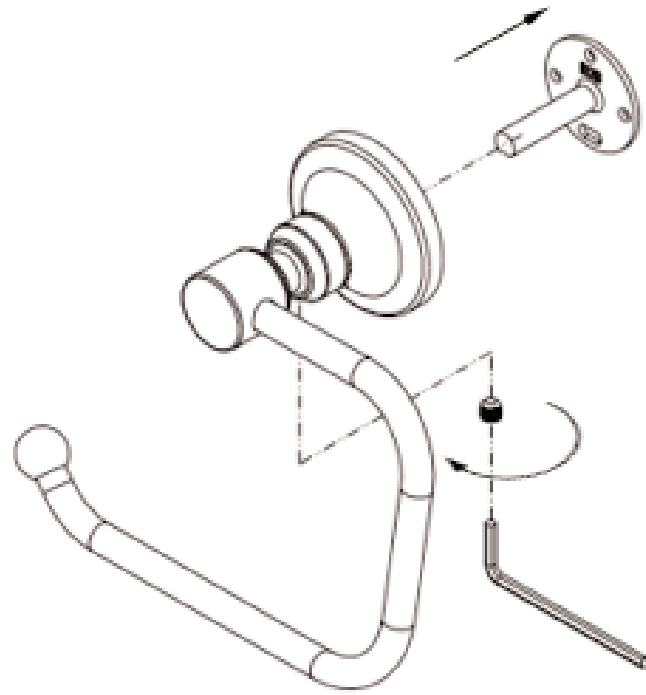

② ALIGN MOUNTING BRACKET AND MARK LOCATION

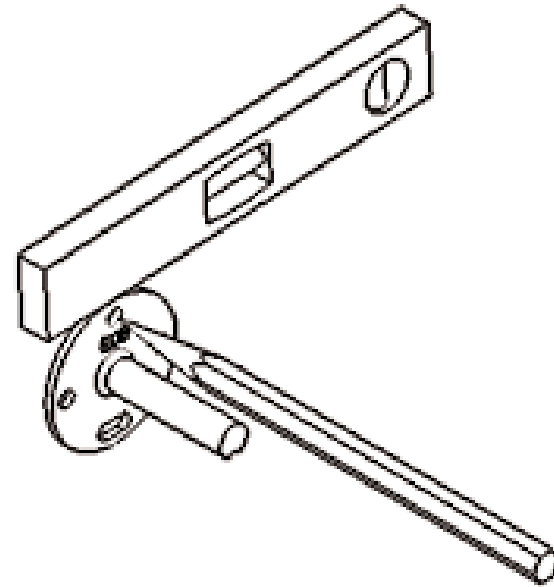

③ DRY WALL INSTALLATION

DO NOT DRILL



USE MARKS
MADE IN STEP 2

TAP IN UNTIL
THREADS ARE
REACHED

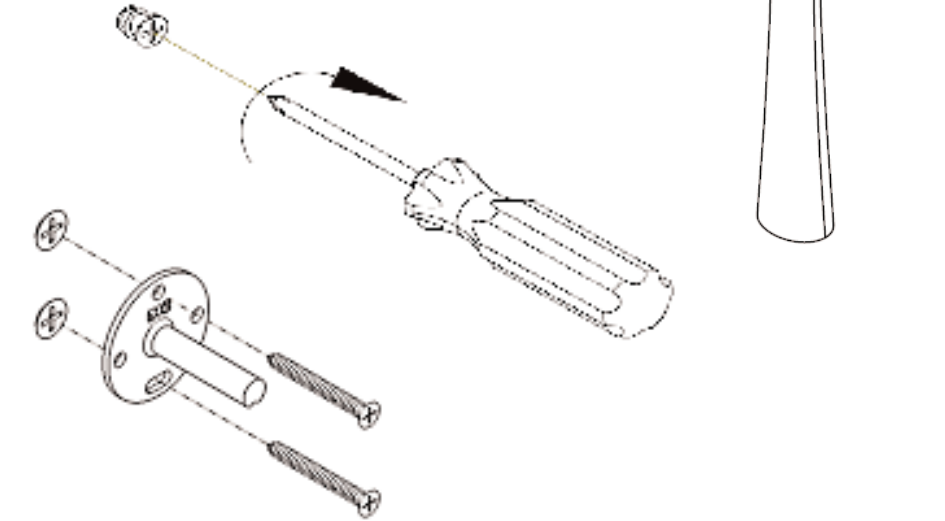

④ TILE OR SOLID WALL INSTALLATION

USE MARKS MADE IN STEP 2

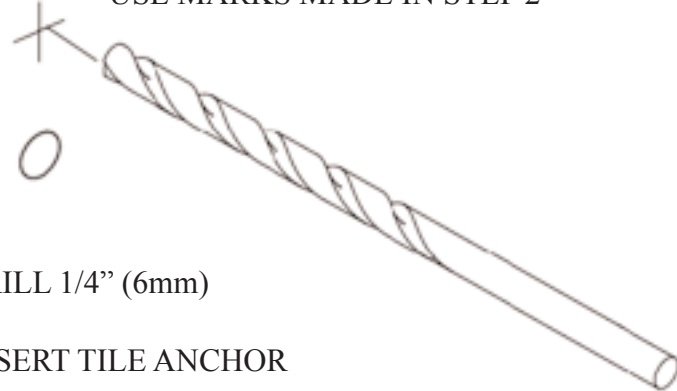

DRILL 1/4" (6mm)

INSERT TILE ANCHOR

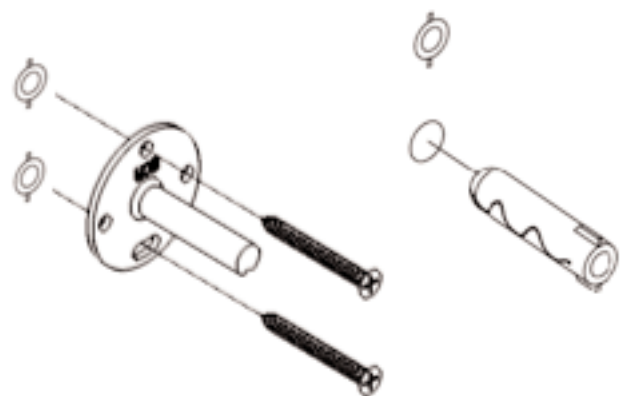

⑤ INSTALL PRODUCT ONTO BRACKET

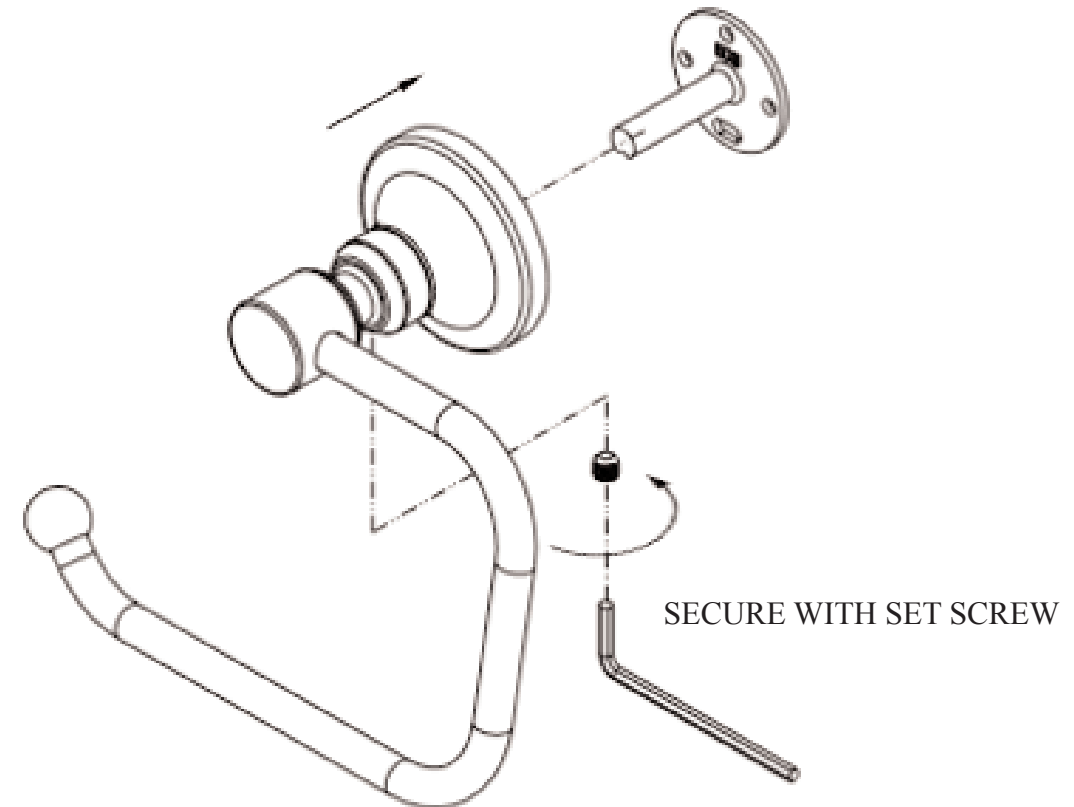

SECURE WITH SET SCREW