

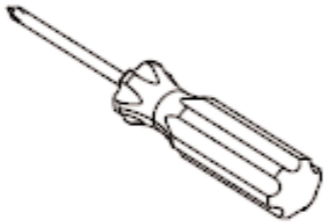







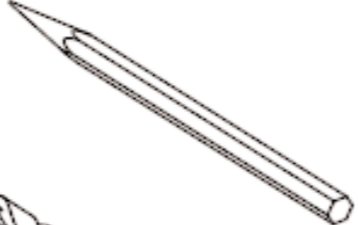

ITEMS INCLUDED		TOOLS REQUIRED	
DRY WALL ANCHOR	 X 4	PHILLIPS SCREW DRIVER	
TILE ANCHOR	 X 4	PEN / PENCIL	
#8 SCREW	 X 4	1/4" 6 mm) DRILL	
MOUNTING BRACKET	 X 2	LEVEL SET	
M6 X 6 SET SCREW	 X 2	HAMMER	
3 MM HEX KEY	 X 1		
DOUBLE POST TOILET TISSUE HOLDER	 X 1		

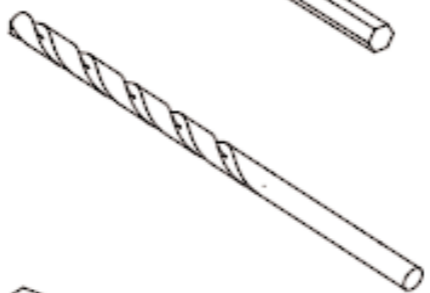
INSTALLATION INSTRUCTIONS

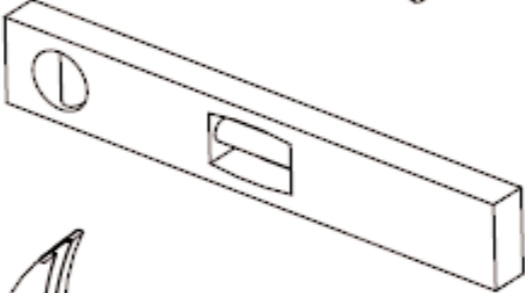
3250-1530

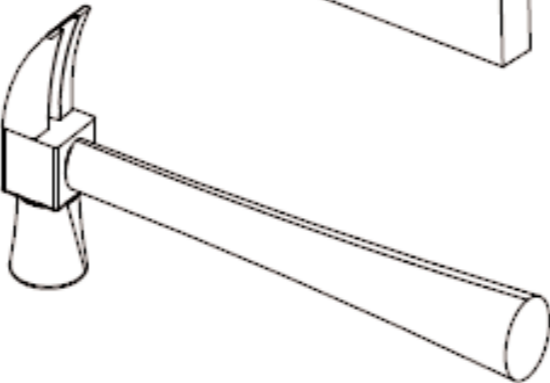
DOUBLE POST TOILET TISSUE HOLDER



2001 CARNEGIE AVE, SANTA ANA CA 92705

(949) 417-5207

WWW.NEWPORTBRASS.COM

① REMOVE MOUNTING BRACKETS

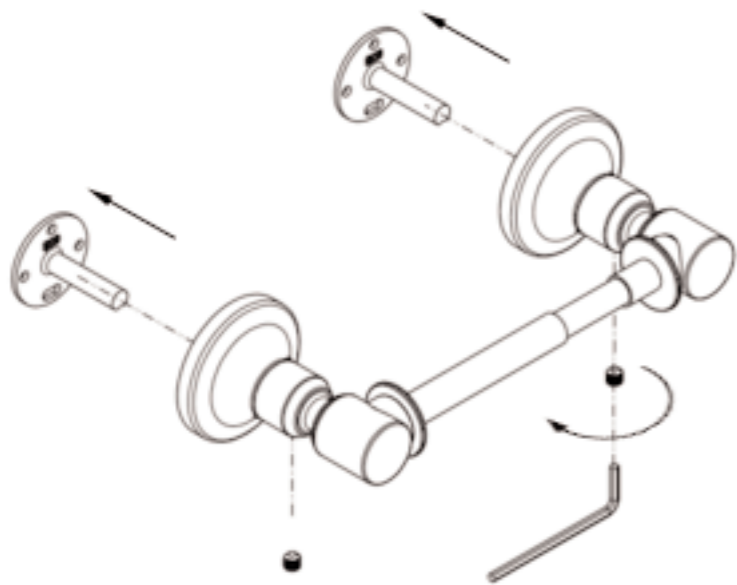

② ALIGN MOUNTING BRACKETS AND MARK LOCATION

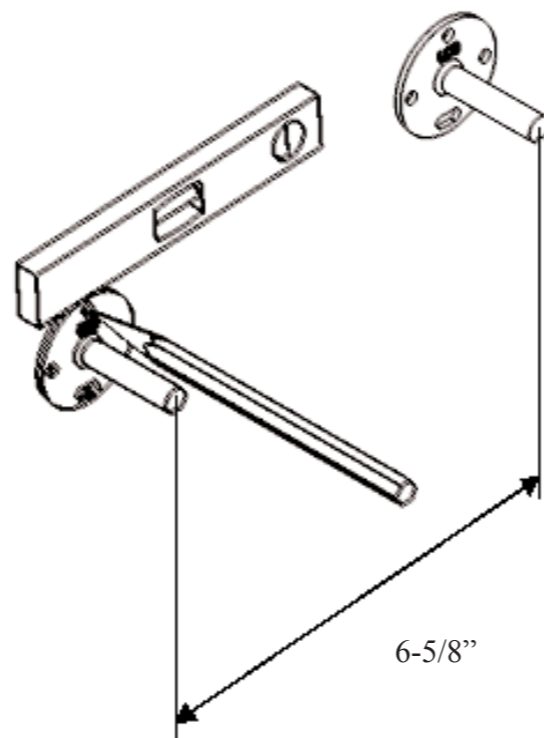

③ DRY WALL INSTALLATION

DO NOT DRILL



USE MARKS
MADE IN STEP 2

TAP IN UNTIL
THREADS ARE
REACHED

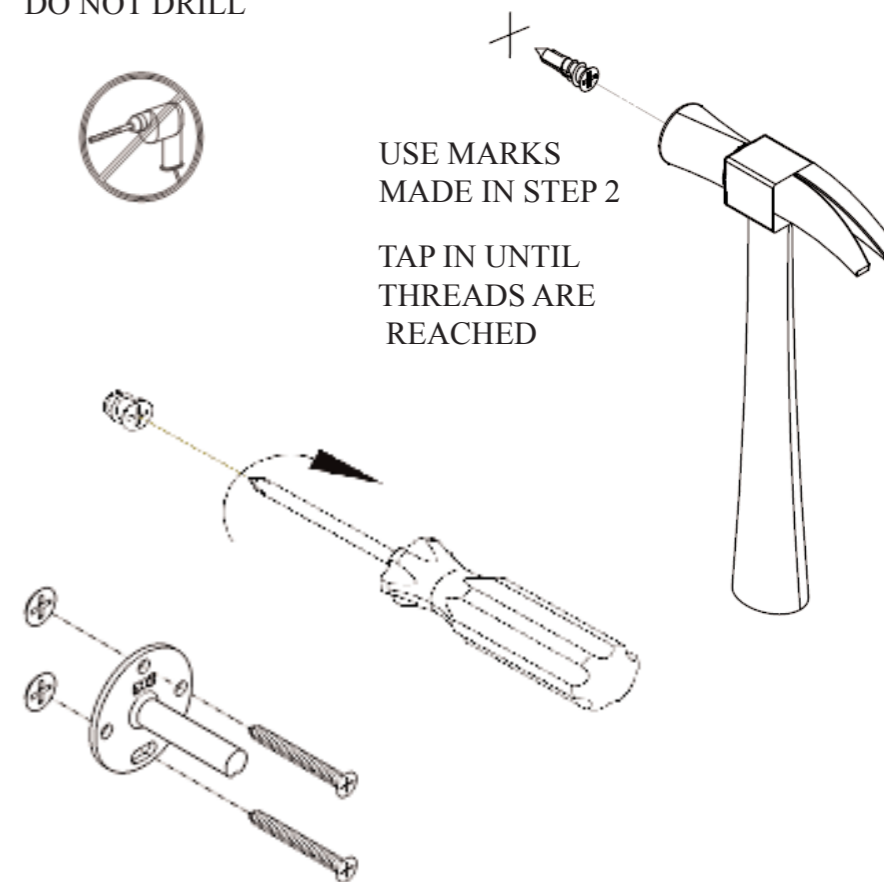

④ TILE OR SOLID WALL INSTALLATION

USE MARKS MADE IN STEP 2

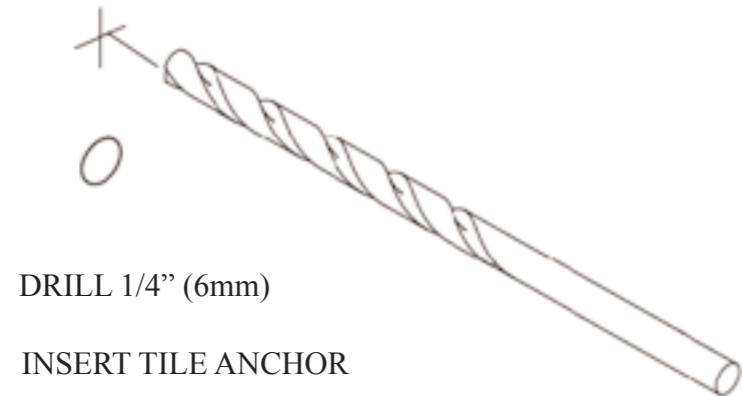

DRILL 1/4" (6mm)

INSERT TILE ANCHOR

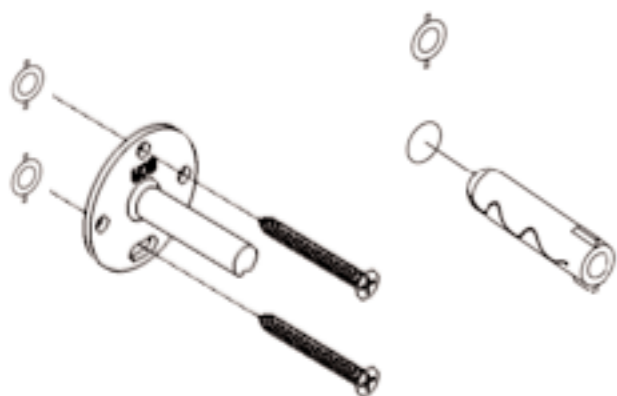

⑤ INSTALL PRODUCT ONTO BRACKETS

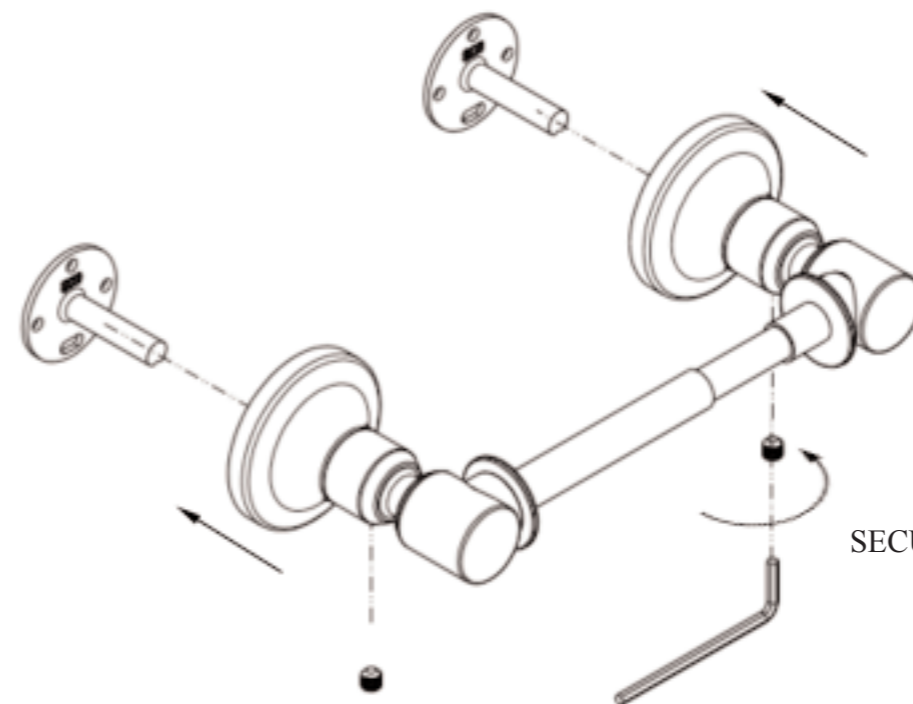

SECURE WITH SET SCREW