

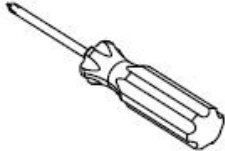







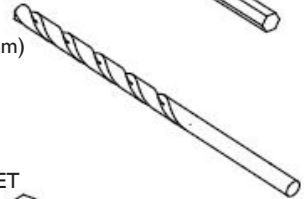

ITEMS INCLUDED		TOOLS REQUIRED	
DRY WALL ANCHOR	 X 2	PHILLIPS SCREW DRIVER	
TILE ANCHOR	 X 2	PEN / PENCIL	
#8 SCREW	 X 2	1/4" (6mm) DRILL	
MOUNTING BRACKET	 X 1	LEVEL SET	
M6 X 1 SET SCREW	 X 1	HAMMER	
3MM ALLOY STEEL HEX KEY	 X 1		
TOWEL RING	 X 1		

INSTALLATION INSTRUCTIONS

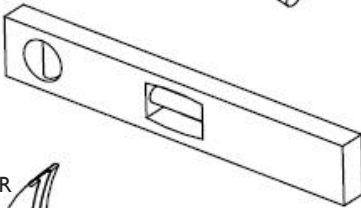
41-11

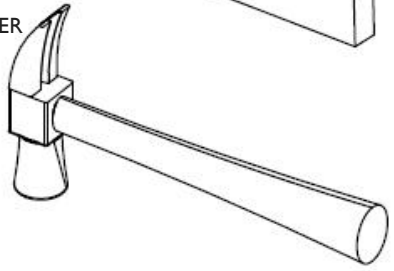
TOWEL RING

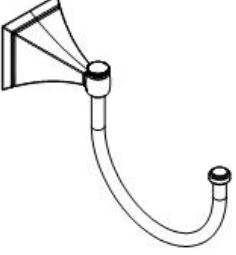
NEWPORT BRASS
 Flawless Beauty. From Faucet to Finish.™

2001 CARNEGIE AVE, SANTA ANA CA 92705
 (949) 417-5207
 (949) 417-5207
 WWW.NEWPORTBRASS.COM

① REMOVE MOUNTING BRACKET

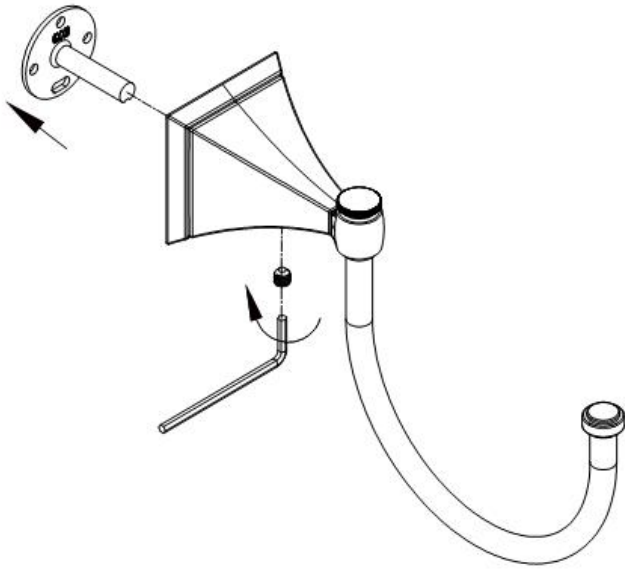

② ALIGN MOUNTING BRACKET AND MOUNT LOCATION

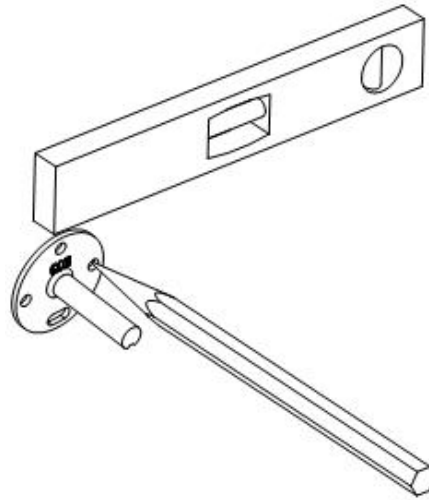

③ DRY WALL INSTALLATION

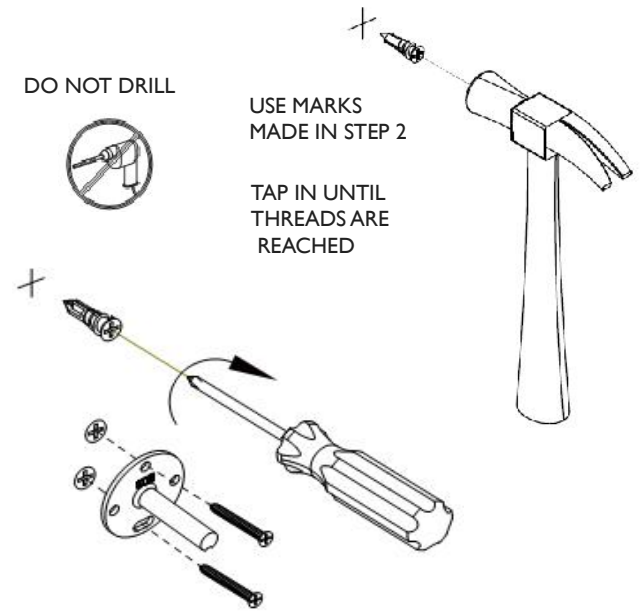

④ TILE OR SOLID WALL INSTALLATION

USE MARKS MADE IN STEP 2

DRILL 1/4" (6mm)

INSERT TILE ANCHOR

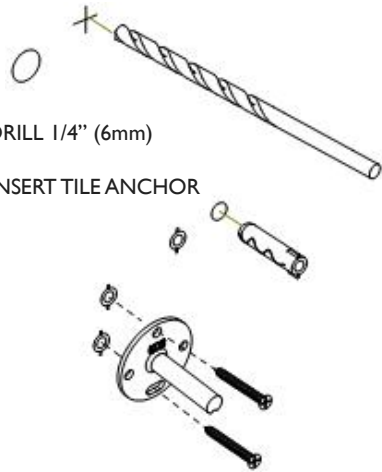

⑤ INSTALL PRODUCT ONTO BRACKET

