

NEWPORT BATH

SHOWER DIVERTER PLATE

20-513

Features

Solid brass construction
Traditional styling
For use cover 2.5" hole
Requires Newport Brass Handle Trim (many options available, sold separately)

Codes / Standards Compliance

Meets or exceeds the following at date of manufacture:

All applicable US Federal and State material regulations

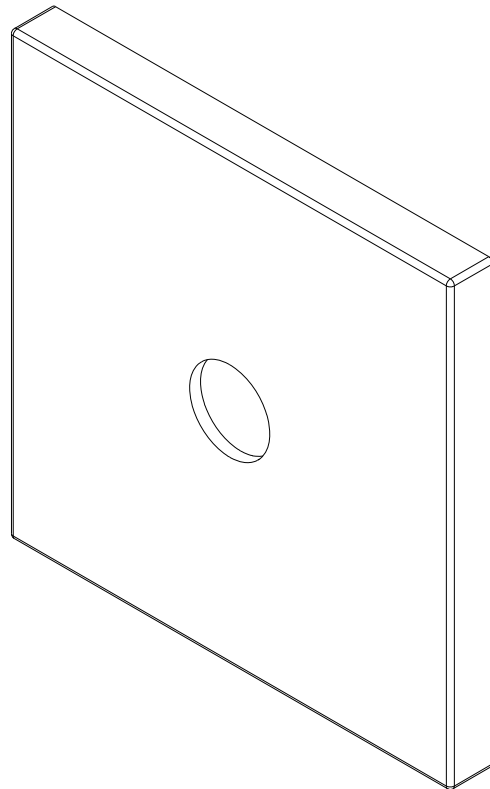

20-513

PRODUCT DIMENSIONS *(Units are in inches)*

Product Dimensions are provided for reference only. For specific product installation guidelines, please reference the Installation Instructions of the product being installed.

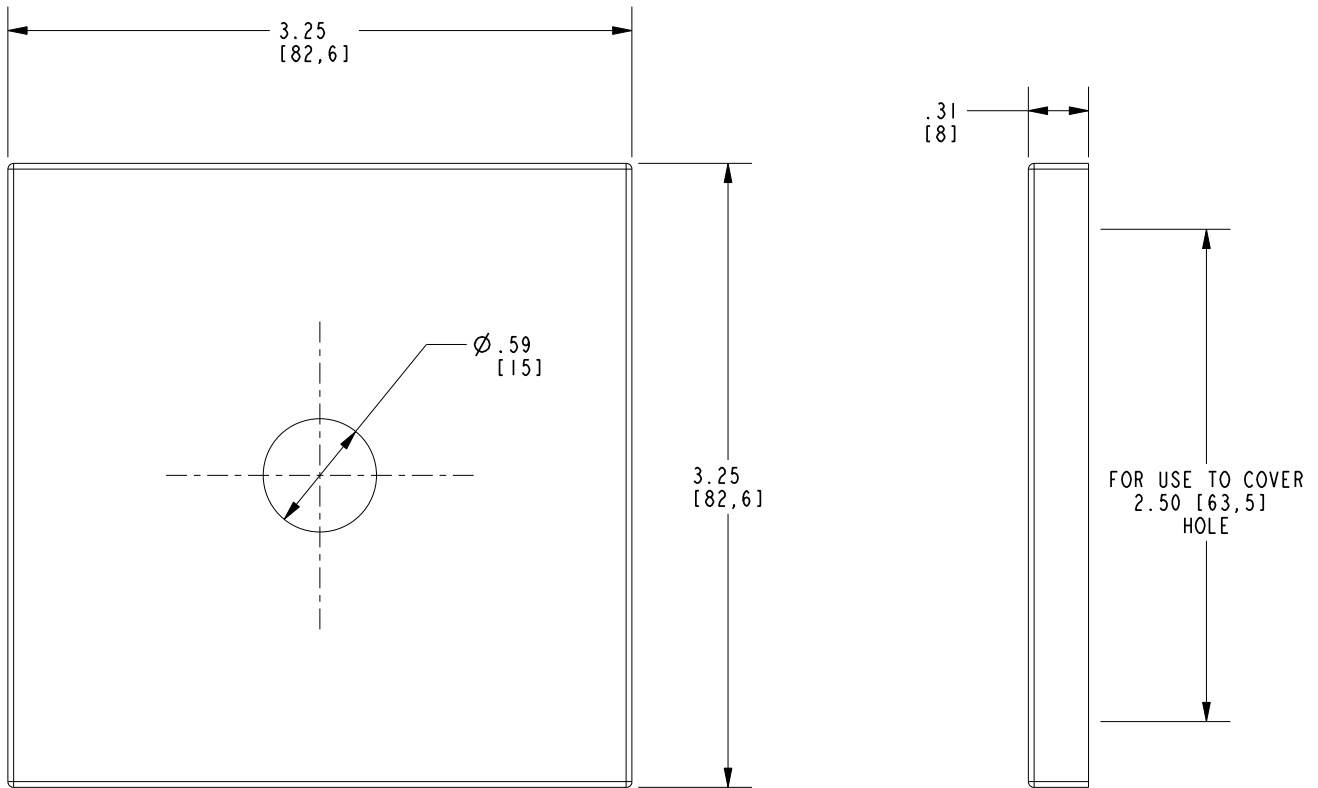

SHOWER DIVERTER PLATE

20-513

Page 2 of 2
4776
REVA

NEWPORT BRASS
Flawless Beauty. From Faucet to Finish.

t: 949.417.5207 | www.newportbrass.com
©2024 Brasstech, Inc.