

NEWPORT BRASS

TUB & SHOWER

DRAIN BODY

278A-02

Features

- ABS construction
- Not suitable for hot mop applications
- 4" IPS Inlet
- 2" Solvent Weld Outlet
- Intended for use with 6" Square Shower Drain Throat



Codes / Standards Compliance

Meets or exceeds the following at date of manufacture:

- ASME A112.18.2/CSA B125.2
- IAPMO / cUPC
- IPC
- All applicable US Federal and State material regulations

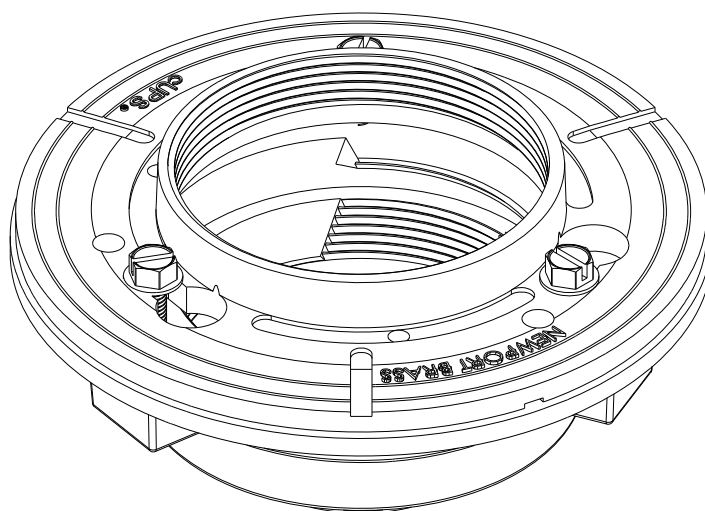

NEWPORT BRASS

PRODUCT DIMENSIONS *(Units are in inches)*

Product Dimensions are provided for reference only. For specific product installation guidelines, please reference the Installation Instructions of the product being installed.

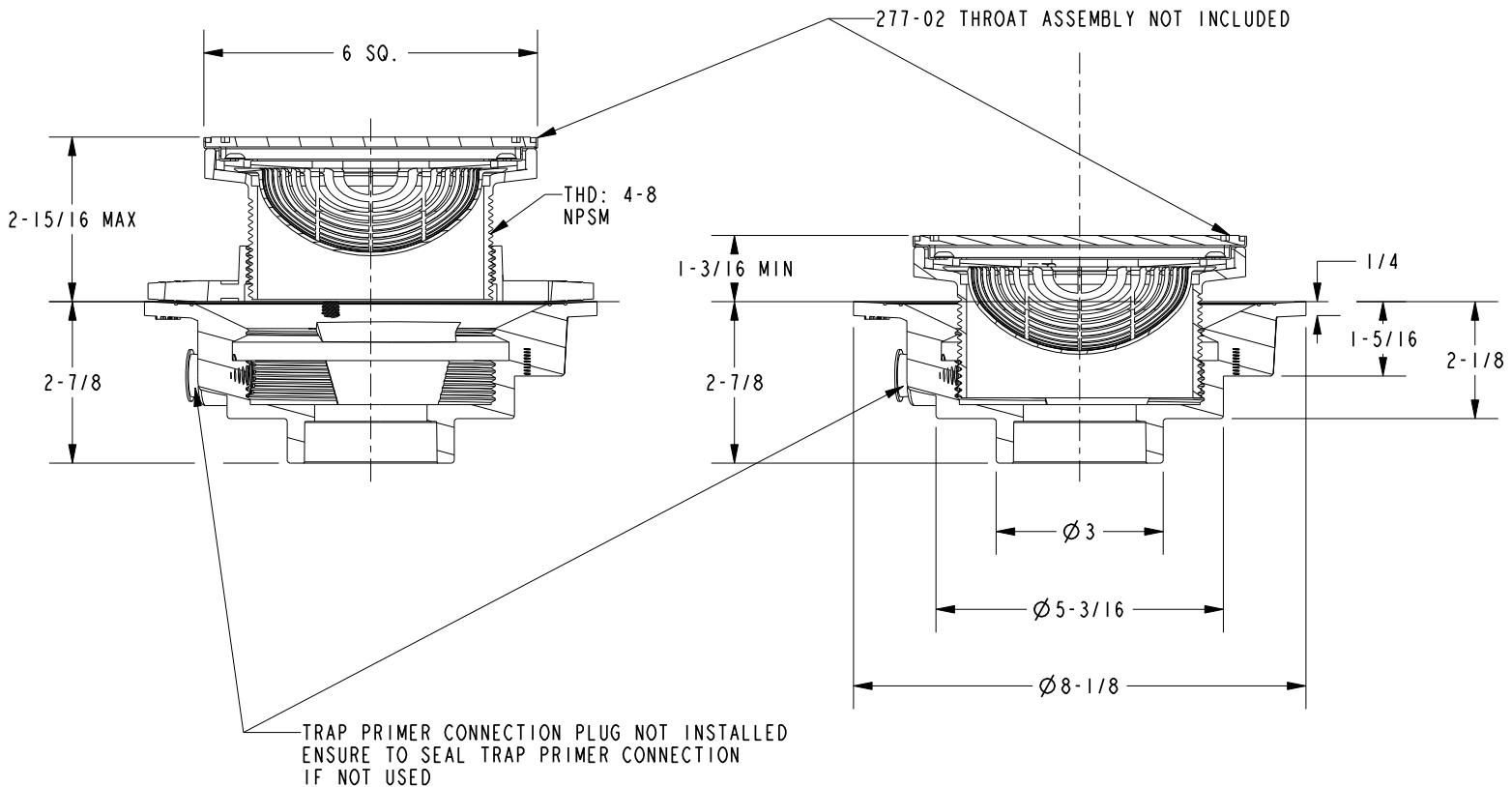

DRAIN BODY
278A-02