



NEWPORT BRASS

EST.1989



2026 PRICEBOOK

NUMERICAL INDEX

KITCHEN	PAGE
ADAMS	20
CHESTERFIELD	24
EAST LINEAR	32
GAVIN	38
HEANEY	42
JACOBAN	46
JETER	50
METROPOLE	54
MUNCY	58
MUNCY (BLACK X SATIN BRASS-PVD)	62
NADYA	66
PARDEES NEW	68
SEAGER	72
STRIPLING	76
TAFT	80
VESPERA	84
ZEMORA	86
PREP/BAR FAUCETS	90
KITCHEN ACCESSORIES	98

BATH	PAGE
ALEXANDRIA	110
AMISA	114
ASTOR	118
AYLESBURY	128
CHESTERFIELD	138
CLEMENS	150
DORRANCE	156
EAST LINEAR	162
GRIFFEY	176
ITHACA	182
JACOBAN	188
JOFFREY	196
KIMBELL NEW	200
MALVINA	206
METROPOLE	212
MIRO	222
MUNCY	228
PARDEES	234
PAVANI	240
SEAPORT	250
SECANT	256
TAFT	268
TOLMIN	272
VANDER	278
VICTORIA	282

TUB & SHOWER	PAGE
1/2" GENERAL GUIDELINES FOR PLANNING AND LAYOUT	292
3/4" GENERAL GUIDELINES FOR PLANNING AND LAYOUT	298
3/4" THERMOSTATIC VALVE	302
FREESTANDING TUB FILLERS	304
DECORATIVE DRAINS	308
TILE IN DRAIN	311
SHOWERHEAD, ARMS & FLANGES	312
HAND SHOWERS	318
HAND SHOWER SETS	320
SLIDE BAR HAND SHOWER KITS	322
SLIDE BARS	324
SHOWER SLIDER KITS FOR GRAB BARS	326
SHOWER PARTS	328
BIDETS	330
BODY SPRAYS	332
TUB SPOUTS	334
SHOWER TRIM VALVES	338
DIVERTER / FLOW CONTROL TRIM	340
BP TUB & SHOWER TRIM SETS	350
BASKETS	354
GRAB BARS	358
SPECIALTY BATHROOM ACCESSORIES	361
TANK LEVERS	362

FITTINGS	PAGE
FITTINGS - KITCHEN	368
FITTINGS - TUB & SHOWER	369
FITTINGS - TANK & LAVATORY	374

INDEX	PAGE
NUMERICAL PARTS INDEX	380

FINISH OFFERINGS

Design at Newport Brass begins with solid brass, an enduring material revered for its strength, beauty, and timeless form. With a choice of 22 hand-applied finishes across all collections, each piece becomes part of a home's personal story. From the warm glow of brass, copper, and bronze to the cool luster of nickel, chrome, and steel, our broad palette and meticulous craftsmanship bring character, and personality to every fixture.

Surfaces are brought to life through a range of refined techniques. Because we work exclusively in brass, we're able to offer a living finish that evolves naturally, deepening in patina over time. For a look rich with dimension, our antique finish is skillfully buffed to reveal its refined, hand-crafted character. When a sleek, uniform appearance is desired, powder coating, plating, or PVD create a finish of enduring brilliance and precision.

GROUP I



Polished Chrome
(26)

GROUP II



Forever Brass - PVD
(01)



Uncoated Polished
Brass - Living
(03N)



Satin Brass - PVD
(04)



Oil Rubbed Bronze
(10B)



Polished Nickel -
Natural (15)

GROUP III



Satin Bronze - PVD
(10)



Polished Nickel - PVD
(15P)



Polished Gold - PVD
(24)



French Gold - PVD
(24A)



Satin Gold - PVD
(24S)

BRASS PROTECTION



98000 List \$39

Brass Protech is exclusively made to clean, polish and protect Newport Brass products.

01* FOREVER BRASS (PVD)
 03N** UNCOATED POLISHED BRASS
 034**** AGED BRASS
 04* SATIN BRASS (PVD)
 06 ANTIQUE BRASS
 07 ENGLISH BRONZE
 08A ANTIQUE COPPER
 10* SATIN BRONZE (PVD)

10B OIL RUBBED BRONZE
 VB VENETIAN BRONZE
 15 POLISHED NICKEL
 15A ANTIQUE NICKEL
 15P* POLISHED NICKEL (PVD)
 15S* SATIN NICKEL (PVD)
 20* STAINLESS STEEL (PVD)
 24* POLISHED GOLD (PVD)

24A* FRENCH GOLD (PVD)
 24S* SATIN GOLD (PVD)
 26 POLISHED CHROME
 30 MIDNIGHT CHROME
 52 MATTE WHITE
 56 FLAT BLACK



Satin Nickel - PVD
(15S)



Stainless Steel - PVD
(20)



Midnight Chrome
(30)



Matte White
(52)



Flat Black
(56)

GROUP IV



Aged Brass
(034)



Antique Brass
(06)



English Bronze
(07)



Antique Copper
(08A)



Antique Nickel
(15A)



Venetian Bronze
(VB)

A close-up, macro photograph of a gold watch case back. The image is dominated by warm, golden tones and sharp reflections. In the lower right, the case back is visible, featuring the number '1000' engraved in a circular pattern. Below it, the number '1125' is also visible. The watch's crown and pushers are partially visible in the upper right corner. The overall composition is abstract and emphasizes the texture and craftsmanship of the gold metal.

LEGACY REFINED



FOR MODERN LIVING

NEWPORT BRASS

FOUNDED IN 1989 IN NEWPORT BEACH, CALIFORNIA, NEWPORT BRASS EMERGED FROM A SIMPLE BELIEF: THAT THE OBJECTS WE LIVE WITH SHOULD BE AS ENDURING AS THEY ARE BEAUTIFUL. ROOTED IN THE QUIET ELEGANCE OF COASTAL LIVING, OUR ORIGIN CONTINUES TO INFORM OUR SENSIBILITY—WHERE AMERICAN CRAFTSMANSHIP MEETS TIMELESS DESIGN, AND WHERE REFINEMENT IS NEVER MISTAKEN FOR EXCESS. THAT SPIRIT OF BALANCE—BETWEEN HERITAGE AND MODERNITY, RESTRAINT AND PRESENCE—REMAINS AT THE CORE OF EVERYTHING WE CREATE.

OUR PRODUCTS ARE MORE THAN FUNCTIONAL COMPONENTS; THEY ARE SCULPTURAL STATEMENTS DESIGNED TO ANCHOR A SPACE. EACH ONE IS CAST IN SOLID BRASS, ENGINEERED WITH PRECISION, AND FINISHED BY HAND—INTENDED NOT JUST TO SHINE TODAY, BUT TO REMAIN RELEVANT FOR GENERATIONS. WE BELIEVE PERMANENCE IS A VIRTUE, AND THAT TRUE LUXURY REVEALS ITSELF IN DETAILS: THE WEIGHT OF A HANDLE, THE ARC OF A SPOUT.

INSPIRED BY CLASSIC AMERICAN ARCHITECTURE AND THE CLARITY OF MODERN FORM, OUR DESIGN LANGUAGE BLENDS EAST COAST TRADITION WITH WEST COAST EASE. IT'S A PHILOSOPHY THAT VALUES LONGEVITY OVER TREND, CHARACTER OVER COMPLICATION. WE STAND FOR CRAFTSMANSHIP THAT ENDURES—QUIETLY RESISTING THE DISPOSABLE, AND PRESERVING THE BEAUTY OF THINGS MADE WELL.

NEWPORT BRASS IS FOR THOSE WHO VIEW THE HOME AS A REFLECTION OF VALUES, NOT JUST AESTHETICS. FOR DESIGNERS AND HOMEOWNERS WHO SEEK PIECES WITH PROVENANCE AND PURPOSE—FIXTURES THAT LIVE SEAMLESSLY BETWEEN PAST AND PRESENT, DESIGNED TO STAND THE TEST OF TIME BOTH STYLISTICALLY AND STRUCTURALLY. REFINED, ARCHITECTURAL, AND CRAFTED WITH INTENTION, NEWPORT BRASS EXISTS NOT TO FOLLOW TRENDS, BUT TO HELP SHAPE A LASTING SENSE OF PLACE.



Newport Brass speaks to the enduring spirit of East Coast design – where history, architecture, and craftsmanship carry a quiet gravitas. Our fixtures honor that sensibility through forms that balance tradition with clarity, echoing the character of coastal shingle homes, brownstones, and landmark interiors shaped over generations.

Crafted in solid brass and finished with meticulous care, each piece reflects a commitment to permanence and the belief that true luxury lives in proportion, detail, and restraint. For those who value heritage as much as innovation, Newport Brass offers fixtures that anchor a home with lasting purpose and a sense of considered refinement.

EAST COAST





TRADITION

Newport Brass was born on the West Coast, shaped by the light, ease, and understated elegance of coastal California living. Our design philosophy reflects that origin – open, modern, and effortlessly refined, with forms that honor simplicity without sacrificing substance. Crafted in solid brass and made to endure, our fixtures express a balance of precision and warmth, echoing the

architecture and relaxed sophistication of the Pacific. For those who value spaces that feel calm, intentional, and quietly luxurious, Newport Brass offers pieces designed to live seamlessly across generations – rooted in quality, guided by clarity, and made to elevate everyday living with quiet confidence.



WEST COAST



EASE



Handmade in solid brass, our kitchen faucets bring enduring beauty, function, and character to the spaces where daily life unfolds. From modern forms to traditional silhouettes, our signature collections invite personal expression, with every style available in all 22 of our hand-applied finishes. Thoughtfully crafted and meticulously detailed, each piece reflects the artistry and material integrity at the heart of our timeless design philosophy.

A considered range of configurations ensures the right solution for every environment. Pull-downs, bridge styles, single-hole and three-hole designs, along with dedicated prep and bar faucets allow every detail to be shaped with intention. Pot fillers, water dispensers, and refined accessories complete the composition creating a luxurious kitchen aesthetic that elevates daily rhythms and endures for generations.



KITCHEN

KITCHEN COLLECTIONS

NUMERICAL INDEX

COLLECTION	PAGE
ADAMS	20
CHESTERFIELD	24
EAST LINEAR	32
GAVIN	38
HEANEY	42
JACOBAN	46
JETER	50
METROPOLE	54
MUNCY	58
MUNCY (BLACK X SATIN BRASS-PVD)	62
NADYA	66

COLLECTION	PAGE
PARDEES	68
SEAGER	72
STRIPLING	76
TAFT	80
VESPERA	84
ZEMORA	86
PREP/BAR FAUCETS	90
KITCHEN ACCESSORIES	98

KITCHEN COLLECTIONS

ADAMS
PAGE 20



3170-5103

CHESTERFIELD
PAGE 24



1030-5103

EAST LINEAR
PAGE 32



1500-5103

GAVIN
PAGE 38



3210-5103

HEANEY
PAGE 42



3190-5113

JACOBEBAN
PAGE 46



2470-5103

JETER
PAGE 50

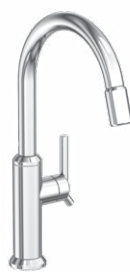

3200-5113

METROPOLE
PAGE 54



1200-5103

MUNCY
PAGE 58



3290-5113

MUNCY (BLACK X
SATIN BRASS) PAGE 62



3290-5113

NADYA
PAGE 66



2510-5103

PARDEES
PAGE 68



3230-5143

SEAGER
PAGE 72



3180-5113

STRIPLING
PAGE 76



3310-5103

TAFT
PAGE 80



2940-5103

VESPERA
PAGE 84



2500-5123

ZEMORA
PAGE 86



3160-5103

PREP/BAR FAUCETS
PAGE 90



1030-5223

KITCHEN
ACCESSORIES
PAGE 98



100

ADAMS



ADAMS

		I	II	III	IV	
3170-5103		Pull-Down Kitchen Faucet 10.50" (26.7cm) spout height at outlet 8.57" (21.8cm) spout reach (c-c) 17.53" overall height 1.8 gallons (6.8 liters) per minute maximum flow rate	\$1588	\$1985	\$2303	\$2382
3170-5203		Prep/Bar Pull-Down Faucet 8.28" (21.0cm) spout height at outlet 7.47" (19.0 cm) spout reach (c-c) 14.93" overall height 1.8 gallons (6.8 liters) per minute maximum flow rate	\$1588	\$1985	\$2303	\$2382
3170-5603		Hot and Cold Water Dispenser 6.73" (17cm) spout height at outlet 4.74" (12.0 cm) spout reach (c-c) HOT WATER TANK #5-036 SOLD SEPARATELY	\$1134	\$1418	\$1645	\$1701
3170-5613		Hot Water Dispenser 6.73" (17cm) spout height at outlet 4.74" (12.0cm) spout reach (c-c) HOT WATER TANK #5-036 SOLD SEPARATELY	\$883	\$1104	\$1281	\$1325
3170-5623		Cold Water Dispenser 6.73" (17cm) spout height at outlet 4.74" (12.0cm) spout reach c-c	\$735	\$919	\$1066	\$1103
6-028		Universal Traditional Air Gap, Reverse Osmosis	\$235	\$294	\$341	\$353
3170-5503		Pot Filler - Wall Mount 4.37" (11.1cm) spout downward offset from wall inlet center 21.39" (54.3cm) pivoting spout reach from inlet valve (c-c) 3.51" (8.9cm) pivoting inlet valve offset (wall-center) Two shut off valves Twin knuckles	\$1591	\$1989	\$2307	\$2387
3180-5711		Air Gap Kit IAPMO UPC® listed	\$194	\$243	\$282	\$291

ADAMS

			I	II	III	IV
3170-5811		Soft Touch Air Activated Disposer Switch Plugs into a standard 120VAC wall outlet	\$374	\$468	\$543	\$561
3170-5721		Soap/Lotion Dispenser Requires 1-1/4" to 1-11/16" through hole Accommodates 2-3/8" maximum deck thickness	\$398	\$498	\$578	\$597
20-373		Soap/Lotion Replacement Head	\$216	\$270	\$313	\$324
125-8		Soap/Lotion Pump	\$67	—	—	—
125-9		Soap/Lotion - Replacement Bottle	\$6	—	—	—



Adams Pull-Down Kitchen Faucet in Stainless Steel PVD (20) (see page 20)

CHESTERFIELD









CHESTERFIELD

			I	II	III	IV
1030-5103		Pull-Down Kitchen Faucet 10.31" (26.2cm) spout height at outlet 8.58" (21.8cm) spout reach (c-c) 17.43" overall height 1.8 gallons (6.8 liters) per minute maximum flow rate	\$1503	\$1879	\$2180	\$2255
1030-5173		Pull-Down Kitchen Faucet Trigger Spray. Slim body 10.53" (26.7cm) spout height at outlet 8.78" (22.3cm) spout reach (c-c) 18.93" overall height 1.8 gallons (6.8 liters) per minute maximum flow rate	\$1712	\$2140	\$2483	\$2568
1030-7173		Pull-Down Kitchen Faucet Trigger Spray Extended Reach 12.61" (32.0cm) spout height at outlet 11.19" (28.4 cm) spout reach (c-c) 20.60" overall height 1.8 gallons (6.8 liters) per minute maximum flow rate	\$2165	\$2707	\$3140	\$3356
972		Kitchen Faucet. Lever Handles 5.83" (14.8cm) spout height at outlet 9.46" (24.0 cm) spout reach (c-c) For 8" (20.3cm) centers - maximum 20" (50.8cm) 1.8 gallons (6.8 liters) per minute maximum flow rate	\$1402	\$1753	\$2033	\$2103
942		Kitchen Faucet. Cross Handles. 5.83" (14.8cm) spout height at outlet 9.46" (24.0 cm) spout reach (c-c) For 8" (20.3cm) centers - maximum 20" (50.8cm) 1.8 gallons (6.8 liters) per minute maximum flow rate	\$1402	\$1753	\$2033	\$2103
973		Kitchen Faucet with Side Spray. Lever Handles. 5.56" (14.1 cm) spout height at outlet 9.49" (24.1 cm) spout reach (c-c) For 8" (20.3cm) centers - maximum 20" (50.8cm) 1.8 gallons (6.8 liters) per minute maximum flow rate	\$1787	\$2234	\$2592	\$2681
943		Kitchen Faucet with Side Spray. Cross Handles. 5.56" (14.1 cm) spout height at outlet 9.49" (24.1 cm) spout reach (c-c) For 8" (20.3cm) centers - maximum 20" (50.8cm) 1.8 gallons (6.8 liters) per minute maximum flow rate	\$1787	\$2234	\$2592	\$2681
1030-5463		Kitchen Bridge Pull-Down Faucet C-spout. Lever Handles. 8.28" (21.0cm) spout height at outlet 8.58" (21.8cm) spout reach (c-c) For 8" (20.3cm) centers 1.8 gallons (6.8 liters) per minute maximum flow rate	\$1838	\$2298	\$2666	\$2757





CHESTERFIELD

		I	II	III	IV	
1030-5462		Kitchen Bridge Pull-Down Faucet C-spout. Cross Handles. 8.28" (21.0cm) spout height at outlet 8.58" (21.8cm) spout reach (c-c) For 8" (20.3cm) centers 1.8 gallons (6.8 liters) per minute maximum flow rate	\$1838	\$2298	\$2666	\$2757
9461		Kitchen Bridge Faucet Swivel Spout. Lever Handles 6.38" (16.2cm) spout height at outlet 9.46" (24.0cm) spout reach (c-c) For 8" (20.3cm) centers 1.8 gallons (6.8 liters) per minute maximum flow rate	\$1578	\$1973	\$2289	\$2367
9457		Kitchen Bridge Faucet C-spout. Lever Handles 9" (22.8cm) spout height at outlet 9" (22.8cm) spout reach (c-c) For 8" (20.3cm) centers 1.8 gallons (6.8 liters) per minute maximum flow rate	\$1745	\$2182	\$2531	\$2618
9463		Kitchen Bridge Faucet C-spout. Lever Handles. 9" (22.8cm) spout height at outlet 7.12" (18.1cm) min to 9" (22.8cm) max spout reach (c-c) For 8" (20.3cm) centers - Maximum 9.62" (24.4cm) 1.8 gallons (6.8 liters) per minute maximum flow rate	\$2000	\$2500	\$2900	\$3000
9464		Kitchen Bridge Faucet C-spout. Cross Handles. 9" (22.8cm) spout height at outlet 7.12" (18.1cm) min to 9" (22.8cm) max spout reach (c-c). For 8" (20.3cm) centers - Maximum 9.62" (24.4cm) 1.8 gallons (6.8 liters) per minute maximum flow rate	\$2000	\$2500	\$2900	\$3000
9455		Kitchen Bridge Faucet C-spout. Cross Handles. 9" (22.8cm) spout height at outlet 9" (22.8cm) spout reach (c-c) For 8" (20.3cm) centers 1.8 gallons (6.8 liters) per minute maximum flow rate	\$1782	\$2228	\$2584	\$2673
945		Kitchen Bridge Faucet Swivel spout 6.38" (16.2cm) spout height at outlet 9.46" (24.0cm) spout reach (c-c) For 8" (20.3cm) centers 1.8 gallons (6.8 liters) per minute maximum flow rate	\$1551	\$1939	\$2249	\$2327

CHESTERFIELD

		I	II	III	IV	
9451		Kitchen Bridge Faucet Swivel spout 6.52" (16.6cm) spout height at outlet 8.51" (21.6cm) min to 10.38" (26.4cm) max. spout reach (c-c) For 8" (20.3) centers - maximum 9.62" (24.4cm) 1.8 gallons (6.8 liters) per minute maximum flow rate	\$1698	\$2123	\$2463	\$2547
9458		Kitchen Bridge Faucet with Side Spray C-spout. Lever Handles 9" (22.8cm) spout height at outlet 9" (22.8cm) spout reach (c-c) For 8" (20.3cm) centers 1.8 gallons (6.8 liters) per minute maximum flow rate	\$2445	\$3057	\$3546	\$3668
9459		Kitchen Bridge Faucet with Side Spray C-spout. Lever Handles. 9" (22.8cm) spout height at outlet 7.12" (18.1cm) min to 9" (22.8cm) max spout reach (c-c) For 8" (20.3cm) centers - Maximum 9.62" (24.4cm) 1.8 gallons (6.8 liters) per minute maximum flow rate	\$2503	\$3129	\$3630	\$3755
9462		Kitchen Bridge Faucet with Side Spray Swivel Spout. Lever Handles 6.38" (16.2cm) spout height at outlet 9.46" (24.0cm) spout reach (c-c) For 8" (20.3cm) centers 1.8 gallons (6.8 liters) per minute maximum flow rate	\$2074	\$2593	\$3008	\$3111
9453-I		Kitchen Bridge Faucet with Side Spray Swivel spout. Lever Handles 6.52" (16.6cm) spout height at outlet 8.51" (21.6 cm) min. to 10.38" (26.4cm) spout reach (c-c) For 8" (20.3cm) centers - Maximum 9.62" (24.4cm) 1.8 gallons (6.8 liters) per minute maximum flow rate	\$2240	\$2800	\$3248	\$3360
946		Kitchen Faucet with Side Spray 5.56" (14.1 cm) spout height at outlet 9.49" (24.1 cm) spout reach (c-c) For 8" (20.3cm) centers - maximum 20" (50.8cm) 1.8 gallons (6.8 liters) per minute maximum flow rate	\$1787	\$2234	\$2592	\$2681
9456		Kitchen Bridge Faucet with Side Spray C-spout. Cross Handles. 9" (22.8cm) spout height at outlet 9" (22.8cm) spout reach (c-c) For 8" (20.3cm) centers 1.8 gallons (6.8 liters) per minute maximum flow rate	\$2340	\$2925	\$3393	\$3510

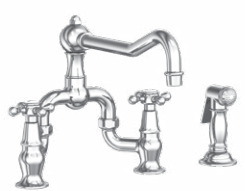
CHESTERFIELD

		I	II	III	IV	
9460		Kitchen Bridge Faucet with Side Spray C-spout. Cross Handles. 9" (22.8cm) spout height at outlet 7.12" (18.1cm) min to 9" (22.8cm) max spout reach (c-c) For 8" (20.3cm) centers - Maximum 9.62" (24.4cm) 1.8 gallons (6.8 liters) per minute maximum flow rate	\$2503	\$3129	\$3630	\$3755
945-I		Kitchen Bridge Faucet with Side Spray Swivel spout 6.38" (16.2cm) spout height at outlet 9.46" (24.0cm) spout reach (c-c) For 8" (20.3cm) centers 1.8 gallons (6.8 liters) per minute maximum flow rate	\$2041	\$2552	\$2960	\$3062
9452-I		Kitchen Bridge Faucet with Side Spray Swivel spout. Cross Handles 6.52" (16.6cm) spout height at outlet 8.51" (21.6 cm) min. to 10.38" (26.4cm) spout reach (c-c) For 8" (20.3cm) centers - Maximum 9.62" (24.4cm) 1.8 gallons (6.8 liters) per minute maximum flow rate	\$2240	\$2800	\$3248	\$3360
945I-I		Kitchen Bridge Faucet with Side Spray Swivel spout 6.52" (16.6cm) spout height at outlet 8.51" (21.6cm) min to 10.38" (26.4cm) max. spout reach (c-c) For 8" (20.3) centers - maximum 9.62" (24.4cm) 1.8 gallons (6.8 liters) per minute maximum flow rate	\$2240	\$2800	\$3248	\$3360
1038		Prep/Bar Faucet 10" (25.4cm) spout height at outlet 5.27" (13.4cm) spout reach (c-c) 13.31" overall height 1.8 gallons (6.8 liters) per minute maximum flow rate	\$1359	\$1699	\$1971	\$2039
1030-5223		Prep/Bar Pull Down Faucet 8.18" (20.8cm) spout height at outlet 7.47" (19.0cm) spout reach (c-c) 14.83" overall height 1.8 gallons (6.8 liters) per minute maximum flow rate	\$1503	\$1879	\$2180	\$2255
1030-5233		Prep/Bar Faucet 7.97" (20.2cm) spout height at outlet 7.00" (17.8cm) spout reach (c-c) 13.54" overall height 1.8 gallons (6.8 liters) per minute maximum flow rate	\$1503	\$1879	\$2180	\$2255

CHESTERFIELD

		I	II	III	IV	
938		Prep/Bar Faucet 5.23" (13.3cm) spout height at outlet 6.95" (17.7cm) spout reach (c-c) 7.97" overall height 1.8 gallons (6.8 liters) per minute maximum flow rate	\$1359	\$1699	\$1971	\$2039
928		Prep/Bar Faucet 8.37" (21.3cm) spout height at outlet 5.27" (13.4cm) spout reach (c-c) 11.68" overall height 1.8 gallons (6.8 liters) per minute maximum flow rate	\$1359	\$1699	\$1971	\$2039
1008		Prep/Bar Faucet 7.12" (18.1cm) spout height at outlet 8.45" (21.4cm) spout reach (c-c) 11.01" overall height 1.8 gallons (6.8 liters) per minute maximum flow rate	\$1404	\$1755	\$2036	\$2106
108		Hot and Cold Water Dispenser 5.82" (14.8cm) spout height at outlet 5.18" (13.2cm) spout reach (c-c) HOT WATER TANK #5-036 SOLD SEPARATELY.	\$1120	\$1400	\$1624	\$1680
1030-5603		Hot and Cold Water Dispenser 6.57" (16.7cm) spout height at outlet 4.8" (12.2cm) spout reach (c-c) HOT WATER TANK #5-036 SOLD SEPARATELY	\$1134	\$1418	\$1645	\$1701
108H		Hot Water Dispenser 5.82" (14.8cm) spout height at outlet 5.18" (13.2cm) spout reach (c-c) HOT WATER TANK #5-036 SOLD SEPARATELY	\$861	\$1077	\$1249	\$1292
1030-5613		Hot Water Dispenser 6.57" (16.7cm) spout height at outlet 4.8" (12.2cm) spout reach (c-c) WATER TANK #5-036 SOLD SEPARATELY	\$883	\$1104	\$1281	\$1325

CHESTERFIELD

			I	II	III	IV
108c		Cold Water Dispenser 5.82" (14.8cm) spout height at outlet 5.18" (13.2cm) spout reach (c-c)	\$689	\$862	\$1000	\$1034
6-028		Universal Traditional Air Gap, Reverse Osmosis	\$235	\$294	\$341	\$353
1030-5623		Cold Water Dispenser 6.57" (16.7cm) spout height at outlet 4.8" (12.2cm) spout reach (c-c)	\$750	\$938	\$1088	\$1125
6-028		Universal Traditional Air Gap, Reverse Osmosis	\$235	\$294	\$341	\$353
1030-5503		Pot Filler - Wall Mount 4.57" (11.6cm) spout downward offset from the wall inlet center 21.19" (53.8cm) pivoting spout reach from inlet valve (c-c) 3.51" (8.9cm) pivoting inlet valve offset (wall-center) Two shut off valves. Twin knuckles	\$1591	\$1989	\$2307	\$2387
9481		Pot Filler - Wall Mount 4.57" (11.6cm) spout height from wall inlet center 21.19" (53.8cm) pivoting spout reach from inlet valve (c-c) 3.51" (8.9cm) pivoting inlet valve offset (wall-center) Two shut off valves. Twin knuckles We recommend shutting off at marked location (OFF) when not in use	\$1334	\$1668	\$1944	\$2001
1030-5711		Air Gap Kit IAPMO UPC® listed	\$185	\$232	\$269	\$278
2470-5811		Soft Touch Air Activated Disposer Switch Plugs into a standard 120VAC wall outlet	\$382	\$478	\$554	\$573
1030-5721		Soap/Lotion Dispenser Requires 1-1/4" to 1-11/16" through hole Accommodates 2-3/8" maximum deck thickness	\$389	\$487	\$565	\$584
20-373		Soap/Lotion Replacement Head	\$216	\$270	\$313	\$324
125-8		Soap/Lotion Pump	\$67	—	—	—
125-9		Soap/Lotion - Replacement Bottle	\$6	—	—	—
127		Soap/Lotion Dispenser Requires 1-1/4" to 1-11/16" through hole Accommodates 2-1/4" maximum deck thickness	\$352	\$440	\$511	\$528
30-15		Soap/Lotion Replacement Head with Pump	\$184	\$229	\$266	\$275
RP51082		Soap/Lotion Pump	\$33	—	—	—
125-16		Soap/Lotion - Replacement Bottle (16oz)	\$6	—	—	—



Chesterfield Kitchen Bridge Faucet with Side Spray in Uncoated Polished Brass – Living 03N (see page 24)

EAST LINEAR



EAST LINEAR

			I	II	III	IV
1500-5103		<p>Pull-Down Kitchen Faucet Large Spray Head 9.15" (23.2cm) spout height at outlet 8.58" (21.8cm) spout reach (c-c) 16.28" overall height 1.8 gallons (6.8 liters) per minute maximum flow rate.</p>	\$1536	\$1920	\$2228	\$2304
1500-5113		<p>Pull-Down Kitchen Faucet Small Spray Head 9.60" (24.4cm) spout height at outlet 8.52" (21.6cm) spout reach (c-c) 16.28" overall height 1.8 gallons (6.8 liters) per minute maximum flow rate</p>	\$1536	\$1920	\$2228	\$2304
1500-5123		<p>Pull-Down Kitchen Faucet 2-hole install, separate single handle 10.43" (26.5cm) spout height at outlet 9.25" (23.5cm) spout reach (c-c) 16.59" overall height 1.8 gallons (6.8 liters) per minute maximum flow rate</p>	\$1536	\$1920	\$2228	\$2304
1500-5143		<p>Pull-Down Kitchen Faucet Slim body 10.06" (25.5cm) spout height at outlet 8.52" (21.6cm) spout reach (c-c) 16.74" overall height 1.8 gallons (6.8 liters) per minute maximum flow rate</p>	\$1536	\$1920	\$2228	\$2304
1400-5113		<p>Pull-Down Kitchen Faucet 10.36" (26.3cm) spout height at outlet 8.27" (21 cm) spout reach (c-c) 15.91" overall height 1.8 gallons (6.8 liters) per minute maximum flow rate</p>	\$1536	\$1920	\$2228	\$2304
1400-5143		<p>Pull-Down Kitchen Faucet 11.10" (28.2cm) spout height at outlet 8.27" (21 cm) spout reach (c-c) 16.65" overall height 1.8 gallons (6.8 liters) per minute maximum flow rate</p>	\$1536	\$1920	\$2228	\$2304
1500-5173		<p>Pull-Down Kitchen Faucet Trigger Spray. Slim body. 9.37" (23.8cm) spout height at outlet 8.78" (22.3cm) spout reach (c-c) 17.78" overall height 1.8 gallons (6.8 liters) per minute maximum flow rate</p>	\$1788	\$2235	\$2593	\$2682

EAST LINEAR

		I	II	III	IV	
1500-7173		Pull-Down Kitchen Faucet Trigger Spray Extended Reach 11.88" (30.2cm) spout height at outlet 11.19" (28.4 cm) spout reach (c-c) 19.87" overall height 1.8 gallons (6.8 liters) per minute maximum flow rate	\$2165	\$2707	\$3140	\$3356
990IL		Kitchen Faucet Lever Handles. Swivel spout 5.70" (14.5cm) spout height at outlet 7.88" (20.0cm) spout reach (c-c) For 8" (20.3cm) centers - maximum 20" (50.8cm) 1.8 gallons (6.8 liters) per minute maximum flow rate	\$1581	\$1977	\$2293	\$2372
990I		Kitchen Faucet Cross Handles. Swivel spout 5.70" (14.5cm) spout height at outlet 7.88" (20.0cm) spout reach (c-c) For 8" (20.3cm) centers - maximum 20" (50.8cm) 1.8 gallons (6.8 liters) per minute maximum flow rate	\$1581	\$1977	\$2293	\$2372
991IL		Kitchen Faucet with Side Spray Lever Handles. Swivel spout. 5.70" (14.5cm) spout height at outlet 7.88" (20.0cm) spout reach (c-c) For 8" (20.3cm) centers - maximum 20" (50.8cm) 1.8 gallons (6.8 liters) per minute maximum flow rate	\$1913	\$2392	\$2815	\$2870
991I		Kitchen Faucet with Side Spray Cross Handles. Swivel spout 5.70" (14.5cm) spout height at outlet 7.88" (20.0cm) spout reach (c-c) For 8" (20.3cm) centers - maximum 20" (50.8cm) 1.8 gallons (6.8 liters) per minute maximum flow rate	\$1913	\$2392	\$2815	\$2870
1500-5403		Kitchen Bridge Faucet Lever Handles 8.32" (21.1 cm) spout height at outlet 9.30" (23.6cm) spout reach (c-c) For 8" (20.3cm) centers 1.8 gallons (6.8 liters) per minute maximum flow rate	\$1878	\$2348	\$2724	\$2817
1500-5463		Kitchen Bridge Pull-Down Faucet Lever Handles 10.01" (25.4cm) spout height at outlet 8.52" (21.6cm) spout reach (c-c) For 8" (20.3cm) centers 1.8 gallons (6.8 liters) per minute maximum flow rate	\$2042	\$2553	\$2961	\$3063

EAST LINEAR

		I	II	III	IV	
1400-5463		Kitchen Bridge Pull-Down Faucet Lever Handles 8.78" (22.3cm) spout height at outlet 8.27" (21.0cm) spout reach (c-c) For 8" (20.3cm) centers 1.8 gallons (6.8 liters) per minute maximum flow rate	\$2042	\$2553	\$2961	\$3063
1400-5403		Kitchen Bridge Faucet, Lever Handles 11.21" (21.2cm) spout height at outlet 9" (22.8cm) spout reach (c-c) For 8" (20.3cm) centers 1.8 gallons (6.8 liters) per minute maximum flow rate	\$1878	\$2348	\$2724	\$2817
1500-5402		Kitchen Bridge Faucet Cross Handles 8.32" (21.1cm) spout height at outlet 9.30" (23.6cm) spout reach (c-c) For 8" (20.3cm) centers 1.8 gallons (6.8 liters) per minute maximum flow rate	\$1878	\$2348	\$2724	\$2817
1400-5402		Kitchen Bridge Faucet, Cross Handles 11.21" (21.2cm) spout height at outlet 9" (22.8cm) spout reach (c-c) For 8" (20.3cm) centers 1.8 gallons (6.8 liters) per minute maximum flow rate	\$1878	\$2348	\$2724	\$2817
1500-5462		Kitchen Bridge Pull-Down Faucet Cross Handles 10.01" (25.4cm) spout height at outlet 8.52" (21.6cm) spout reach (c-c) For 8" (20.3cm) centers 1.8 gallons (6.8 liters) per minute maximum flow rate	\$2042	\$2553	\$2961	\$3063
1400-5462		Kitchen Bridge Pull-Down Faucet Cross Handles 8.78" (22.3cm) spout height at outlet 8.27" (21.0cm) spout reach (c-c) For 8" (20.3cm) centers 1.8 gallons (6.8 liters) per minute maximum flow rate	\$2042	\$2553	\$2961	\$3063
1500-5413		Kitchen Bridge Faucet w/Side Spray Lever Handles 8.32" (21.1cm) spout height at outlet 9.30" (23.6cm) spout reach (c-c) For 8" (20.3cm) centers 1.8 gallons (6.8 liters) per minute maximum flow rate	\$2454	\$3178	\$3711	\$3820

KITCHEN

EAST LINEAR

		I	II	III	IV	
1400-5413		Kitchen Bridge Faucet with Side Spray Lever Handle 11.21" (21.2cm) spout height at outlet 9" (22.8cm) spout reach (c-c) For 8" (20.3cm) centers 1.8 gallons (6.8 liters) per minute maximum flow rate	\$2454	\$3178	\$3711	\$3897
1500-5412		Kitchen Bridge Faucet w/Side Spray Cross Handles 8.32" (21.1cm) spout height at outlet 9.30" (23.6cm) spout reach (c-c) For 8" (20.3cm) centers 1.8 gallons (6.8 liters) per minute maximum flow rate	\$2454	\$3178	\$3711	\$3820
1400-5412		Kitchen Bridge Faucet with Side Spray Cross Handles 11.21" (21.2cm) spout height at outlet 9" (22.8cm) spout reach (c-c) For 8" (20.3cm) centers 1.8 gallons (6.8 liters) per minute maximum flow rate	\$2394	\$3178	\$3711	\$3897
2008		Prep/Bar Faucet 7.42" (18.8cm) spout height at outlet 7.13" (18.1cm) spout reach (c-c) 12.98" overall height 1.8 gallons (6.8 liters) per minute maximum flow rate	\$1235	\$1544	\$1791	\$1853
1500-5233		Prep/Bar Faucet 7.79" (19.8cm) spout height at outlet 7.13" (18.1cm) spout reach (c-c) 13.35" overall height 1.8 gallons (6.8 liters) per minute maximum flow rate	\$1235	\$1544	\$1791	\$1853
1500-5203		Prep/Bar Pull Down Faucet 7.01" (17.8cm) spout height at outlet 7.47" (19.0cm) spout reach (c-c) 13.66" overall height 1.8 gallons (6.8 liters) per minute maximum flow rate	\$1536	\$1920	\$2228	\$2304
1500-5223		Prep/Bar Pull-Down Faucet 7.46" (18.9cm) spout height at outlet 7.41" (18.8cm) spout reach (c-c) 13.67" overall height 1.8 gallons (6.8 liters) per minute maximum flow rate	\$1536	\$1920	\$2228	\$2304

EAST LINEAR

			I	II	III	IV
2007		Prep/Bar Faucet 7.41" (18.8cm) spout height at outlet 6.13" (15.6cm) spout reach (c-c) 10.91" overall height 1.8 gallons (6.8 liters) per minute maximum flow rate	\$1210	\$1513	\$1755	\$1815
106		Hot and Cold Water Dispenser 6.28" (16cm) spout height at outlet 4" (10.2cm) spout reach (c-c) HOT WATER TANK #5-036 SOLD SEPARATELY	\$938	\$1173	\$1361	\$1407
106H		Hot Water Dispenser 6.28" (16cm) spout height at outlet 4" (10.2cm) spout reach (c-c) HOT WATER TANK #5-036 SOLD SEPARATELY	\$845	\$1057	\$1226	\$1268
106C		Cold Water Dispenser 6.28" (16cm) spout height at outlet 4" (10.2cm) spout reach (c-c)	\$680	\$850	\$986	\$1020
6-027		Universal Contemporary Air Gap, Reverse Osmosis	\$246	\$308	\$357	\$369
9485		Pot Filler - Wall Mount 4.37" (11.1cm) spout height from wall inlet center 21.39" (54.3cm) pivoting spout reach from inlet valve (c-c) 3.54" (9.0cm) pivoting inlet valve offset (wall-center) Two shut off valves. Twin knuckles We recommend shutting off at marked location (OFF) when not in use Matches East Linear Series	\$1334	\$1668	\$1944	\$2001
100		Air Gap Kit IAPMO UPC® listed	\$98	\$123	\$143	\$147
1500-5811		Soft Touch Air Activated Disposer Switch Plugs into a standard 120VAC wall outlet	\$391	\$489	\$567	\$587
1500-5721		Soap/Lotion Dispenser Requires 1-1/4" to 1-11/16" through hole Accommodates 2-3/8" maximum deck thickness	\$398	\$498	\$578	\$597
20-373		Soap/Lotion Replacement Head	\$216	\$270	\$313	\$324
125-8		Soap/Lotion Pump	\$67	—	—	—
125-9		Soap/Lotion - Replacement Bottle	\$6	—	—	—



GAVIN



GAVIN

		I	II	III	IV	
3210-5103		Pull-Down Kitchen Faucet 10.37" (26.4cm) spout height at outlet 8.58" (21.8cm) spout reach (c-c) 17.49" overall height 1.8 gallons (6.8 liters) per minute maximum flow rate	\$1516	\$1895	\$2199	\$2274
3210-5203		Prep/Bar Pull-Down Faucet 8.24" (20.9cm) spout height at outlet 7.47" (19.0 cm) spout reach (c-c) 14.89" overall height 1.8 gallons (6.8 liters) per minute maximum flow rate	\$1516	\$1895	\$2199	\$2274
3210-5603		Hot and Cold Water Dispenser 6.73" (17cm) spout height at outlet 4.74" (12.0 cm) spout reach (c-c) HOT WATER TANK #5-036 SOLD SEPARATELY	\$1156	\$1445	\$1677	\$1734
3210-5613		Hot Water Dispenser 6.73" (17cm) spout height at outlet 4.74" (12.0cm) spout reach (c-c) HOT WATER TANK #5-036 SOLD SEPARATELY	\$883	\$1104	\$1281	\$1325
3210-5623		Cold Water Dispenser 6.73" (17cm) spout height at outlet 4.74" (12.0cm) spout reach (c-c)	\$750	\$938	\$1088	\$1125
6-028		Universal Traditional Air Gap, Reverse Osmosis	\$235	\$294	\$341	\$353
3210-5503		Pot Filler - Wall Mount 4.37" (11.1cm) spout downward offset from wall inlet center 21.39" (54.3cm) pivoting spout reach from inlet valve (c-c) 3.51" (8.9cm) pivoting inlet valve offset (wall-center) Two shut off valves. Twin knuckles.	\$1591	\$1989	\$2307	\$2387
3180-5711		Air Gap Kit	\$194	\$243	\$282	\$291

GAVIN

			I	II	III	IV
3210-5811		Soft Touch Air Activated Disposer Switch Plugs into a standard 120VAC wall outlet	\$382	\$478	\$554	\$573
3210-5721		Soap/Lotion Dispenser Requires 1-1/4" to 1-11/16" through hole Accommodates 2-3/8" maximum deck thickness	\$398	\$498	\$578	\$597
RP20-374		Soap/Lotion Replacement Head	\$216	\$270	\$313	\$324
125-8		Soap/Lotion Pump	\$67	—	—	—
125-9		Soap/Lotion - Replacement Bottle	\$6	—	—	—



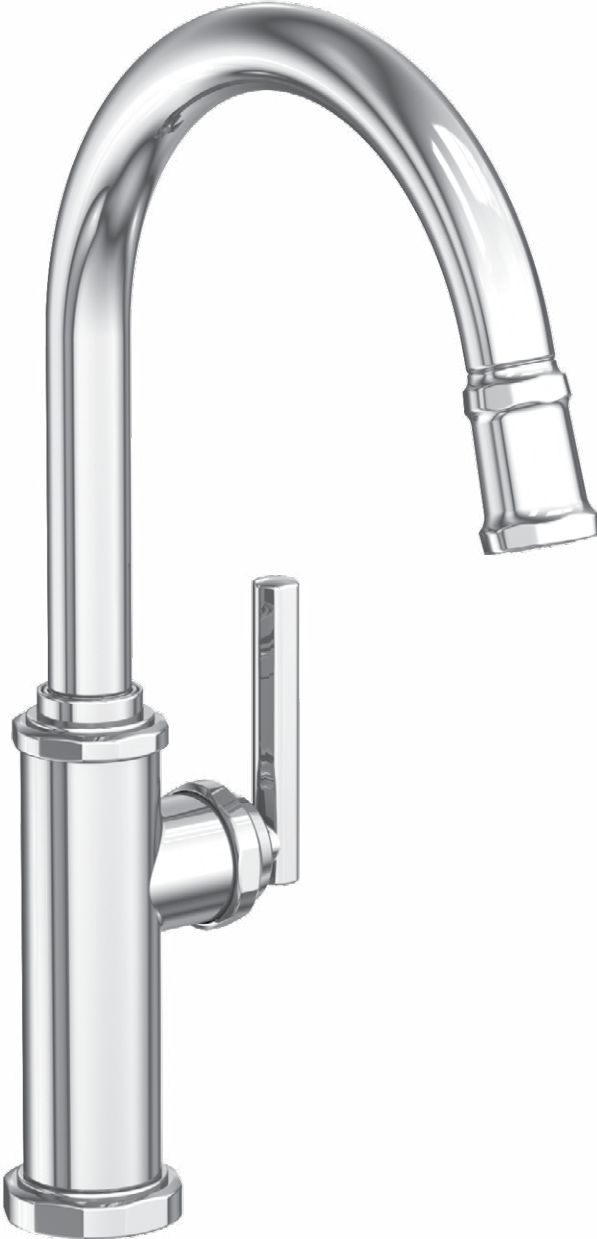

Chesterfield Extended Reach Pull-Down Faucet in Satin Bronze (10) (see pg. 24)



HEANEY

			I	II	III	IV
3190-5113		Pull-Down Kitchen Faucet 10.76" (27.3cm) spout height at outlet 8.52" (21.6cm) spout reach (c-c) 17.45" overall height 1.8 gallons (6.8 liters) per minute maximum flow rate	\$1480	\$1850	\$2146	\$2220
3190-5146		Pull-Down Kitchen Faucet Paddle Handle 10.52" (26.7cm) spout height at outlet 8.54" (21.7cm) spout reach (c-c) 17.36" overall height 1.8 gallons (6.8 liters) per minute maximum flow rate	\$1480	\$1850	\$2146	\$2220
3190-5223		Prep/Bar Pull-Down Faucet 8.65" (22.0cm) spout height at outlet 7.40" (18.8cm) spout reach (c-c) 14.85" overall height 1.8 gallons (6.8 liters) per minute maximum flow rate	\$1480	\$1850	\$2146	\$2220
3190-5246		Prep/Bar Pull-Down Faucet Paddle Handle 8.34" (21.2 cm) spout height at outlet 7.43" (18.9 cm) spout reach (c-c) For single hole configurations 1.8 gallons (6.8 liters) per minute maximum flow rate	\$1480	\$1850	\$2146	\$2220
3190-5603		Hot and Cold Water Dispenser 6.35" (16.1 cm) spout height at outlet 4" (10.2cm) spout reach (c-c) HOT WATER TANK #5-036 SOLD SEPARATELY	\$1134	\$1418	\$1645	\$1701
3190-5613		Hot Water Dispenser 6.35" (16.1 cm) spout height at outlet 4" (10.2cm) spout reach (c-c) WATER TANK #5-036 SOLD SEPARATELY.	\$883	\$1104	\$1281	\$1325
3190-5623		Cold Water Dispenser 6.35" (16.1 cm) spout height at outlet 4" (10.2cm) spout reach (c-c)	\$750	\$938	\$1088	\$1125
6-027		Universal Contemporary Air Gap, Reverse Osmosis	\$246	\$308	\$357	\$369

HEANEY

		I	II	III	IV
3190-5503	 <p>Pot Filler - Wall Mount 4.37" (11.1cm) spout downward offset from the wall inlet center 21.39" (54.3cm) pivoting spout reach from inlet valve (c-c) 3.51" (8.9cm) pivoting inlet valve offset (wall-center) Two shut off valves. Twin knuckles.</p>	\$1591	\$1989	\$2307	\$2387
3180-5711	 <p>Air Gap Kit IAPMO UPC® listed</p>	\$194	\$243	\$282	\$291
3190-5811	 <p>Soft Touch Air Activated Disposer Switch Plugs into a standard 120VAC wall outlet</p>	\$382	\$478	\$554	\$573
3190-5721	 <p>Soap/Lotion Dispenser Requires 1-1/4" to 1-11/16" through hole Accommodates 2-3/8" maximum deck thickness</p>	\$398	\$498	\$578	\$597
20-373	Soap/Lotion Replacement Head	\$216	\$270	\$313	\$324
125-8	Soap/Lotion Pump	\$67	—	—	—
125-9	Soap/Lotion - Replacement Bottle	\$6	—	—	—







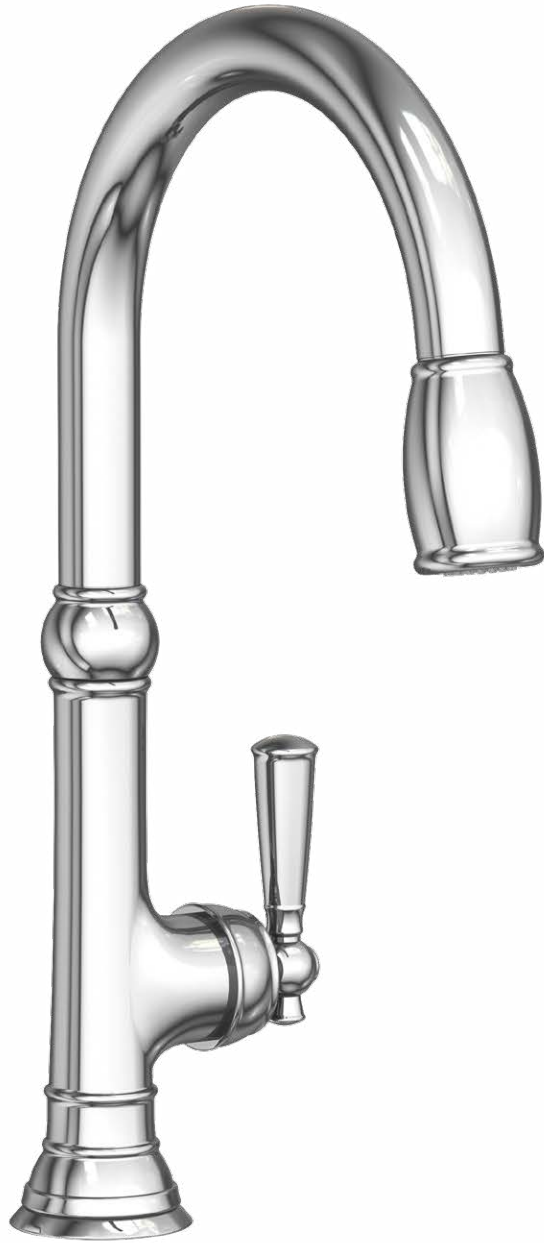



NEW Heaney Kitchen Pull-Down Faucet in Oil Rubbed Bronze (10B) (see page 42)

JACOBEBAN

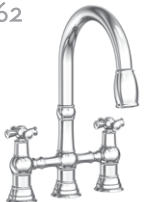

JACOBEBAN

			I	II	III	IV
2470-5103		Pull-Down Kitchen Faucet 9.81" (24.9cm) spout height at outlet 8.58" (21.8cm) spout reach (c-c) 16.93" overall height 1.8 gallons (6.8 liters) per minute maximum flow rate	\$1569	\$1962	\$2276	\$2354
2470-5183		Pull-Down Kitchen Faucet Trigger Spray 10.03" (25.4cm) spout height at outlet 8.78" (22.3cm) spout reach (c-c) 18.43" overall height 1.8 gallons (6.8 liters) per minute maximum flow rate	\$1826	\$2283	\$2648	\$2739
2470-7183		Pull-Down Kitchen Faucet Trigger Spray. Extended Reach 12.05" (30.6 cm) spout height at outlet 11.19" (28.4 cm) spout reach (c-c) 20.05" overall height 1.8 gallons (6.8 liters) per minute maximum flow rate	\$2165	\$2707	\$3140	\$3356
2470-5303		Single Handle Kitchen Faucet 7.67" (19.5cm) spout height at outlet 9.05" (23.0cm) spout reach (c-c) 10.88" overall height 1.8 gallons (6.8 liters) per minute maximum flow rate	\$1269	\$1587	\$1841	\$1904
2470-5313		Single Handle Kitchen Faucet with Side Spray 7.67" (19.5cm) spout height at outlet 9.05" (23.0cm) spout reach (c-c) 10.88" overall height 1.8 gallons (6.8 liters) per minute maximum flow rate	\$1634	\$2043	\$2370	\$2451
2470-5463		Kitchen Pull-Down Faucet. Lever Handles 8.14" (20.7cm) spout height at outlet 8.58" (21.8cm) spout reach (c-c) For 8" (20.3cm) centers 1.8 gallons (6.8 liters) per minute maximum flow rate	\$1878	\$2348	\$2724	\$2817
2470-5462		Kitchen Pull-Down Faucet. Cross Handles 8.14" (20.7cm) spout height at outlet 8.58" (21.8cm) spout reach (c-c) For 8" (20.3cm) centers 1.8 gallons (6.8 liters) per minute maximum flow rate	\$1878	\$2348	\$2724	\$2817
2470-5433		Kitchen Faucet with Side Spray. Lever Handles 6" (15.2cm) spout height at outlet 9.05" (23.0cm) spout reach (c-c) For 8" (20.3cm) centers - maximum 20" (50.8cm) 1.8 gallons (6.8 liters) per minute maximum flow rate	\$1787	\$2234	\$2592	\$2681

NEW

JACOBEBAN

		I	II	III	IV	
2470-5432		<p>Kitchen Faucet with Side Spray, Cross Handles 6" (15.2cm) spout height at outlet 9.05" (23.0cm) spout reach (c-c) For 8" (20.3cm) centers - maximum 20" (50.8cm) 1.8 gallons (6.8 liters) per minute maximum flow rate</p>	\$1787	\$2234	\$2592	\$2681
2470-5233		<p>Prep/Bar Faucet 7.96" (20.2cm) spout height at outlet 7.00" (17.8cm) spout reach (c-c) 13.48" overall height 1.8 gallons (6.8 liters) per minute maximum flow rate</p>	\$1235	\$1544	\$1791	\$1853
2470-5203		<p>Prep/Bar Faucet 7.73" (19.7cm) spout height at outlet 6.70" (17.0cm) spout reach (c-c) 9.99" overall height 1.8 gallons (6.8 liters) per minute maximum flow rate</p>	\$1264	\$1580	\$1833	\$1896
2470-5223		<p>Prep/Bar Pull Down Faucet 8.80" (22.4cm) spout height at outlet 6.55" (16.6cm) spout reach (c-c) 14.84" overall height 1.8 gallons (6.8 liters) per minute maximum flow rate</p>	\$1500	\$1875	\$2175	\$2250
2470-5503		<p>Pot Filler - Wall Mount 4.57" (11.6cm) spout downward offset from the wall inlet center 21.19" (53.8cm) pivoting spout reach from inlet valve (c-c) 3.51" (8.9cm) pivoting inlet valve offset (wall-center) Two shut off valves. Twin knuckles.</p>	\$1485	\$1857	\$2154	\$2228
2470-5603		<p>Hot and Cold Water Dispenser 6.73" (17.0cm) spout height at outlet 4.74" (12.0cm) spout reach (c-c) HOT WATER TANK #5-036 SOLD SEPARATELY</p>	\$1118	\$1398	\$1622	\$1677
2470-5613		<p>Hot Water Dispenser 6.73" (17.0cm) spout height at outlet 4.74" (12.0cm) spout reach (c-c) HOT WATER TANK #5-036 SOLD SEPARATELY</p>	\$849	\$1062	\$1232	\$1274

JACOBEBAN

			I	II	III	IV
2470-5623		Cold Water Dispenser 6.73" (17.0cm) spout height at outlet 4.74" (12.0cm) spout reach (c-c)	\$681	\$852	\$988	\$1022
6-028		Universal Traditional Air Gap, Reverse Osmosis	\$235	\$294	\$341	\$353
2470-5711		Air Gap Kit IAPMO UPC® listed	\$258	\$323	\$375	\$387
2470-5811		Soft Touch Air Activated Disposer Switch Plugs into a standard 120VAC wall outlet	\$382	\$478	\$554	\$573
2470-5721		Soap/Lotion Dispenser Requires 1-1/4" to 1-11/16" through hole Accommodates 2-7/16" maximum deck thickness	\$398	\$498	\$578	\$597
RP20-374		Soap/Lotion Replacement Head	\$216	\$270	\$313	\$324
125-8		Soap/Lotion Pump	\$67	—	—	—
125-9		Soap/Lotion - Replacement Bottle	\$6	—	—	—

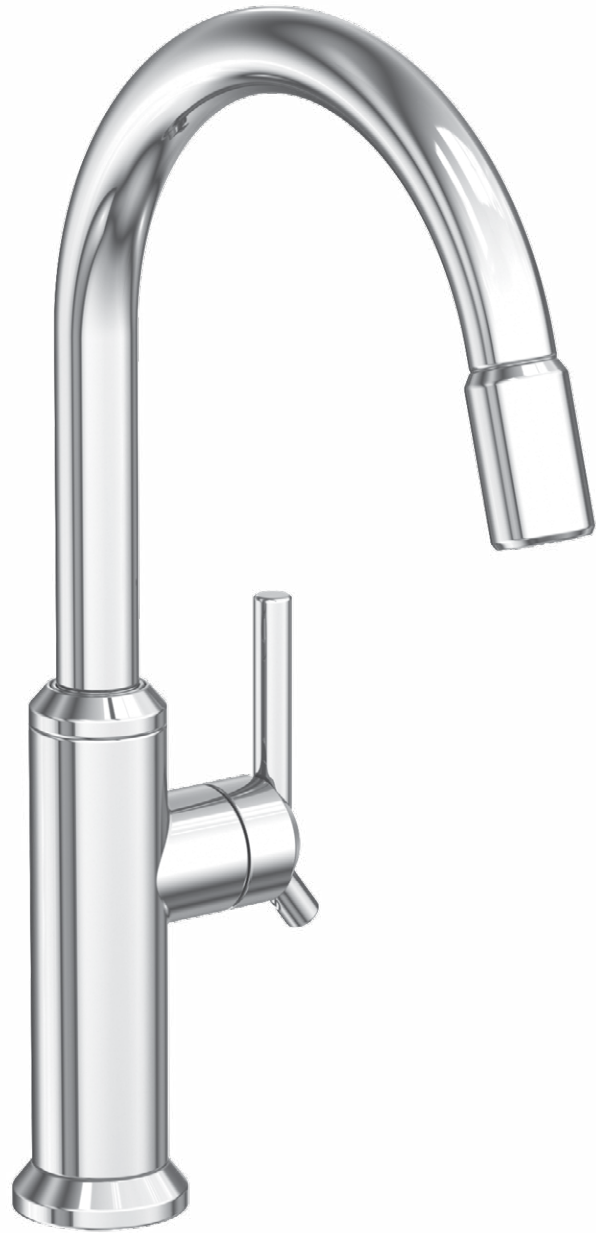

JETER



JETER

		I	II	III	IV	
3200-5113		Pull-Down Kitchen Faucet 10.77" (27.4cm) spout height at outlet 8.52" (21.6cm) spout reach (c-c) 17.45" overall height 1.8 gallons (6.8 liters) per minute maximum flow rate	\$1768	\$2210	\$2564	\$2652
3200-5223		Prep/Bar Pull-Down Faucet 8.65" (22.0cm) spout height at outlet 7.40" (18.8cm) spout reach (c-c) 14.85" overall height 1.8 gallons (6.8 liters) per minute maximum flow rate	\$1768	\$2210	\$2564	\$2652
3200-5503		Pot Filler - Wall Mount 4.37" (11.1cm) spout downward offset from wall inlet center 21.39" (54.3cm) pivoting spout reach from inlet valve (c-c) 3.51" (8.9cm) pivoting inlet valve offset (wall-center) Two shut off valves. Twin knuckles.	\$1591	\$1989	\$2307	\$2387
3200-5603		Hot and Cold Water Dispenser 6.35" (16.1cm) spout height at outlet 4" (10.2cm) spout reach (c-c) HOT WATER TANK #5-036 SOLD SEPARATELY	\$1156	\$1445	\$1677	\$1734
3200-5613		Hot Water Dispenser 6.35" (16.1cm) spout height at outlet 4" (10.2cm) spout reach (c-c) HOT WATER TANK #5-036 SOLD SEPARATELY	\$883	\$1104	\$1281	\$1325
3200-5623		Cold Water Dispenser 6.35" (16.1cm) spout height at outlet 4" (10.2cm) spout reach (c-c)	\$735	\$919	\$1066	\$1103
6-027		Universal Contemporary Air Gap, Reverse Osmosis	\$246	\$308	\$357	\$369
3180-5711		Air Gap Kit IAPMO UPC® listed	\$194	\$243	\$282	\$291

JETER

		I	II	III	IV
3200-5811	 <p>Pull-Down Kitchen Faucet Large Spray Head 9.15" (23.2cm) spout height at outlet 8.58a" (21.8cm) spout reach (c-c) 16.28" overall height 1.8 gallons (6.8 liters) per minute maximum flow rate</p>	\$374	\$468	\$543	\$561
3200-5721	 <p>Soap/Lotion Dispenser Requires 1-1/4" to 1-1/16" through hole Accommodates 2-3/8" maximum deck thickness</p>	\$398	\$498	\$578	\$597
20-373	 <p>Soap/Lotion Replacement Head</p>	\$216	\$270	\$313	\$324
125-8	Soap/Lotion Pump	\$67	—	—	—
125-9	Soap/Lotion - Replacement Bottle	\$6	—	—	—



Jeter Kitchen Pull-Down Faucet in Stainless Steel PVD (20) (see page 50)

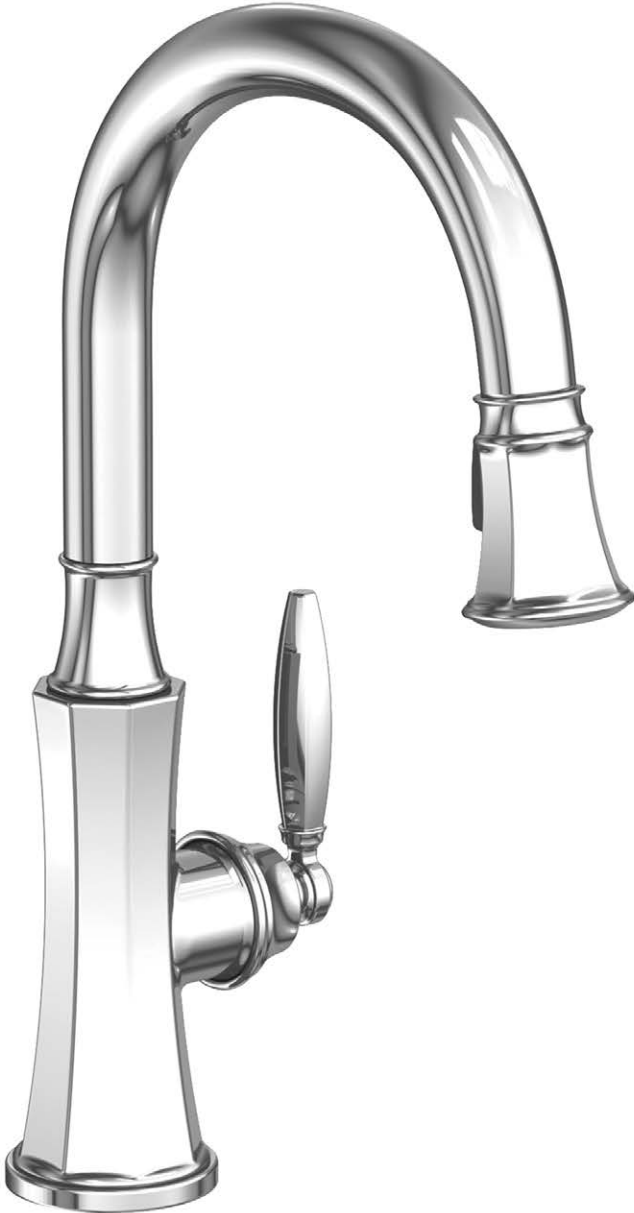

METROPOLE



METROPOLE

			I	II	III	IV
1200-5103		<p>Pull-Down Faucet 9.06" (23.0 cm) spout height at outlet 8.53" (21.7 cm) spout reach (c-c) 16.28" overall height 1.8 gallons per minute maximum flow rate</p>	\$1643	\$2054	\$2383	\$2465
1200-5223		<p>Prep/Bar Pull-Down Faucet 8.17" (20.8 cm) spout height at outlet 6.55" (16.6 cm) spout reach (c-c) 14.21" overall height 1.8 gallons per minute maximum flow rate</p>	\$1643	\$2054	\$2383	\$2465
1200-5503		<p>Pot Filler - Wall Mount 4.57" (11.6 cm) spout downward offset from the wall inlet center 21.19" (53.8 cm) pivoting spout reach from inlet valve (c-c) 3.51" (8.9 cm) pivoting inlet valve offset (wall-center) Two shut off valves. Twin knuckles.</p>	\$1591	\$1989	\$2307	\$2387
1200-5603		<p>Hot and Cold Water Dispenser 7.36" (18.7cm) spout height at outlet 4.74" (12.0cm) spout reach (c-c)</p> <p>HOT WATER TANK #5-036 SOLD SEPARATELY</p>	\$1122	\$1403	\$1627	\$1683
1200-5613		<p>Hot Water Dispenser 7.36" (18.7 cm) spout height at outlet 4.74" (12.0cm) spout reach (c-c)</p> <p>HOT WATER TANK #5-036 SOLD SEPARATELY</p>	\$883	\$1104	\$1281	\$1325
1200-5623		<p>Cold Water Dispenser 7.36" (18.7 cm) spout height at outlet 4.74" (12.0cm) spout reach (c-c).</p>	\$735	\$919	\$1066	\$1103
6-027		Contemporary Air Gap, Reverse Osmosis	\$246	\$308	\$357	\$369
3180-5711		Air Gap Kit IAPMO UPC® listed	\$194	\$243	\$282	\$291

METROPOLE

			I	II	III	IV
3190-5811		Soft Touch Air Activated Disposer Switch Plugs into a standard 120 VAC wall outlet	\$382	\$478	\$554	\$573
2500-5721		Soap/Lotion Dispenser Requires 1-1/4" to 1-11/16" through hole Accommodates 2-1/4" maximum deck thickness	\$389	\$487	\$565	\$584
20-405		Soap/Lotion Replacement Head	\$216	\$270	\$313	\$324
125-8		Soap/Lotion Pump	\$67	—	—	—
125-9		Soap/Lotion - Replacement Bottle	\$6	—	—	—



Muncy Kitchen Collection in Satin Nickel (15S) (see page 58)

MUNCY



MUNCY

			I	II	III	IV
3290-5113		Pull-Down Kitchen Faucet 9.59" (24.4cm) spout height at outlet 8.52" (21.6cm) spout reach (c-c) 16.28" overall height 1.8 gallons (6.8 liters) per minute maximum flow rate	\$1783	\$2229	\$2586	\$2675
3290-5143		Pull-Down Kitchen Faucet 10.2" (25.9cm) spout height at outlet 8.52" (21.6cm) spout reach (c-c) 16.89" overall height 1.8 gallons (6.8 liters) per minute maximum flow rate	\$1783	\$2229	\$2586	\$2675
3360-5113		Pull-Down Kitchen Faucet 10.61" (27.0cm) spout height at outlet 8.27" (21.0cm) spout reach (c-c) 16.16" overall height 1.8 gallons (6.8 liters) per minute maximum flow rate	\$1783	\$2229	\$2586	\$2675
3290-5173		Pull-Down Kitchen Faucet Trigger Spray. Slim body 9.37" (23.8cm) spout height at outlet 8.78" (22.3cm) spout reach (c-c) 17.78" overall height 1.8 gallons (6.8 liters) per minute maximum flow rate	\$2016	\$2520	\$2924	\$3024
3290-7173		Pull-Down Kitchen Faucet Trigger Spray. Extended Reach 12.00" (30.5 cm) spout height at outlet 11.19" (28.4 cm) spout reach (c-c) 20.00" overall height 1.8 gallons (6.8 liters) per minute maximum flow rate	\$2165	\$2707	\$3140	\$3024
						
3290-5463		Kitchen Bridge Pull-Down Faucet Lever Handles 10.01" (25.4cm) spout height at outlet 8.52" (21.6cm) spout reach (c-c) For 8" (20.3cm) centers 1.8 gallons (6.8 liters) per minute maximum flow rate	\$2083	\$2604	\$3021	\$3125
3290-5413		Kitchen Bridge Faucet with Side Spray Lever Handles 8.50" (21.6cm) spout height at outlet 9" (22.9cm) spout reach (c-c) For 8" (20.3cm) centers 1.8 gallons (6.8 liters) per minute maximum flow rate	\$2950	\$3688	\$4278	\$4425

MUNCY

		I	II	III	IV
3360-5413	 <p>Kitchen Bridge Faucet with Side Spray Lever Handles 11.24" (28.5cm) spout height at outlet 9" (22.9cm) spout reach (c-c) For 8" (20.3cm) centers 1.8 gallons (6.8 liters) per minute maximum flow rate</p>	\$2950	\$3688	\$4278	\$4425
3290-5233	 <p>Prep/Bar Faucet 7.92" (20.1cm) spout height at outlet 7.00" (17.7cm) spout reach (c-c) 13.48" overall height 1.8 gallons (6.8 liters) per minute maximum flow rate</p>	\$1415	\$1769	\$2052	\$2123
3290-5223	 <p>Prep/Bar Pull-Down Faucet 7.46" (18.9cm) spout height at outlet 7.41" (18.8cm) spout reach (c-c) 13.67" overall height 1.8 gallons (6.8 liters) per minute maximum flow rate</p>	\$1745	\$2182	\$2531	\$2618
3290-5503	 <p>Pot Filler - Wall Mount 4.35" (11.0cm) spout downward offset from wall inlet center 21.39" (54.3cm) pivoting spout reach from inlet valve (c-c) 3.51" (8.9cm) pivoting inlet valve offset (wall-center) Two shut off valves. Twin knuckles.</p>	\$1591	\$1989	\$2307	\$2387
3290-5603	 <p>Hot and Cold Water Dispenser 6.35" (16.1cm) spout height at outlet 4" (10.2cm) spout reach (c-c) HOT WATER TANK #5-036 SOLD SEPARATELY</p>	\$1156	\$1445	\$1677	\$1734
3290-5613	 <p>Hot Water Dispenser 6.35" (16.1cm) spout height at outlet 4" (10.2cm) spout reach (c-c) WATER TANK #5-036 SOLD SEPARATELY</p>	\$883	\$1104	\$1281	\$1325
3290-5623	 <p>Cold Water Dispenser 6.35" (16.1cm) spout height at outlet 4" (10.2cm) spout reach (c-c)</p>	\$735	\$919	\$1066	\$1103
6-027	 <p>Universal Contemporary Air Gap, Reverse Osmosis</p>	\$246	\$308	\$357	\$369

MUNCY

			I	II	III	IV
3180-5711		Air Gap Kit IAPMO UPC® listed	\$194	\$243	\$282	\$291
3290-5811		Soft Touch Air Activated Disposer Switch Plugs into a standard 120VAC wall outlet	\$382	\$478	\$554	\$573
3180-5721		Soap/Lotion Dispenser Requires 1-1/4" to 1-11/16" through hole Accommodates 2-3/8" maximum deck thickness	\$398	\$498	\$578	\$597
20-373		Soap/Lotion Replacement Head	\$216	\$270	\$313	\$324
125-8		Soap/Lotion Pump	\$67	—	—	—
125-9		Soap/Lotion - Replacement Bottle	\$6	—	—	—

MUNCY
(BLACK x SATIN BRASS-PVD)



MUNCY (BLACK x SATIN BRASS-PVD)

56 x 04

KITCHEN

3290-5113



Pull-Down Kitchen Faucet
 9.59" (24.4cm) spout height at outlet
 8.52" (21.6cm) spout reach (c-c)
 16.28" overall height
 1.8 gallons (6.8 liters) per minute maximum flow rate

\$2229

3290-5143



Pull-Down Kitchen Faucet
 10.2" (25.9cm) spout height at outlet
 8.52" (21.6cm) spout reach (c-c)
 16.89" overall height
 1.8 gallons (6.8 liters) per minute maximum flow rate

\$2229

3360-5113



Pull-Down Kitchen Faucet
 10.61" (27.0cm) spout height at outlet
 8.27" (21.0cm) spout reach (c-c)
 16.16" overall height
 1.8 gallons (6.8 liters) per minute maximum flow rate

\$2229

3290-5173



Pull-Down Kitchen Faucet
 Trigger Spray. Slim body
 9.37" (23.8cm) spout height at outlet
 8.78" (22.3cm) spout reach (c-c)
 17.78" overall height
 1.8 gallons (6.8 liters) per minute maximum flow rate

\$2520

3290-7173



Pull-Down Kitchen Faucet
 Trigger Spray. Extended Reach
 12.00" (30.5 cm) spout height at outlet
 11.19" (28.4 cm) spout reach (c-c)
 20.00" overall height
 1.8 gallons (6.8 liters) per minute maximum flow rate

\$2707

NEW

3290-5463



Kitchen Bridge Pull-Down Faucet
 Lever Handles
 10.01" (25.4cm) spout height at outlet
 8.52" (21.6cm) spout reach (c-c)
 For 8" (20.3cm) centers
 1.8 gallons (6.8 liters) per minute maximum flow rate

\$2604

3290-5413



Kitchen Bridge Faucet with Side Spray
 Lever Handles
 8.50" (21.6cm) spout height at outlet
 9" (22.9cm) spout reach (c-c)
 For 8" (20.3cm) centers
 1.8 gallons (6.8 liters) per minute maximum flow rate

\$3688

MUNCY (BLACK x SATIN BRASS-PVD)

56 x 04

3360-5413



Kitchen Bridge Faucet with Side Spray
Lever Handles
11.24" (28.5cm) spout height at outlet
9" (22.9cm) spout reach (c-c)
For 8" (20.3cm) centers
1.8 gallons (6.8 liters) per minute maximum flow rate

\$3688

3290-5233



Prep/Bar Faucet
7.92" (20.1cm) spout height at outlet
7.00" (17.7cm) spout reach (c-c)
13.48" overall height
1.8 gallons (6.8 liters) per minute maximum flow rate

\$1769

3290-5223



Prep/Bar Pull-Down Faucet
7.46" (18.9cm) spout height at outlet
7.41" (18.8cm) spout reach (c-c)
13.67" overall height
1.8 gallons (6.8 liters) per minute maximum flow rate

\$2182

3290-5503



Pot Filler - Wall Mount
4.35" (11.0cm) spout downward offset from wall inlet center
21.39" (54.3cm) pivoting spout reach from inlet valve (c-c)
3.51" (8.9cm) pivoting inlet valve offset (wall-center)
Two shut off valves. Twin knuckles.

\$1989

3290-5603



Hot and Cold Water Dispenser
6.35" (16.1cm) spout height at outlet
4" (10.2cm) spout reach (c-c)

\$1445

HOT WATER TANK #5-036 SOLD SEPARATELY

3290-5623



Cold Water Dispenser
6.35" (16.1cm) spout height at outlet
4" (10.2cm) spout reach (c-c)

\$919

3290-5613



Hot Water Dispenser
6.35" (16.1cm) spout height at outlet
4" (10.2cm) spout reach (c-c)

\$1104

WATER TANK #5-036 SOLD SEPARATELY

MUNCY (BLACK x SATIN BRASS-PVD)

56 x 04

3180-5711



Air Gap Kit
IAPMO UPC® listed

\$243

3290-5811



Soft Touch Air Activated Disposer Switch
Plugs into a standard 120VAC wall outlet

\$478

3180-5721







Soap/Lotion Dispenser
Requires 1-1/4" to 1-11/16" through hole
Accommodates 2-3/8" maximum deck thickness

\$498

NADYA



NADYA





			I	II	III	IV
2510-5103		Pull-down Kitchen Faucet 11.73" (29.8cm) spout height at outlet 9" (22.9cm) spout reach (c-c) 17.65" overall height 1.8 gallons (6.8 liters) per minute maximum flow rate	\$1373	\$1717	\$1991	\$2060
940		Single Handle Kitchen Faucet 5.63" (14.3cm) spout height at outlet 9.68" (24.6cm) spout reach (c-c) 7.99" overall height 1.8 gallons (6.8 liters) per minute maximum flow rate	\$1393—	\$1717	\$1991	\$2060
941		Single Handle Kitchen Faucet with Side Spray 5.63" (14.3cm) spout height at outlet 9.68" (24.6cm) spout reach (c-c) 7.99" overall height 1.8 gallons (6.8 liters) per minute maximum flow rate	\$1784	\$2230	\$2587	\$2676
2510-5203		Prep/Bar Pull-Down Faucet 6.21" (15.8cm) spout height at outlet 6.55" (16.6cm) spout reach (c-c) 12.25" overall height 1.8 gallons (6.8 liters) per minute maximum flow rate Matches Nadya Collection	\$1260	\$1575	\$1827	\$1890
8081		Prep/Bar Faucet 10" (25.4cm) spout height at outlet 5.27" (13.4cm) spout reach (c-c) For single hole configurations 1.8 gallons (6.8 liters) per minute maximum flow rate	\$1222	\$1528	\$1772	\$1833
107		Hot and Cold Water Dispenser 6.57" (16.7cm) spout height at outlet 4.8" (12.2cm) spout reach (c-c)	\$878	\$1098	\$1274	\$1317
107C		Cold Water Dispenser 6.57" (16.7cm) spout height at outlet 4.8" (12.2cm) spout reach (c-c)	\$758	\$948	\$1100	\$1137
107H		Hot Water Dispenser 6.57" (16.7cm) spout height at outlet 4.8" (12.2cm) spout reach (c-c)	\$758	\$948	\$1100	\$1137
9482		Pot Filler - Wall Mount 4.57" (11.6cm) spout height from wall inlet center 21.19" (53.8cm) pivoting spout reach from inlet valve (c-c) 3.51" (8.9cm) pivoting inlet valve offset (wall-center) Two shut off valves. Twin knuckles	\$1485	\$1857	\$2154	\$2228



PARDEES

			I	II	III	IV
3230-5143		Pull-Down Kitchen Faucet 10.59" (26.9cm) spout height at outlet 8.54" (21.7cm) spout reach (c-c) 17.43" overall height 1.8 gallons (6.8 liters) per minute maximum flow rate	\$1624	\$2030	\$2355	\$2436
						
3230-7173		Pull-Down Kitchen Faucet Trigger Spray Extended Reach 12.55" (31.9cm) spout height at outlet 11.19" (28.4cm) spout reach (c-c) 20.54" overall height 1.8 gallons (6.8 liters) per minute maximum flow rate	\$1988	\$2485	\$2883	\$2982
						
3230-5463		Kitchen Bridge Pull-Down Faucet Lever Handles 8.98" (22.8cm) spout height at outlet 8.29" (21.0cm) spout reach (c-c) For 8" (20.3cm) centers 1.8 gallons (6.8 liters) per minute maximum flow rate	\$2083	\$2604	\$3021	\$3125
						
3230-5413		Kitchen Bridge Faucet with Side Spray Lever Handles 11.19" (28.4cm) spout height at outlet 9" (22.9cm) spout reach (c-c) For 8" (20.3cm) centers 1.8 gallons (6.8 liters) per minute maximum flow rate	\$2950	\$3688	\$4278	\$4425
						
3230-5233		Prep/Bar Faucet 7.92" (20.1cm) spout height at outlet 7.00" (17.7cm) spout reach (c-c) 13.48" overall height 1.8 gallons (6.8 liters) per minute maximum flow rate	\$1055	\$1319	\$1530	\$1583
						
3230-5243		Prep/Bar Pull-down Faucet 8.40" (21.3cm) spout height at outlet 7.43" (18.8cm) spout reach (c-c) 14.77" overall height 1.8 gallons (6.8 liters) per minute maximum flow rate	\$1624	\$2030	\$2355	\$2436
						
3230-5603		Hot and Cold Water Dispenser 6.40" (16.3cm) spout height at outlet 4" (10.2cm) spout reach (c-c) HOT WATER TANK #5-036 SOLD SEPARATELY	\$1156	\$1445	\$1677	\$1734
						

PARDEES

		I	II	III	IV
3230-5613	 <p>Hot Water Dispenser 6.40" (16.3cm) spout height at outlet 4" (10.2cm) spout reach (c-c)</p> <p>HOT WATER TANK #5-036 SOLD SEPARATELY</p>	\$883	\$1104	\$1281	\$1325
3230-5623	 <p>Cold Water Dispenser 6.40" (16.3cm) spout height at outlet 4" (10.2cm) spout reach (c-c)</p>	\$735	\$919	\$1066	\$1103
6-027	 <p>Universal Contemporary Air Gap, Reverse Osmosis</p>	\$246	\$308	\$357	\$369
3230-5503	 <p>Pot Filler - Wall Mount 4.37" (11.1cm) spout downward offset from wall inlet center 21.39" (54.3cm) pivoting spout reach from inlet valve (c-c) 3.51" (8.9cm) pivoting inlet valve offset (wall-center) Two shut off valves. Twin knuckles</p>	\$1591	\$1989	\$2307	\$2387



NEW Pardees Kitchen Bridge Pull-Down Faucet in Midnight Chrome (30) (see page 68)

SEAGER

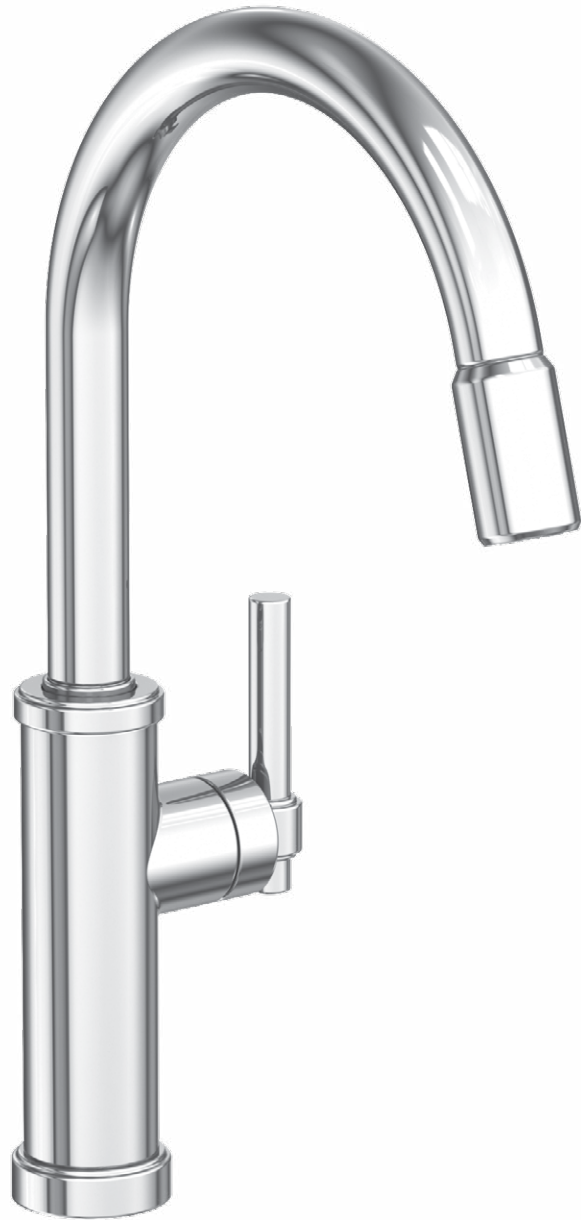

SEAGER

3180-5113



Pull-Down Kitchen Faucet
 10.81" (27.5cm) spout height at outlet
 8.52" (21.6cm) spout reach (c-c)
 17.49" overall height
 1.8 gallons (6.8 liters) per minute maximum flow rate

\$1624 \$2030 \$2355 \$2436

3180-5143



Pull-Down Kitchen Faucet
 Slim body
 10.75" (27.3cm) spout height at outlet
 8.52" (21.6cm) spout reach (c-c)
 17.43" overall height
 1.8 gallons (6.8 liters) per minute maximum flow rate

\$1624 \$2030 \$2355 \$2436

3180-5173



Pull-Down Kitchen Faucet
 Trigger Spray. Slim body
 10.58" (26.8cm) spout height at outlet
 8.78" (22.3cm) spout reach (c-c)
 18.99" overall height
 1.8 gallons (6.8 liters) per minute maximum flow rate

\$1826 \$2283 \$2648 \$2739

3180-5233



Prep/Bar Faucet
 7.92" (20.1cm) spout height at outlet
 7.00" (17.8cm) spout reach (c-c)
 13.48" overall height
 1.8 gallons (6.8 liters) per minute maximum flow rate

\$1235 \$1544 \$1791 \$1853

3180-5243



Prep/Bar Pull-Down Faucet
 8.41" (21.3cm) spout height at outlet
 7.42" (18.8cm) spout reach (c-c)
 14.77" overall height
 1.8 gallons (6.8 liters) per minute maximum flow rate

\$1624 \$2030 \$2355 \$2436

3180-5223



Prep/Bar Pull-Down Faucet
 8.69" (22.1cm) spout height at outlet
 7.40" (18.8cm) spout reach (c-c)
 14.89" overall height
 1.8 gallons (6.8 liters) per minute maximum flow rate

\$1624 \$2030 \$2355 \$2436

3180-5503



Pot Filler - Wall Mount
 4.37" (11.1cm) spout downward offset from the wall
 inlet center
 21.39" (54.3cm) pivoting spout reach from inlet valve (c-c)
 3.51" (8.9cm) pivoting inlet valve offset (wall-center)
 Two shut off valves. Twin knuckles.

\$1591 \$1989 \$2307 \$2387

SEAGER

		I	II	III	IV	
3180-5603	 <p>Hot and Cold Water Dispenser 6.35" (16.1cm) spout height at outlet 4" (10.2cm) spout reach (c-c)</p> <p>HOT WATER TANK #5-036 SOLD SEPARATELY</p>	\$1156	\$1445	\$1677	\$1734	
3180-5613	 <p>Hot Water Dispenser 6.35" (16.1cm) spout height at outlet 4" (10.2cm) spout reach (c-c)</p> <p>WATER TANK #5-036 SOLD SEPARATELY</p>	\$883	\$1104	\$1281	\$1325	
3180-5623	 <p>Cold Water Dispenser 6.35" (16.1cm) spout height at outlet 4" (10.2cm) spout reach (c-c)</p>	\$735	\$919	\$1066	\$1103	
6-027	 <p>Universal Contemporary Air Gap, Reverse Osmosis</p>	\$246	\$308	\$357	\$369	
3180-5711	 <p>Air Gap Kit IAPMO UPC® listed</p>	\$194	\$243	\$282	\$291	
3180-5721	 <p>Soap/Lotion Dispenser Requires 1-1/4" to 1-11/16" through hole Accommodates 2-3/8" maximum deck thickness</p>	\$398	\$498	\$578	\$597	
20-373		Soap/Lotion Replacement Head	\$216	\$270	\$313	\$324
125-8		Soap/Lotion Pump	\$67	—	—	—
125-9		Soap/Lotion - Replacement Bottle	\$6	—	—	—
1500-5811	 <p>Soft Touch Air Activated Disposer Switch Plugs into a standard 120VAC wall outlet</p>	\$391	\$489	\$567	\$587	



Seager Kitchen Pull-Down Faucet with Trigger Spray in Satin Bronze PVD (10) (see page 72)



STRIPLING



STRIPLING

3310-5103		<p>Pull-Down Kitchen Faucet 10.18" (25.9cm) spout height at outlet 8.58" (21.8cm) spout reach (c-c) 17.31" overall height 1.8 gallons (6.8 liters) per minute maximum flow rate</p>	\$1516	\$1895	\$2199	\$2274
3310-5203		<p>Prep/Bar Pull-Down Faucet 8.7" (22.1cm) spout height at outlet 7.47" (19.0cm) spout reach (c-c) 15.36" overall height 1.8 gallons (6.8 liters) per minute maximum flow rate</p>	\$1516	\$1895	\$2199	\$2274
3310-5503		<p>Pot Filler - Wall Mount 4.38" (11.1cm) spout downward offset from the wall inlet center 21.39" (54.3cm) pivoting spout reach from inlet valve (c-c) 3.51" (8.9cm) pivoting inlet valve offset (wall-center) Two shut off valves. Twin knuckles.</p>	\$1591	\$1989	\$2307	\$2387
3310-5603		<p>Hot and Cold Water Dispenser 7" (17.8cm) spout height at outlet 4.74" (12.0cm) spout reach (c-c)</p> <p>HOT WATER TANK #5-036 SOLD SEPARATELY</p>	\$1156	\$1445	\$1677	\$1734
3310-5613		<p>Hot Water Dispenser 7" (17.8cm) spout height at outlet 4.74" (12.0cm) spout reach (c-c)</p> <p>WATER TANK #5-036 SOLD SEPARATELY</p>	\$883	\$1104	\$1281	\$1325
3310-5623		<p>Cold Water Dispenser 7" (17.8cm) spout height at outlet 4.74" (12.0cm) spout reach (c-c)</p>	\$735	\$919	\$1066	\$1103
6-027		<p>Universal Contemporary Air Gap, Reverse Osmosis</p>	\$246	\$308	\$357	\$369
1030-5711		<p>Air Gap Kit IAPMO UPC® listed</p>	\$185	\$232	\$269	\$278

STRIPLING

			I	II	III	IV
3310-572I		Soap/Lotion Dispenser Requires 1-1/4" to 1-11/16" through hole Accommodates 2-3/8" maximum deck thickness	\$398	\$498	\$578	\$597
20-373		Soap/Lotion Replacement Head	\$216	\$270	\$313	\$324
125-8		Soap/Lotion Pump	\$67	—	—	—
125-9		Soap/Lotion - Replacement Bottle	\$6	—	—	—
2470-58II		Soft Touch Air Activated Disposer Switch Plugs into a standard 120VAC wall outlet	\$382	\$478	\$554	\$573



NEW Pardees Kitchen Pull-Down Faucet in Satin Nickel (155) (see page 68)

TAFT



TAFT

		I	II	III	IV	
2940-5103		Pull-Down Kitchen Faucet 10.31" (26.2cm) spout height at outlet 8.58" (21.8cm) spout reach (c-c) 17.43" overall height 1.8 gallons (6.8 liters) per minute maximum flow rate	\$1444	\$1805	\$2094	\$2166
2940-5123		Pull-Down Kitchen Faucet 2-hole install, separate single handle 10.21" (25.9cm) spout height at outlet 9.37" (23.8cm) spout reach (c-c) 16.80" overall height 1.8 gallons (6.8 liters) per minute maximum flow rate	\$1636	\$2045	\$2373	\$2454
2940-5173		Pull-Down Kitchen Faucet Trigger Spray. Slim body 10.53" (26.7cm) spout height at outlet 8.78" (22.3cm) spout reach (c-c) 18.93" overall height 1.8 gallons (6.8 liters) per minute maximum flow rate	\$1636	\$2045	\$2373	\$2454
2940-7173	 <i>NEW</i>	Pull-Down Kitchen Faucet Trigger Spray Extended Reach 12.61" (32 cm) spout height at outlet 11.19" (28.4 cm) spout reach (c-c) 20.60" overall height 1.8 gallons (6.8 liters) per minute maximum flow rate	\$2165	\$2707	\$3140	\$3356
2940-5463		Kitchen Bridge Pull-Down Faucet Lever Handles 9.7" (24.6cm) spout height at outlet 8.58" (21.8cm) spout reach (c-c) For 8" (20.3cm) centers 1.8 gallons (6.8 liters) per minute maximum flow rate	\$1878	\$2348	\$2724	\$2817
2940-5413	 <i>NEW</i>	Kitchen Bridge with Side Spray Lever Handles 11.20" (28.4 cm) spout height at outlet 9.00" (22.9 cm) spout reach (c-c) For 8.00" (20.3 cm) centers 1.8 gallons (6.8 liters) per minute maximum flow rate	\$2950	\$3688	\$4278	\$4425
2940-5233		Prep/Bar Faucet 7.93" (20.2cm) spout height at outlet 7.13" (18.1cm) spout reach (c-c) 13.49" overall height 1.8 gallons (6.8 liters) per minute maximum flow rate	\$1055	\$1509	\$1759	\$1759

TAFT

		I	II	III	IV	
2940-5223		Prep/Bar Pull-Down Faucet 8.18" (20.8cm) spout height at outlet 7.47" (19.0cm) spout reach (c-c) 14.83" overall height 1.8 gallons (6.8 liters) per minute maximum flow rate	\$1444	\$1805	\$2094	\$2166
2940-5503		Pot Filler - Wall Mount 4.37" (11.1cm) spout downward offset from wall inlet center 21.39" (54.3cm) pivoting spout reach from inlet valve (c-c) 3.54" (9.0cm) pivoting inlet valve offset (wall-center) Two shut off valves. Twin knuckles.	\$1591	\$1989	\$2307	\$2387
2940-5603		Hot and Cold Water Dispenser 6.80" (17.3cm) spout height at outlet 4.74" (12.0cm) spout reach (c-c) HOT WATER TANK #5-036 SOLD SEPARATELY	\$1156	\$1445	\$1677	\$1734
2940-5613		Hot Water Dispenser 6.80" (17.3cm) spout height at outlet 4.74" (12.0cm) spout reach (c-c) HOT WATER TANK #5-036 SOLD SEPARATELY	\$883	\$1104	\$1281	\$1325
2940-5623		Cold Water Dispenser 6.80" (17.3cm) spout height at outlet 4.74" (12.0cm) spout reach (c-c)	\$735	\$919	\$1066	\$1103
6-027		Universal Contemporary Air Gap, Reverse Osmosis	\$246	\$308	\$357	\$369
2940-5711		Air Gap Kit IAPMO UPC® Listed	\$194	\$243	\$282	\$291
2940-5721		Soap/Lotion Dispenser Requires 1-1/4" to 1-1/16" through hole Accommodates 2-3/8" maximum deck thickness	\$389	\$487	\$565	\$584
20-373		Soap/Lotion Replacement Head	\$216	\$270	\$313	\$324
125-8		Soap/Lotion Pump	\$67	—	—	—
125-9		Soap/Lotion - Replacement Bottle	\$6	—	—	—
2940-5811		Soft Touch Air Activated Disposer Switch Plugs into a standard 120VAC wall outlet	\$382	\$478	\$554	\$573



NEW Taft Kitchen Bridge Faucet with Side Spray in Antique Brass (06) (see page 80)

VESPERA



VESPERA

			I	II	III	IV
2500-5123		Pull-Down Kitchen Faucet 10.07" (25.6cm) spout height at outlet 8.68" (22.0cm) spout reach (c-c) 17.79" overall height 1.8 gallons (6.8 liters) per minute maximum flow rate	\$1444	\$1805	\$2094	\$2166
2500-5223		Prep/Bar Pull-Down Faucet 7.08" (18.0cm) spout height at outlet 6.66" (16.9cm) spout reach (c-c) 13.71" overall height 1.8 gallons (6.8 liters) per minute maximum flow rate	\$1444	\$1805	\$2094	\$2166
2500-5503		Pot Filler - Wall Mount 0.89" (2.4cm) spout downward offset from wall inlet center 22.69" (57.5cm) pivoting spout reach from inlet valve (c-c) 3.55" (9.0cm) pivoting inlet valve offset (wall-center) Two shut off valves. Twin knuckles.	\$1709	\$2137	\$2479	\$2564
2500-5613		Hot Water Dispenser 7.42" (18.8cm) spout height at outlet 3.93" (10.0cm) spout reach (c-c) HOT WATER TANK #5-036 SOLD SEPARATELY.	\$926	\$1158	\$1343	\$1389
2500-5623		Cold Water Dispenser 7.42" (18.8cm) spout height at outlet 3.93" (10.0cm) spout reach (c-c)	\$734	\$918	\$1065	\$1101
6-027		Universal Contemporary Air Gap, Reverse Osmosis	\$246	\$308	\$357	\$369
100		Air Gap Kit IAPMO UPC® listed	\$98	\$123	\$143	\$147
2500-5721		Soap/Lotion Dispenser Requires 1-1/4" to 1-11/16" through hole Accommodates 2-1/4" maximum deck thickness	\$389	\$487	\$565	\$584
20-405		Soap/Lotion Replacement Head	\$216	\$270	\$313	\$324
125-8		Soap/Lotion Pump	\$67	—	—	—
125-9		Soap/Lotion - Replacement Bottle	\$6	—	—	—

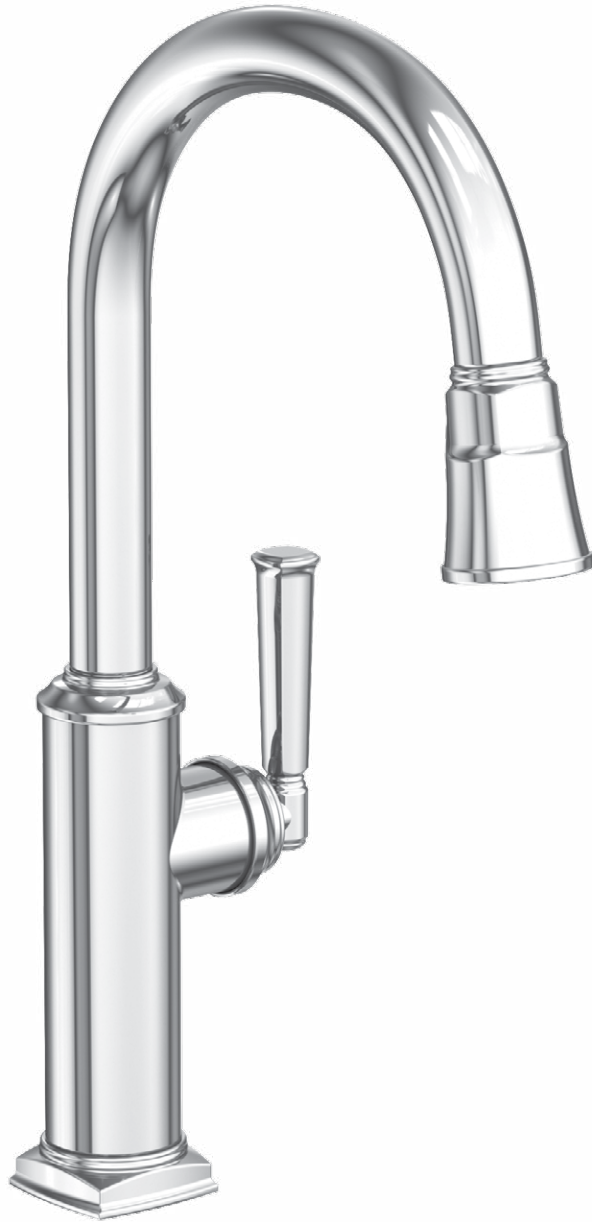

ZEMORA



ZEMORA

		I	II	III	IV	
3160-5103		Pull-Down Kitchen Faucet 10.44" (26.5cm) spout height at outlet 8.59" (21.8cm) spout reach (c-c) 17.57" overall height 1.8 gallons (6.8 liters) per minute maximum flow rate	\$1619	\$2024	\$2348	\$2429
3160-5203		Prep/Bar Pull-Down Faucet 8.31" (21.1cm) spout height at outlet. 7.48" (19.0cm) spout reach (c-c) 14.97" overall height 1.8 gallons (6.8 liters) per minute maximum flow rate	\$1619	\$2024	\$2348	\$2429
3160-5503		Pot Filler - Wall Mount 4.37" (11.1cm) spout downward offset from the wall inlet center 21.39" (54.3cm) pivoting spout reach from inlet valve (c-c) 3.51" (8.9cm) pivoting inlet valve offset (wall-center) Two shut off valves. Twin knuckles	\$1619	\$2024	\$2348	\$2429
3160-5603		Hot and Cold Water Dispenser 6.73" (17cm) spout height at outlet 4.74" (12.0cm) spout reach (c-c) HOT WATER TANK #5-036 SOLD SEPARATELY	\$1156	\$1445	\$1677	\$1734
3160-5613		Hot Water Dispenser 6.73" (17cm) spout height at outlet 4.74" (12.0cm) spout reach (c-c) WATER TANK #5-036 SOLD SEPARATELY	\$883	\$1104	\$1281	\$1325
3160-5623		Cold Water Dispenser 6.73" (17cm) spout height at outlet 4.74" (12.0cm) spout reach (c-c)	\$735	\$919	\$1066	\$1103
6-027		Universal Contemporary Air Gap, Reverse Osmosis	\$246	\$308	\$357	\$369
3180-5711		Air Gap Kit IAPMO UPC® listed	\$194	\$243	\$282	\$291

ZEMORA

		I	II	III		
3160-5811		Soft Touch Air Activated Disposer Switch Plugs into a standard 120VAC wall outlet	\$382	\$478	\$554	\$573
3160-5721		Soap/Lotion Dispenser Requires 1-1/4" to 1-1 1/16" through hole Accommodates 2-3/8" maximum deck thickness	\$398	\$498	\$578	\$597
20-373		Soap/Lotion Replacement Head	\$216	\$270	\$313	\$324
125-8		Soap/Lotion Pump	\$67	—	—	—
125-9		Soap/Lotion - Replacement Bottle	\$6	—	—	—



Taft Kitchen Pull-Down Faucet in Aged Brass (034) (see page 80)

PREP/BAR FAUCETS



PREP/BAR FAUCETS

			I	II	III	IV
3170-5203		<p>Prep/Bar Pull-Down Faucet 8.28" (21.0cm) spout height at outlet 7.47" (19.0 cm) spout reach (c-c) 14.93" overall height 1.8 gallons (6.8 liters) per minute maximum flow rate</p> <p>Matches Adams Collection</p>	\$1588	\$1985	\$2303	\$2382
1038		<p>Prep/Bar Faucet 10" (25.4cm) spout height at outlet 5.27" (13.4cm) spout reach (c-c) 13.31" overall height 1.8 gallons (6.8 liters) per minute maximum flow rate</p> <p>Matches Chesterfield Collection</p>	\$1359	\$1699	\$1971	\$2039
1030-5223		<p>Prep/Bar Pull Down Faucet 8.18" (20.8cm) spout height at outlet 7.47" (19.0cm) spout reach (c-c) 14.83" overall height 1.8 gallons (6.8 liters) per minute maximum flow rate</p> <p>Matches Chesterfield Collection</p>	\$1503	\$1879	\$2180	\$2255
1030-5233		<p>Prep/Bar Faucet 7.97" (20.2cm) spout height at outlet 7.00" (17.8cm) spout reach (c-c) 13.54" overall height 1.8 gallons (6.8 liters) per minute maximum flow rate</p> <p>Matches Chesterfield Collection</p>	\$1503	\$1879	\$2180	\$2255
938		<p>Prep/Bar Faucet 5.23" (13.3cm) spout height at outlet 6.95" (17.7cm) spout reach (c-c) 7.97" overall height 1.8 gallons (6.8 liters) per minute maximum flow rate</p> <p>Matches Chesterfield Collection</p>	\$1359	\$1699	\$1971	\$2039
928		<p>Prep/Bar Faucet 8.37" (21.3cm) spout height at outlet 5.27" (13.4cm) spout reach (c-c) 11.68" overall height 1.8 gallons (6.8 liters) per minute maximum flow rate</p> <p>Matches Chesterfield Collection</p>	\$1359	\$1699	\$1971	\$2039
9281		<p>Prep/Bar Faucet 10" (25.4cm) spout height at outlet 5.27" (13.4cm) spout reach (c-c) 13.31" overall height. 1.8 gallons (6.8 liters) per minute maximum flow rate</p> <p>Matches Chesterfield Collection</p>	\$1087	\$1359	\$1577	\$1631

PREP/BAR FAUCETS

			I	II	III	IV
1008		<p>Prep/Bar Faucet 7.12" (18.1cm) spout height at outlet 8.45" (21.4cm) spout reach (c-c) 11.01" overall height 1.8 gallons (6.8 liters) per minute maximum flow rate</p> <p>Matches Chesterfield Collection</p>	\$1404	\$1755	\$2036	\$2106
2008		<p>Prep/Bar Faucet 7.42" (18.8cm) spout height at outlet 7.13" (18.1cm) spout reach (c-c) 12.98" overall height 1.8 gallons (6.8 liters) per minute maximum flow rate</p> <p>Matches East Liner Collection</p>	\$1235	\$1544	\$1791	\$1853
1500-5233		<p>Prep/Bar Faucet 7.79" (19.8cm) spout height at outlet 7.13" (18.1cm) spout reach (c-c) 13.35" overall height 1.8 gallons (6.8 liters) per minute maximum flow rate</p> <p>Matches East Liner Collection</p>	\$1235	\$1544	\$1791	\$1853
1500-5203		<p>Prep/Bar Pull Down Faucet 7.01" (17.8cm) spout height at outlet 7.47" (19.0cm) spout reach (c-c) 13.66" overall height 1.8 gallons (6.8 liters) per minute maximum flow rate</p> <p>Matches East Liner Collection</p>	\$1536	\$1920	\$2228	\$2304
1500-5223		<p>Prep/Bar Pull-Down Faucet 7.46" (18.9cm) spout height at outlet 7.41" (18.8cm) spout reach (c-c) 13.67" overall height 1.8 gallons (6.8 liters) per minute maximum flow rate</p> <p>Matches East Liner Collection</p>	\$1536	\$1920	\$2228	\$2304
2007		<p>Prep/Bar Faucet 7.41" (18.8cm) spout height at outlet 6.13" (15.6cm) spout reach (c-c) 10.91" overall height 1.8 gallons (6.8 liters) per minute maximum flow rate</p> <p>Matches East Liner Collection</p>	\$1210	\$1513	\$1755	\$1815
3210-5203		<p>Prep/Bar Pull-Down Faucet 8.24" (20.9cm) spout height at outlet 7.47" (19.0 cm) spout reach (c-c) 14.89" overall height 1.8 gallons (6.8 liters) per minute maximum flow rate</p> <p>Matches Gavin Collection</p>	\$1516	\$1895	\$2199	\$2274

PREP/BAR FAUCETS

			I	II	III	IV
3190-5223		Prep/Bar Pull-Down Faucet 8.65" (22.0cm) spout height at outlet 7.40" (18.8cm) spout reach (c-c) 14.85" overall height 1.8 gallons (6.8 liters) per minute maximum flow rate Matches Heaney Collection	\$1480	\$1850	\$2146	\$2220
3190-5246	 <i>NEW</i>	Prep/Bar Pull-Down Faucet Paddle Handle 8.34" (21.2cm) spout height at outlet 7.43" (18.9 cm) spout reach (c-c) For single hole configurations 1.8 gallons (6.8 liters) per minute maximum flow rate Matches Heaney Collection	\$1480	\$1850	\$2146	\$2220
2470-5233		Prep/Bar Faucet 7.96" (20.2cm) spout height at outlet 7.00" (17.8cm) spout reach (c-c) 13.48" overall height 1.8 gallons (6.8 liters) per minute maximum flow rate Matches Jacobean Collection	\$1235	\$1544	\$1791	\$1853
2470-5203		Prep/Bar Faucet 7.73" (19.7cm) spout height at outlet 6.70" (17.0cm) spout reach (c-c) 9.99" overall height 1.8 gallons (6.8 liters) per minute maximum flow rate Matches Jacobean Collection	\$1264	\$1580	\$1833	\$1896
2470-5223		Prep/Bar Pull Down Faucet 8.80" (22.4cm) spout height at outlet 6.55" (16.6cm) spout reach (c-c) 14.84" overall height 1.8 gallons (6.8 liters) per minute maximum flow rate Matches Jacobean Collection	\$1500	\$1875	\$2175	\$2250
3200-5223		Prep/Bar Pull-Down Faucet 8.65" (22.0cm) spout height at outlet 7.40" (18.8cm) spout reach (c-c) 14.85" overall height 1.8 gallons (6.8 liters) per minute maximum flow rate Matches Jeter Collection	\$1768	\$2210	\$2564	\$2652
1200-5223		Prep/Bar Pull-Down Faucet 8.17" (20.8 cm) spout height at outlet 6.55" (16.6 cm) spout reach (c-c) 14.21" overall height 1.8 gallons per minute maximum flow rate Matches Metropole Collection	\$1643	\$2054	\$2383	\$2465

PREP/BAR FAUCETS

			I	II	III	IV
1208		<p>Prep/Bar Faucet 10" (25.4cm) spout height at outlet 5.27" (13.4cm) spout reach (c-c) 13.31" overall height 1.8 gallons (6.8 liters) per minute maximum flow rate</p> <p>Matches Metropole Collection</p>	\$1077	\$1347	\$1562	\$1616
3290-5233		<p>Prep/Bar Faucet 7.92" (20.1cm) spout height at outlet 7.00" (17.7cm) spout reach (c-c) 13.48" overall height 1.8 gallons (6.8 liters) per minute maximum flow rate</p> <p>Matches Muncy Collection</p>	\$1415	\$1769	\$2052	\$2123
3290-5223		<p>Prep/Bar Pull-Down Faucet 7.46" (18.9cm) spout height at outlet 7.41" (18.8cm) spout reach (c-c) 13.67" overall height 1.8 gallons (6.8 liters) per minute maximum flow rate</p> <p>Matches Muncy Collection</p>	\$1745	\$2182	\$2531	\$2618
2510-5203		<p>Prep/Bar Pull-Down Faucet 6.21" (15.8cm) spout height at outlet 6.55" (16.6cm) spout reach (c-c) 12.25" overall height 1.8 gallons (6.8 liters) per minute maximum flow rate</p> <p>Matches Nadya Collection</p>	\$1260	\$1575	\$1827	\$1890
8081		<p>Prep/Bar Faucet 10" (25.4cm) spout height at outlet 5.27" (13.4cm) spout reach (c-c) For single hole configurations 1.8 gallons (6.8 liters) per minute maximum flow rate</p> <p>Matches Nadya Collection</p>	\$1222	\$1528	\$1772	\$1833
3230-5233		<p>Prep/Bar Faucet 7.92" (20.1cm) spout height at outlet 7.00" (17.7cm) spout reach (c-c) 13.48" overall height 1.8 gallons (6.8 liters) per minute maximum flow rate</p> <p>Matches Pardees Collection</p>	\$1055	\$1319	\$1530	\$1583
3230-5243		<p>Prep/Bar Pull-down Faucet 8.40" (21.3 cm) spout height at outlet 7.43" (18.8 cm) spout reach (c-c) 14.77" overall height 1.8 gallons (6.8 liters) per minute maximum flow rate</p> <p>Matches Pardees Collection</p>	\$1624	\$2030	\$2355	\$2436



NEW

NEW

PREP/BAR FAUCETS

			I	II	III	IV
3180-5233		<p>Prep/Bar Faucet 7.92" (20.1cm) spout height at outlet 7.00" (17.8cm) spout reach (c-c) 13.48" overall height 1.8 gallons (6.8 liters) per minute maximum flow rate</p> <p>Matches Seagar Collection</p>	\$1235	\$1544	\$1791	\$1853
3180-5243		<p>Prep/Bar Pull-Down Faucet 8.41" (21.3cm) spout height at outlet 7.42" (18.8cm) spout reach (c-c) 14.77" overall height 1.8 gallons (6.8 liters) per minute maximum flow rate</p> <p>Matches Seagar Collection</p>	\$1624	\$2030	\$2355	\$2436
3310-5203		<p>Prep/Bar Pull-Down Faucet 8.7" (22.1cm) spout height at outlet 7.47" (19.0cm) spout reach (c-c) 15.36" overall height 1.8 gallons (6.8 liters) per minute maximum flow rate</p> <p>Matches Stripling Collection</p>	\$1516	\$1895	\$2199	\$2274
2940-5233		<p>Prep/Bar Faucet 7.93" (20.2cm) spout height at outlet 7.13" (18.1cm) spout reach (c-c) 13.49" overall height 1.8 gallons (6.8 liters) per minute maximum flow rate</p> <p>Matches Taft Collection</p>	\$1055	—	—	—
2940-5223		<p>Prep/Bar Pull-Down Faucet 8.18" (20.8cm) spout height at outlet 7.47" (19.0cm) spout reach (c-c) 14.83" overall height 1.8 gallons (6.8 liters) per minute maximum flow rate</p> <p>Matches Taft Collection</p>	\$1444	\$1805	\$2094	\$2166
2500-5223		<p>Prep/Bar Pull-Down Faucet 7.08" (18.0cm) spout height at outlet 6.66" (16.9cm) spout reach (c-c) 13.71" overall height 1.8 gallons (6.8 liters) per minute maximum flow rate</p> <p>Matches Vespera Collection</p>	\$1444	\$1805	\$2094	\$2166
3160-5203		<p>Prep/Bar Pull-Down Faucet 8.31" (21.1cm) spout height at outlet. 7.48" (19.0cm) spout reach (c-c) 14.97" overall height 1.8 gallons (6.8 liters) per minute maximum flow rate</p> <p>Matches Zemora Collection</p>	\$1619	\$2024	\$2348	\$2429

PREP/BAR FAUCETS

		I	II	III	IV
808	 <p>Prep/Bar Faucet 7.52" (19.1cm) spout height at outlet 5.27" (13.4cm) spout reach (c-c) 10.83" overall height For 4" (10.2cm) centers 1.8 gallons (6.8 liters) per minute maximum flow rate</p> <p>Matches Nadya Series</p>	\$797	\$997	\$1156	\$1196
1628	 <p>Prep/Bar Faucet 10" (25.4cm) spout height at outlet 5.27" (13.4cm) spout reach (c-c) 13.31" overall height 1.8 gallons (6.8 liters) per minute maximum flow rate</p> <p>Matches Chesterfield Collection</p>	\$1077	\$1347	\$1562	\$1616
1668	 <p>Prep/Bar Faucet 10" (25.4cm) spout height at outlet 5.27" (13.4cm) spout reach (c-c) 13.31" overall height 1.8 gallons (6.8 liters) per minute maximum flow rate</p> <p>Matches Chesterfield Collection</p>	\$1087	\$1359	\$1577	\$1631



Taft Bar/Prep Faucet in Antique Brass (06) (see page 80)

KITCHEN ACCESSORIES

			I	II	III	IV
100		Air Gap Kit IAPMO UPC® listed	\$98	\$123	\$143	\$147
1030-57II		Air Gap Kit IAPMO UPC® listed	\$185	\$232	\$269	\$278
2470-57II		Air Gap Kit IAPMO UPC® listed	\$258	\$323	\$375	\$387
2940-57II		Air Gap Kit IAPMO UPC® Listed	\$194	\$243	\$282	\$291
3180-57II		Air Gap Kit IAPMO UPC® listed	\$194	\$243	\$282	\$291
103		Faucet Hole Cover. 2" diameter. Solid top. For covering unused hole in sink.	\$51	\$63	\$73	\$76
III		Soft Touch Air Activated Disposer Switch. Plugs into a standard 120VAC wall outlet	\$283	\$353	\$410	\$424
1500-58II		Soft Touch Air Activated Disposer Switch Plugs into a standard 120VAC wall outlet	\$391	\$489	\$567	\$587

KITCHEN ACCESSORIES

			I	II	III	IV
2470-58II		Soft Touch Air Activated Disposer Switch Plugs into a standard 120VAC wall outlet	\$382	\$478	\$554	\$573
2940-58II		Soft Touch Air Activated Disposer Switch Plugs into a standard 120VAC wall outlet	\$382	\$478	\$554	\$573
3160-58II		Soft Touch Air Activated Disposer Switch Plugs into a standard 120VAC wall outlet	\$382	\$478	\$554	\$573
3170-58II		Soft Touch Air Activated Disposer Switch Plugs into a standard 120VAC wall outlet	\$374	\$468	\$543	\$561
3190-58II		Soft Touch Air Activated Disposer Switch Plugs into a standard 120VAC wall outlet	\$382	\$478	\$554	\$573
3210-58II		Soft Touch Air Activated Disposer Switch Plugs into a standard 120VAC wall outlet	\$382	\$478	\$554	\$573
3290-58II		Soft Touch Air Activated Disposer Switch Plugs into a standard 120VAC wall outlet	\$382	\$478	\$554	\$573
125		Soap/Lotion Dispenser Requires 1-1/4" to 1-11/16" through hole. Accommodates 2-1/4" maximum deck thickness	\$273	\$341	\$396	\$409
30-II4		Soap/Lotion Replacement Head with Pump	\$157	\$197	\$228	\$236
RP51082		Soap/Lotion Pump	\$33	—	—	—
125-16		Soap/Lotion - Replacement Bottle (16 oz)	\$6	—	—	—

KITCHEN ACCESSORIES

			I	II	III	IV
124		Soap/Lotion Dispenser Includes 2 Porcelain Inserts Soap & Lotion Requires 1-1/4" to 1-11/16" through hole Accommodates 2-1/4" maximum deck thickness	\$301	\$377	\$437	\$452
30-113 RP51082 125-16		Soap/Lotion Replacement Head with Pump Soap/Lotion Pump Soap/Lotion - Replacement Bottle (16 oz) Matches Chesterfield Collection.	\$205 \$33 \$6	\$257 — —	\$298 — —	\$308 — —
127		Soap/Lotion Dispenser Requires 1-1/4" to 1-11/16" through hole Accommodates 2-1/4" maximum deck thickness	\$352	\$440	\$511	\$528
30-115 RP51082 125-16		Soap/Lotion Replacement Head with Pump Soap/Lotion Pump Soap/Lotion - Replacement Bottle (16 oz) Matches Chesterfield Collection.	\$184 \$33 \$6	\$229 — —	\$266 — —	\$275 — —
1030-5721		Soap/Lotion Dispenser Requires 1-1/4" to 1-11/16" through hole Accommodates 2-3/8" maximum deck thickness	\$389	\$487	\$565	\$584
RP20-374 125-8 125-9		Soap/Lotion Replacement Head Soap/Lotion Pump Soap/Lotion - Replacement Bottle Matches Chesterfield Collection.	\$216 \$67 \$6	\$270 — —	\$313 — —	\$324 — —
1500-5721		Soap/Lotion Dispenser Requires 1-1/4" to 1-11/16" through hole Accommodates 2-3/8" maximum deck thickness	\$398	\$498	\$578	\$597
20-373 125-8 125-9		Soap/Lotion Replacement Head Soap/Lotion Pump Soap/Lotion - Replacement Bottle Matches East Linear Collection.	\$216 \$67 \$6	\$270 — —	\$313 — —	\$324 — —
2470-5721		Soap/Lotion Dispenser Requires 1-1/4" to 1-11/16" through hole Accommodates 2-7/16" maximum deck thickness	\$398	\$498	\$578	\$597
RP20-374 125-8 125-9		Soap/Lotion Replacement Head Soap/Lotion Pump Soap/Lotion - Replacement Bottle Matches Jacobean Collection.	\$216 \$67 \$6	\$270 — —	\$313 — —	\$324 — —
2500-5721		Soap/Lotion Dispenser Requires 1-1/4" to 1-11/16" through hole Accommodates 2-1/4" maximum deck thickness	\$389	\$487	\$565	\$584
20-405 125-8 125-9		Soap/Lotion Replacement Head Soap/Lotion Pump Soap/Lotion - Replacement Bottle Matches Vespera Collection.	\$216 \$67 \$6	\$270 — —	\$313 — —	\$324 — —

KITCHEN ACCESSORIES

			I	II	III	IV
2940-5721		Soap/Lotion Dispenser Requires 1-1/4" to 1-11/16" through hole Accommodates 2-3/8" maximum deck thickness	\$389	\$487	\$565	\$584
RP20-374		Soap/Lotion Replacement Head	\$216	\$270	\$313	\$324
125-8		Soap/Lotion Pump	\$67	—	—	—
125-9		Soap/Lotion - Replacement Bottle Matches Taft Collection.	\$6	—	—	—
3160-5721		Soap/Lotion Dispenser Requires 1-1/4" to 1-11/16" through hole Accommodates 2-3/8" maximum deck thickness	\$398	\$498	\$578	\$597
20-373		Soap/Lotion Replacement Head	\$216	\$270	\$313	\$324
125-8		Soap/Lotion Pump	\$67	—	—	—
125-9		Soap/Lotion - Replacement Bottle Matches Zemora Collection.	\$6	—	—	—
3170-5721		Soap/Lotion Dispenser Requires 1-1/4" to 1-11/16" through hole Accommodates 2-3/8" maximum deck thickness	\$398	\$498	\$578	\$597
20-373		Soap/Lotion Replacement Head	\$216	\$270	\$313	\$324
125-8		Soap/Lotion Pump	\$67	—	—	—
125-9		Soap/Lotion - Replacement Bottle Matches Adams Collection.	\$6	—	—	—
3180-5721		Soap/Lotion Dispenser Requires 1-1/4" to 1-11/16" through hole Accommodates 2-3/8" maximum deck thickness	\$398	\$498	\$578	\$597
20-373		Soap/Lotion Replacement Head	\$216	\$270	\$313	\$324
125-8		Soap/Lotion Pump	\$67	—	—	—
125-9		Soap/Lotion - Replacement Bottle Matches Muncy & Seager Collection.	\$6	—	—	—
3190-5721		Soap/Lotion Dispenser Requires 1-1/4" to 1-11/16" through hole Accommodates 2-3/8" maximum deck thickness	\$398	\$498	\$578	\$597
20-373		Soap/Lotion Replacement Head	\$216	\$270	\$313	\$324
125-8		Soap/Lotion Pump	\$67	—	—	—
125-9		Soap/Lotion - Replacement Bottle Matches Heaney Collection.	\$6	—	—	—
3200-5721		Soap/Lotion Dispenser Requires 1-1/4" to 1-11/16" through hole Accommodates 2-3/8" maximum deck thickness	\$398	\$498	\$578	\$597
20-373		Soap/Lotion Replacement Head	\$216	\$270	\$313	\$324
125-8		Soap/Lotion Pump	\$67	—	—	—
125-9		Soap/Lotion - Replacement Bottle Matches Jeter Collection.	\$6	—	—	—

KITCHEN ACCESSORIES

			I	II	III	IV
3210-5721		Soap/Lotion Dispenser Requires 1-1/4" to 1-11/16" through hole Accommodates 2-3/8" maximum deck thickness	\$398	\$498	\$578	\$597
RP20-374		Soap/Lotion Replacement Head	\$216	\$270	\$313	\$324
125-8		Soap/Lotion Pump	\$67	—	—	—
125-9		Soap/Lotion - Replacement Bottle Matches Gavin Collection.	\$6	—	—	—
3310-5721		Soap/Lotion Dispenser Requires 1-1/4" to 1-11/16" through hole Accommodates 2-3/8" maximum deck thickness	\$398	\$498	\$578	\$597
20-373		Soap/Lotion Replacement Head	\$216	\$270	\$313	\$324
125-8		Soap/Lotion Pump	\$67	—	—	—
125-9		Soap/Lotion - Replacement Bottle Matches Stripling Collection.	\$6	—	—	—
5-036		Hot Water Tank Use with parts 106, 106H, 107, 107H, 108, 108H, 1030-5603, 1030-5613, 1200-5603, 1200-5613, 2470-5603, 2470-5613, 2500-5613, 2940-5603, 2940-5613, 3160-5603, 3160-5613, 3170-5603, 3170-5613, 3180-5603, 3180-5613, 3910-5603, 3190-5613, 3200-5603, 3200-5613, 3210-5603, 3210-5613, 3230-5603, 3230-5613, 3290-5603, 3290-5613, 3310-5603, 3310-5613.	\$787	—	—	—
98000		Brass Protech is exclusively made to clean, polish and protect Newport Brass products.	\$39	—	—	—

As a space of ritual and restoration, the bath calls for objects of clarity, restraint, and enduring beauty. Crafted by hand in solid brass, our fixtures and fittings reflect a thoughtful balance of sculptural form and lasting performance, spanning clean, architectural lines to timeless, expressive silhouettes. Each collection offers complete freedom of expression, with every style available in all 22 of our hand-applied finishes.

A comprehensive offering ensures cohesion throughout the room. Widespread, wall-mount, and single-hole faucets integrate seamlessly with tub fillers, shower systems, hand showers, and bidets, creating a unified design language. Decorative drains and considered accessories complete the composition resulting in a space that elevates the everyday and endures for generations.



A photograph of a modern bathroom vanity. The vanity is a light-colored, possibly white or light grey, countertop. On the countertop, there are three dark, minimalist fixtures. From left to right: a small square pedestal with a wide, flat top; a tall, rectangular pedestal with a wide, flat top; and another small square pedestal with a wide, flat top. The background is a textured, light-colored wall. The word "BATH" is overlaid in white, sans-serif capital letters in the center of the image.

BATH

BATH COLLECTIONS

NUMERICAL INDEX

COLLECTION	PAGE
ALEXANDRIA	110
AMISA	114
ASTOR	118
AYLESBURY	128
CHESTERFIELD	138
CLEMENS	150
DORRANCE	156
EAST LINEAR	162
GRIFFEY	176
ITHACA	182
JACOBAN	188
JOFFREY	196
KIMBELL	200

COLLECTION	PAGE
MALVINA	206
METROPOLE	212
MIRO	222
MUNCY	228
PARDEES	234
PAVANI	240
SEAPORT	250
SECANT	256
TAFT	268
TOLMIN	272
VANDER	278
VICTORIA	282

BATH COLLECTIONS

ALEXANDRIA
PAGE 110



1090

AMISA
PAGE 114



980

ASTOR
PAGE 118



920

AYLESBURY
PAGE 128



2400

CHESTERFIELD
PAGE 138



930

CLEMENS
PAGE 150



3250

DORRANCE
PAGE 156



2970

EAST LINEAR
PAGE 162



990

GRIFFEY
PAGE 176



3273

ITHACA
PAGE 182



2550

JACOBAN
PAGE 188



2460

JOFFREY
PAGE 196



2570

KIMBELL
PAGE 200



3420C

MALVINA
PAGE 206

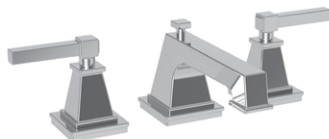

3140

METROPOLE
PAGE 212



1200

MIRO
PAGE 222



1600

MUNCY
PAGE 228



3300

PARDEES
PAGE 234



3230

PAVANI
PAGE 240



3100

SEAPORT
PAGE 250



850

SECANT
PAGE 256



2040

TAFT
PAGE 268



2940

TOLMIN
PAGE 272



3320

VANDER
PAGE 278



2910

VICTORIA
PAGE 282



1760

BATH









ALEXANDRIA



ALEXANDRIA

			I	II	III	IV
1090		Widespread Lavatory Faucet 8" centers 1/2" valves. Spout reach 5.33" 	\$1773	\$2217	\$2571	\$2660
3-1096		Roman Tub Faucet Spout reach 9.44" VALVE REQUIRED	\$1836	\$2295	\$2663	\$2754
1-506		3/4" valves for above. Quick connect included	\$564	—	—	—
3-1097		Roman Tub Faucet with Hand Shower Spout reach 9.44" VALVE REQUIRED 	\$2136	\$2692	\$3108	\$3204
1-507		3/4" valve for above Includes hose and quick connect	\$1134	—	—	—
2-250		Tub Spout 1/2" NPT inlet fitting 6.29" spout length	\$289	\$362	\$419	\$434
4-1094BP		Balanced Pressure Shower Trim Less showerhead, shower arm VALVE REQUIRED	\$793	\$1029	\$1189	\$1189
1-684		Newport Brass Balanced Pressure Valve, 3 port with service stops, universal 1/2" NPT See Shower & Drain Sections to complete shower	\$365	—	—	—
5-1092BP		Balanced Pressure Tub and Shower Trim Less tub spout, showerhead, shower arm VALVE REQUIRED	\$894	\$1162	\$1340	\$1341
1-685		Newport Brass Balanced Pressure Valve with diverter, 4 port with service stops, universal 1/2" NPT See Shower & Drain Sections to complete shower	\$503	—	—	—
3-803TR		1/2" Thermostatic Trim Plate with Handles Integrated diverter handle with independent temperature control VALVE REQUIRED, see page 338	\$786	\$983	\$1140	\$1179

ALEXANDRIA

			I	II	III	IV
3-804TR		3/4" Thermostatic Trim Plate with Handle VALVE REQUIRED	\$639	\$799	\$927	\$959
1-540		3/4" Thermostatic Rough-in Valve	\$1020	—	—	—
3-248		Diverter/Flow Control Trim Use with stop or diverter valves, see page 347-348	\$427	\$545	\$654	\$654
22-13		Double Robe Hook	\$241	\$302	\$350	\$362
22-09		Towel Ring	\$264	\$330	\$383	\$396
22-01		18" Towel Bar	\$382	\$477	\$554	\$573
22-02		24" Towel Bar	\$399	\$499	\$579	\$599
22-27		Single Post Toilet Tissue Holder	\$399	\$499	\$579	\$599
22-28		Tissue Holder	\$399	\$499	\$579	\$599

Coordinating Grab Bars starting on page 358



NEW Taft Mid-Height Lavatory Faucet in French Gold (24A) (see page 268)







AMISA

		I	II	III	IV
980	 <p>Widespread Lavatory Faucet 1/2" valves. Spout reach 4.75". 8" centers</p> 	\$1357	\$1697	\$1968	\$2036
1020	 <p>Widespread Lavatory Faucet 1/2" valves. Spout reach 6.12". 8" centers</p> 	\$1357	\$1697	\$1968	\$2036
3-1026	 <p>Roman Tub Faucet Spout Spout reach 9.44"</p> <p>VALVE REQUIRED</p>	\$1836	\$2295	\$2663	\$2754
I-506	 <p>3/4" valves for above. Quick connect included</p>	\$564	—	—	—
3-1027	 <p>Roman Tub Faucet with Hand Shower Spout reach 9.44"</p> <p>VALVE REQUIRED</p> 	\$2136	\$2670	\$3098	\$3204
I-507	 <p>3/4" valve for above Includes hose and quick connect</p>	\$1134	—	—	—
3-985	 <p>Wall Mount Tub Faucet</p> <p>VALVE REQUIRED</p>	\$1090	\$1363	\$1581	\$1635
I-500U	 <p>2-valve rough with 1/2" NPT inlets & outlet</p>	\$477	—	—	—
2-250	 <p>Tub Spout 1/2" NPT inlet fitting 6.29" spout length</p>	\$289	\$362	\$419	\$434
4-984BP	 <p>Balanced Pressure Shower Trim Less showerhead, shower arm</p> <p>VALVE REQUIRED</p>	\$704	\$880	\$1021	\$1056
I-684	 <p>Newport Brass Balanced Pressure Valve, 3 port with service stops, universal 1/2" NPT & direct sweat connections</p> <p>See Shower & Drain Sections to complete shower</p>	\$365	—	—	—

			I	II	III	IV
5-982BP		Balanced Pressure Tub & Shower Trim Less tub spout, showerhead, shower arm	\$794	\$993	\$1152	\$1191
1-685		VALVE REQUIRED Newport Brass Balanced Pressure Valve with diverter, 4 port with service stops, universal 1/2" NPT & direct sweat connections See Shower & Drain Sections to complete shower	\$503	—	—	—
3-984BP		Balanced Pressure Shower Set VALVE REQUIRED	\$863	\$1121	\$1297	\$1297
1-684		Newport Brass Balanced Pressure Valve, 3 port with service stops, universal 1/2" NPT & direct sweat connections See Shower & Drain Sections to complete shower	\$365	—	—	—
3-803TR		1/2" Thermostatic Trim Plate with Handles Integrated diverter handle with independent temperature control VALVE REQUIRED, see page 338	\$786	\$983	\$1140	\$1179
3-804TR		3/4" Thermostatic Trim Plate with Handle VALVE REQUIRED	\$639	\$799	\$927	\$959
1-540		3/4" Thermostatic Rough-in Valve	\$1020	—	—	—
3-188H		Diverter/Flow Control Trim Use with stop or diverter valves, see page 347-348	\$405	\$520	\$624	\$624
989		Bidet Set 1/2" valves. Includes Bottom Spray with vacuum breaker, 4 hole mount bidet See page 330 for complete Bidet offering	\$2040	\$2620	\$3147	\$3240
15-09		Towel Ring	\$257	\$321	\$372	\$385

AMISA

			I	II	III	IV
15-01		18" Towel Bar	\$348	\$435	\$505	\$522
15-02		24" Towel Bar	\$368	\$460	\$533	\$551
15-13		Double Robe Hook	\$241	\$302	\$350	\$362
15-27		Hanging Toilet Tissue Holder	\$368	\$460	\$533	\$551
15-28		Double Post Toilet Tissue Holder	\$368	\$460	\$533	\$551





Coordinating Grab Bars starting on page 358















ASTOR









			I	II	III	IV
910		Widespread Lavatory Faucet with Lever Handles 1/2" valves. Spout reach 5.62" 8" centers	\$1198	\$1498	\$1738	\$1797
						
910C		Widespread Lavatory Faucet with Lever handles 1/2" valves. Spout reach 5.82" 8" centers	\$1198	\$1498	\$1738	\$1797
						
920		Widespread Lavatory Faucet with Cross Handles 1/2" valves. Spout reach 5.62" 8" centers	\$1198	\$1498	\$1738	\$1797
						
920C		Widespread Lavatory Faucet with Cross Handles 1/2" valves. Spout reach 5.82" 8" centers	\$1198	\$1498	\$1738	\$1797
						
890		Widespread Lavatory Faucet. 1/2" valves. Spout reach 6.12". 8" centers	\$1198	\$1498	\$1738	\$1797
						
9203		Single Hole Lavatory Faucet 4.59" spout height at outlet 6.20" spout reach (reach) 10.63" overall height Includes pop-up assembly Does not work with #101 cover plate	\$1268	\$1654	\$1901	\$1902
						
9208		Single Hole Vessel Faucet Overall height 13.44". Spout reach 6.20" Spout height from base 7.44" Drain not included For lavatory sink drains see Fittings #330, 3301, 3302 or 3303 Does not work with #101 cover plate	\$1408	\$1760	\$2042	\$2112
						

ASTOR



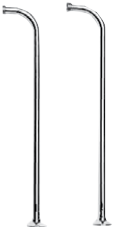

		I	II	III	IV
3-911	 <p>Wall Mount Lavatory Faucet with Lever handles Spout reach 7.50" 8" centers Drain not included See Fittings #330, 3301, 302 or 3303</p> <p>VALVE REQUIRED</p> 	\$944	\$1180	\$1369	\$1416
I-532U	2-valve rough with 1/2" NPT inlets & outlet	\$477	—	—	—
3-921	 <p>Wall Mount Lavatory Faucet Cross handles. Spout reach 7.50" 8" centers. Drain not included See Fittings #330, 3301, 3302 or 3303</p> <p>VALVE REQUIRED</p> 	\$944	\$1180	\$1369	\$1416
I-532U	2-valve rough with 1/2" NPT inlets & outlet	\$477	—	—	—
3-916	 <p>Roman Tub Faucet with Lever Handles Spout reach 9.27"</p> <p>VALVE REQUIRED</p>	\$1520	\$1900	\$2204	\$2280
I-502	3/4" valve for above, quick connect included	\$564	—	—	—
3-926	 <p>Roman Tub Faucet with Cross Handles Spout reach 9.27"</p> <p>VALVE REQUIRED</p>	\$1520	\$1900	\$2204	\$2280
I-502	3/4" valve for above, quick connect included	\$564	—	—	—
3-896	 <p>Roman Tub Faucet Spout reach 9.44"</p> <p>VALVE REQUIRED</p>	\$1520	\$1900	\$2204	\$2280
I-506	3/4" valves for above. Quick connect included	\$564	—	—	—
3-917	 <p>Roman Tub Faucet with Hand Shower with Lever Handles Spout reach 9.27"</p> <p>VALVE REQUIRED</p> 	\$1820	\$2275	\$2639	\$2730
I-503	3/4" valve for above. Includes hose and quick connect	\$1134	—	—	—

ASTOR











		I	II	III	IV
3-927	 <p>Roman Tub Faucet with Hand Shower Cross Handles Spout reach 9.27"</p> <p>VALVE REQUIRED</p> 	\$1820	\$2275	\$2639	\$2730
I-503	<p>3/4" valve for above. Includes hose and quick connect</p>	\$1134	—	—	—
3-897	 <p>Roman Tub Faucet with Hand Shower Spout reach 9.44"</p> <p>VALVE REQUIRED</p> 	\$1820	\$2275	\$2639	\$2730
I-507	<p>3/4" valve for above Includes hose and quick connect</p>	\$1134	—	—	—
3-915	 <p>Wall Mount Tub Faucet with Lever Handles</p> <p>VALVE REQUIRED</p>	\$1090	\$1363	\$1581	\$1635
I-500U	 <p>2-valve rough with 1/2" NPT inlets & outlet</p>	\$477	—	—	—
3-925	 <p>Wall Mount Tub Faucet</p> <p>VALVE REQUIRED</p>	\$1090	\$1363	\$1581	\$1635
I-500U	 <p>2-valve rough with 1/2" NPT inlets & outlet</p>	\$477	—	—	—
910-4273	 <p>Exposed Tub and Hand Shower Set Deck Mount Lever Handles 7.25" centers. Spout reach 9.11" Includes: 281 Hand Shower</p> 	\$2171	\$2713	\$3147	\$3256
920-4272	 <p>Exposed Tub and Hand Shower Set Deck Mount Cross Handles 7.25" centers. Spout reach 9.11" Includes: 281 Hand Shower</p> 	\$2171	\$2713	\$3147	\$3256

			I	II	III	IV
910-4283		Exposed Tub and Hand Shower Set Wall Mount Lever Handles. 6" centers. Spout reach 7" Includes: 281 Hand Shower No. 284, 59" Hose. Floor-mount kit item 3-196 or 3-226 sold separately	\$2071	\$2589	\$3003	\$3107
						
I-378		Required Rough for Exposed Tub Filler For use with 3-196 or 3-226 tub risers	\$549	—	—	—
920-4282		Exposed Tub and Hand Shower Set Wall Mount Cross Handles 6" centers. Spout reach 7" Includes: 281 Hand Shower Floor-mount kit item 3-196 or 3-226 sold separately	\$2071	\$2589	\$3003	\$3107
						
I-378		Required Rough for Exposed Tub Filler For use with 3-196 or 3-226 tub risers	\$549	—	—	—
3-196		Floor Mount Kit for Exposed Tub Sets Set includes: 2 each Floor Flanges 2 each 3/4" Risers - 31" high Decorative Stabilizer Kit sold separately	\$767	\$980	\$1175	\$1175
3-226		Same as above only 24" high	\$736	\$944	\$1135	\$1135
3-192		3/4" Shut-off Valves for above (1 pair hot & cold)	\$1077	\$1347	\$1562	\$1616
2-734		Decorative Stabilizer Kit for Exposed Tub Floor Riser Kits Adjustable for risers that are 6" to 9" apart Includes 1-1/2" finished ring for connecting kit to tub overflow pipe. Finished plate for wall mounting up to 10" center of riser pipes	\$378	\$472	\$547	\$566
		 Wall Mount Plate				
910-4261		Free Standing Tub Filler 37.22" (94.5cm) spout height at outlet (from floor) 8.73" (22.2cm) spout reach 43.3" overall height 12 gallons (45.2 liters) per minute maximum flow rate (spout) 1.8 gallons (6.8 liters) per minute maximum flow rate (hand shower)	\$2862	\$3578	\$4150	\$4293
						
I-339	See page 304	Rough for Freestanding Tub Filler For subfloor and concrete floor installations 4.53" overall height 7.20" overall base diameter Universal 3/4" NPT and 1/2" direct sweat connections Test caps included	\$434	—	—	—

ASTOR

			I	II	III	IV
2-144		Tub Spout 1/2" NPT inlet fitting 7.56" spout length	\$277	\$347	\$402	\$416
4-914BP		Balanced Pressure Shower Trim with Lever Handle Less showerhead, shower arm	\$704	\$880	\$1021	\$1056
1-684		VALVE REQUIRED Newport Brass Balanced Pressure Valve, 3 port with service stops, universal 1/2" NPT & direct sweat connections See Shower & Drain Sections to complete shower	\$365	—	—	—
4-924BP		Balanced Pressure Shower Set with Cross Handle Less showerhead, shower arm	\$704	\$880	\$1021	\$1056
1-684		VALVE REQUIRED Newport Brass Balanced Pressure Valve, 3 port with service stops, universal 1/2" NPT & direct sweat connections See Shower & Drain Sections to complete shower	\$365	—	—	—
5-912BP		Balanced Pressure Tub & Shower Trim with Lever Handle Less tub spout, showerhead, shower arm	\$794	\$993	\$1152	\$1191
1-685		VALVE REQUIRED Newport Brass Balanced Pressure Valve with diverter, 4 port with service stops, universal 1/2" NPT & direct sweat connections See Shower & Drain Sections to complete shower	\$503	—	—	—
5-922BP		Balanced Pressure Tub & Shower Trim with Cross Handle Less tub spout, showerhead, shower arm	\$794	\$993	\$1152	\$1191
1-685		VALVE REQUIRED Newport Brass Balanced Pressure Valve with diverter, 4 port with service stops, universal 1/2" NPT & direct sweat connections See Shower & Drain Sections to complete shower	\$503	—	—	—
3-914BP		Balanced Pressure Shower Set. Lever Handle	\$863	\$1079	\$1252	\$1295
1-684		VALVE REQUIRED Newport Brass Balanced Pressure Valve, 3 port with service stops, universal 1/2" NPT & direct sweat connections	\$365	—	—	—

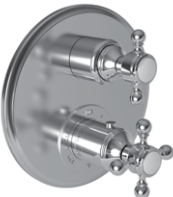
ASTOR







			I	II	III	IV
3-924BP		Balanced Pressure Shower Set. Cross Handle VALVE REQUIRED	\$863	\$1079	\$1252	\$1295
1-684		Newport Brass Balanced Pressure Valve, 3 port with service stops, universal 1/2" NPT & direct sweat connections	\$365	—	—	—
3-912BP		Balanced Pressure Tub & Shower Set. Lever Handle VALVE REQUIRED	\$1142	\$1428	\$1656	\$1713
1-685	 	Newport Brass Balanced Pressure Valve with diverter, 4 port with service stops, universal 1/2" NPT & direct sweat connections	\$503	—	—	—
3-922BP		Balanced Pressure Tub & Shower Set. Cross Handle VALVE REQUIRED	\$1142	\$1428	\$1656	\$1713
1-685	 	Newport Brass Balanced Pressure Valve with diverter, 4 port with service stops, universal 1/2" NPT & direct sweat connections	\$503	—	—	—
3-913TR		1/2" Thermostatic Trim Plate with Handles Integrated diverter handle with independent temperature control VALVE REQUIRED, see page 338	\$786	\$983	\$1140	\$1179
3-923TR		1/2" Thermostatic Trim Plate with Handles Integrated diverter handle with independent temperature control VALVE REQUIRED, see page 338	\$786	\$983	\$1140	\$1179
3-913TS		1/2" Thermostatic Trim Plate with Handles Integrated diverter handle with independent temperature control. VALVE REQUIRED, see page 338	\$786	\$983	\$1140	\$1179

ASTOR

			I	II	III	IV
3-923TS		1/2" Thermostatic Trim Plate with Handles Integrated diverter handle with independent temperature control VALVE REQUIRED, see page 338	\$786	\$983	\$1140	\$1179
3-914TR		3/4" Thermostatic Trim Plate with Handle VALVE REQUIRED	\$639	\$799	\$927	\$959
I-54O		3/4" Thermostatic Rough-in Valve	\$1020	—	—	—
3-924TR		3/4" Thermostatic Trim Plate with Handle VALVE REQUIRED	\$639	\$799	\$927	\$959
I-54O		3/4" Thermostatic Rough-in Valve	\$1020	—	—	—
3-343		Diverter/Flow Control Trim Use with stop or diverter valves, see page 347-348	\$253	\$324	\$390	\$390
3-163		Diverter/Flow Control Trim with Arrow insert	\$302	\$378	\$438	\$453
3-163B		Diverter/Flow Control Trim with Plain insert Use with stop or diverter valves, see page 347-348	\$276	\$345	\$401	\$414
929		Bidet Set 1/2" valves. Includes Bottom Spray, with vacuum breaker, 4 hole mount bidet. See page 330 for complete Bidet offering.	\$1907	\$2446	\$2936	\$3025
890-1410		Towel Ring	\$197	\$246	\$285	\$295
890-1400		Towel Ring - Open	\$246	\$307	\$356	\$368

BATH

ASTOR

			I	II	III	IV
890-1230		18" Towel Bar	\$264	\$330	\$383	\$396
890-1250		24" Towel Bar	\$309	\$387	\$449	\$464
890-1650		Single Robe Hook	\$87	\$108	\$125	\$130
890-1660		Double Robe Hook	\$176	\$220	\$255	\$264
890-1510		Hanging Toilet Tissue Holder	\$246	\$307	\$356	\$368
890-1500		Double Post Toilet Tissue Holder	\$289	\$362	\$420	\$434

Coordinating Grab Bars starting on page 358 and Baskets starting on page 354











Astor Widespread Lavatory Faucet in Aged Brass (034) (see page 118)









AYLESBURY











AYLESBURY

			I	II	III	IV
2430		Widespread Lavatory Faucet with Lever Handles 1/2" valves Spout reach 5.14". 8" centers	\$1357	\$1697	\$1968	\$2036
						
2410		Widespread Lavatory Faucet with Lever Handles 1/2" valves Spout reach 5.09". 8" centers	\$1357	\$1697	\$1968	\$2036
						
2450		Widespread Lavatory Faucet with Lever Handles 1/2" valves Spout reach 5.24". 8" centers	\$1357	\$1697	\$1968	\$2036
						
2420		Widespread Lavatory Faucet with Cross Handles 1/2" valves Spout reach 5.14". 8" centers	\$1357	\$1697	\$1968	\$2036
						
2400		Widespread Lavatory Faucet with Cross Handles 1/2" valves Spout reach 5.09". 8" centers	\$1357	\$1697	\$1968	\$2036
						
2440		Widespread Lavatory Faucet with Cross Handles 1/2" valves Spout reach 5.24". 8" centers	\$1357	\$1697	\$1968	\$2036
						
2433		Single Hole Lavatory Faucet 5.48" spout height at outlet 5.04" spout reach. 8.14" overall height Includes pop-up assembly	\$1168	\$1460	\$1694	\$1752
						
101		Cover Plate 6" x 2-1/2"	\$120	\$157	\$174	\$180







AYLESBURY

		I	II	III	IV
3-241I	 <p>Wall Mount Lavatory Faucet with Lever Handles Spout reach 7.25" 8" centers Drain not included See Fittings # 330, 3301, 3302 or 3303</p> <p>VALVE REQUIRED</p> 	\$944	\$0	\$1369	\$1416
I-532U	2-valve rough with 1/2" NPT inlets & outlet	\$477	—	—	—
3-245I	 <p>Wall Mount Lavatory Faucet with Lever Handles Spout reach 6.88" 8" centers Drain not included See Fittings # 330, 3301, 3302 or 3303</p> <p>VALVE REQUIRED</p> 	\$944	\$1180	\$1369	\$1416
I-532U	2-valve rough with 1/2" NPT inlets & outlet	\$477	—	—	—
3-240I	 <p>Wall Mount Lavatory Faucet with Cross Handles Spout reach 7.25" 8" centers Drain not included See Fittings # 330, 3301, 3302 or 3303</p> <p>VALVE REQUIRED</p> 	\$944	\$1180	\$1369	\$1416
I-532U	2-valve rough with 1/2" NPT inlets & outlet	\$477	—	—	—
3-244I	 <p>Wall Mount Lavatory Faucet with Cross Handles Spout reach 6.88" 8" centers Drain not included See Fittings # 330, 3301, 3302 or 3303</p> <p>VALVE REQUIRED</p> 	\$944	\$1180	\$1369	\$1416
I-532U	2-valve rough with 1/2" NPT inlets & outlet	\$477	—	—	—
3-2416	 <p>Roman Tub Faucet with Lever Handles Spout reach 7.23"</p> <p>VALVE REQUIRED</p>	\$1520	\$1900	\$2204	\$2280
I-502	3/4" valve for above, quick connect included	\$564	—	—	—

AYLESBURY

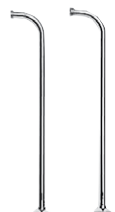
			I	II	III	IV
3-2456		Roman Tub Faucet with Lever Handles Spout reach 7.37"	\$1520	\$1900	\$2204	\$2280
I-502		VALVE REQUIRED 3/4" valve for above, quick connect included	\$564	—	—	—
3-2417		Roman Tub Faucet with Hand Shower and Lever Handles Spout reach 7.23"	\$1820	\$2275	\$2639	\$2730
I-503		VALVE REQUIRED 3/4" valve for above. Includes hose and quick connect	\$1134	—	—	—
3-2457		Roman Tub Faucet with Hand Shower and Lever Handles Spout reach 7.37"	\$1820	\$2275	\$2639	\$2730
I-503		VALVE REQUIRED 3/4" valve for above. Includes hose and quick connect	\$1134	—	—	—
3-2415		Wall Mount Tub Faucet with Lever Handles	\$1090	\$1363	\$1581	\$1635
I-500U		VALVE REQUIRED 2-valve rough with 1/2" NPT inlets & outlet	\$477	—	—	—
3-2455		Wall Mount Tub Faucet with Lever Handles	\$1090	\$1363	\$1581	\$1635
I-500U		VALVE REQUIRED 2-valve rough with 1/2" NPT inlets & outlet	\$477	—	—	—
2400-4273		Exposed Tub and Hand Shower Set with Lever Handles Deck Mount 7.25" centers. Spout reach 9.11" Includes: 281 Hand Shower	\$2081	\$2602	\$3082	\$3122
						
2400-4272		Exposed Tub and Hand Shower Set Deck Mount Cross Handles 7.25" centers. Spout reach 9.11". Includes: 281 Hand Shower	\$2081	\$2602	\$3082	\$3122
						







AYLESBURY

			I	II	III	IV
2400-4283		Exposed Tub and Hand Shower Set Wall Mount Lever Handles 6" centers. Spout reach 7" Includes: 28l Hand Shower Floor-mount kit item 3-196 or 3-226 sold separately	\$2081	\$2602	\$3018	\$3122
						
1-378		Required Rough for Exposed Tub Filler For use with 3-196 or 3-226 tub risers	\$549	—	—	—
2400-4282		Exposed Tub and Hand Shower Set with Cross Handles Wall Mount 6" centers. Spout reach 7" Includes: 28l Hand Shower Floor-mount kit item 3-196 or 3-226 sold separately	\$2081	\$2602	\$3018	\$3122
						
1-378		Required Rough for Exposed Tub Filler For use with 3-196 or 3-226 tub risers	\$549	—	—	—
3-196		Floor Mount Kit for Exposed Tub Sets Set includes: 2 each Floor Flanges 2 each 3/4" Risers - 31" high Decorative Stabilizer Kit sold separately	\$767	\$980	\$1175	\$1175
3-226		Same as above only 24" high	\$736	\$944	\$1135	\$1135
3-192		3/4" Shut-off Valves for above (1 pair hot & cold).	\$1077	\$1347	\$1562	\$1616
2-734		Decorative Stabilizer Kit for Exposed Tub Floor Riser Kits Adjustable for risers that are 6" to 9" apart Includes 1-1/2" finished ring for connecting kit to tub overflow pipe. Finished plate for wall mounting up to 10" center of riser pipes.	\$378	\$472	\$547	\$566
		Wall Mount Plate				
3-383		Tub Spout 1/2" NPT inlet fitting 7.82" spout length	\$296	\$370	\$429	\$444
3-669		Tub Spout 1/2" NPT inlet fitting 9.83" spout length	\$296	\$370	\$429	\$444









AYLESBURY

			I	II	III	IV
4-2414BP		Balanced Pressure Shower Trim with Lever Handle Less showerhead, shower arm	\$780	\$975	\$1131	\$1171
I-684		VALVE REQUIRED Newport Brass Balanced Pressure Valve, 3 port with service stops, universal 1/2" NPT & direct sweat connections See Shower & Drain Sections to complete shower	\$365	—	—	—
4-2454BP		Balanced Pressure Shower Trim with Lever Handle. Less showerhead, shower arm	\$780	\$975	\$1131	\$1171
I-684		VALVE REQUIRED Newport Brass Balanced Pressure Valve, 3 port with service stops, universal 1/2" NPT & direct sweat connections See Shower & Drain Sections to complete shower	\$365	—	—	—
4-2404BP		Balanced Pressure Shower Trim with Cross Handle. Less showerhead, shower arm	\$780	\$975	\$1131	\$1171
I-684		VALVE REQUIRED Newport Brass Balanced Pressure Valve, 3 port with service stops, universal 1/2" NPT & direct sweat connections See Shower & Drain Sections to complete shower	\$365	—	—	—
4-2444BP		Balanced Pressure Shower Trim with Cross Handle Less showerhead, shower arm	\$780	\$975	\$1131	\$1171
I-684		VALVE REQUIRED Newport Brass Balanced Pressure Valve, 3 port with service stops, universal 1/2" NPT & direct sweat connections See Shower & Drain Sections to complete shower	\$365	—	—	—
5-2412BP		Balanced Pressure Tub & Shower Trim with Lever Handle Less tub spout, showerhead, shower arm	\$889	\$1112	\$1290	\$1334
I-685		VALVE REQUIRED Newport Brass Balanced Pressure Valve with diverter, 4 port with service stops, universal 1/2" NPT & direct sweat connections	\$503	—	—	—
5-2452BP		Balanced Pressure Tub & Shower Trim with Lever Handle Less tub spout, showerhead, shower arm	\$889	\$1112	\$1290	\$1334
I-685		VALVE REQUIRED Newport Brass Balanced Pressure Valve with diverter, 4 port with service stops, universal 1/2" NPT & direct sweat connections See Shower & Drain Sections to complete shower	\$503	—	—	—









AYLESBURY

			I	II	III	IV
5-2402BP		Balanced Pressure Tub & Shower Trim with Cross Handle Less tub spout, showerhead, shower arm	\$889	\$1112	\$1290	\$1334
1-685		VALVE REQUIRED Newport Brass Balanced Pressure Valve with diverter, 4 port with service stops, universal 1/2" NPT & direct sweat connections	\$503	—	—	—
5-2442BP		Balanced Pressure Tub & Shower Trim with Cross Handle Less tub spout, showerhead, shower arm	\$889	\$1112	\$1290	\$1334
1-685		VALVE REQUIRED Newport Brass Balanced Pressure Valve with diverter, 4 port with service stops, universal 1/2" NPT & direct sweat connections See Shower & Drain Sections to complete shower	\$503	—	—	—
3-2414BP		Balanced Pressure Shower Set. Lever Handle	\$1372	\$1715	\$1990	\$2058
1-684		VALVE REQUIRED Newport Brass Balanced Pressure Valve, 3 port with service stops, universal 1/2" NPT & direct sweat connections	\$365	—	—	—
3-2454BP		Balanced Pressure Shower Set. Lever Handle	\$1372	\$1715	\$1990	\$2058
1-684		VALVE REQUIRED Newport Brass Balanced Pressure Valve, 3 port with service stops, universal 1/2" NPT & direct sweat connections	\$365	—	—	—
3-2412BP		Balanced Pressure Tub & Shower Set. Lever Handle	\$1442	\$1803	\$2091	\$2163
1-685		VALVE REQUIRED Newport Brass Balanced Pressure Valve with diverter, 4 port with service stops, universal 1/2" NPT & direct sweat connections	\$503	—	—	—
3-2404BP		Balanced Pressure Shower Set. Cross Handle	\$1372	\$1715	\$1990	\$2058
1-684		VALVE REQUIRED Newport Brass Balanced Pressure Valve, 3 port with service stops, universal 1/2" NPT & direct sweat connections	\$365	—	—	—







AYLESBURY

			I	II	III	IV
3-2413TR		1/2" Thermostatic Trim Plate with Handles Integrated diverter handle with independent temperature control VALVE REQUIRED, see page 338	\$786	\$983	\$1140	\$1179
3-2403TR		1/2" Thermostatic Trim Plate with Handles Integrated diverter handle with independent temperature control VALVE REQUIRED, see page 338	\$786	\$983	\$1140	\$1179
3-2414TR		3/4" Thermostatic Trim Plate with Handle VALVE REQUIRED	\$831	\$1039	\$1205	\$1247
I-54°		3/4" Thermostatic Rough-in Valve	\$1020	—	—	—
3-2404TR		3/4" Thermostatic Trim Plate with Handle VALVE REQUIRED	\$831	\$1039	\$1205	\$1247
I-54°		3/4" Thermostatic Rough-in Valve	\$1020	—	—	—
3-373		Diverter/Flow Control Trim Use with stop or diverter valves, see page 347-348	\$286	\$357	\$415	\$429
3-379		Diverter/Flow Control Trim Use with stop or diverter valves, see page 347-348	\$286	\$357	\$415	\$429
3-374		Diverter/Flow Control Trim Use with stop or diverter valves, see page 347-348	\$286	\$357	\$415	\$429

AYLESBURY

			I	II	III	IV
3-378		Diverter/Flow Control Trim Use with stop or diverter valves, see page 347-348	\$286	\$357	\$415	\$429
2419		Bidet Set. Lever Handles 1/2" valves. Includes bottom spray with vacuum breaker, 4 hole mount bidet See page 330 for complete Bidet offering	\$1798	\$2247	\$2607	\$2697
34-09		Towel Ring	\$242	\$313	\$355	\$370
35-09		Towel Ring	\$264	\$330	\$383	\$396
34-01		18" Towel Bar	\$363	\$454	\$527	\$545
34-02		24" Towel Bar	\$387	\$484	\$562	\$581
35-01		18" Towel Bar	\$363	\$454	\$527	\$545
35-02		24" Towel Bar	\$387	\$484	\$562	\$581
34-12		Single Robe Hook	\$198	\$247	\$287	\$296
35-12		Single Robe Hook	\$198	\$247	\$287	\$296

AYLESBURY

			I	II	III	IV
34-13		Double Robe Hook	\$234	\$292	\$339	\$350
35-13		Double Robe Hook	\$234	\$292	\$339	\$350
34-27		Open Toilet Tissue Holder	\$238	\$298	\$345	\$357
35-27		Open Toilet Tissue Holder	\$238	\$298	\$345	\$357
34-28		Double Post Toilet Tissue Holder	\$342	\$427	\$495	\$512
35-28		Double Post Toilet Tissue Holder	\$342	\$427	\$495	\$512
2-645		Tank Lever for Aylesbury Series	\$177	\$221	\$257	\$265
6-505		Tank Lever Mechanism	\$139	\$174	\$201	\$208

Coordinating Grab Bars starting on page 358

CHESTERFIELD











CHESTERFIELD

		I	II	III	IV	
930L		Widespread Lavatory Faucet with Lever Handles 1/2" valves. Spout reach 6.96". 8" centers	\$1357	\$1697	\$1968	\$2036
						
1030		Widespread Lavatory Faucet with Lever Handles 1/2" valves. Spout reach 6.96". 8" centers.	\$1357	\$1697	\$1968	\$2036
						
930		Widespread Lavatory Faucet with Cross Handles 1/2" valves. Spout reach 6.96". 8" centers	\$1357	\$1697	\$1968	\$2036
						
1000		Widespread Lavatory Faucet with Cross Handles 1/2" valves Spout reach 6.96". 8" centers	\$1357	\$1697	\$1968	\$2036
						
1030B		Lavatory Bridge Faucet with Lever Handles 1/2" valves. Swivel Spout Leg 8" and 9.62" max Spout reach 5.33" and 7.21" max	\$2143	\$2679	\$3108	\$3215
						
930B		Lavatory Bridge Faucet with Cross Handles 1/2" valves. Swivel Spout Leg 8" and 9.62" max Spout reach 5.33" and 7.21" max.	\$1786	\$2233	\$2590	\$2679
						
1000B		Lavatory Bridge Faucet with Cross Handles 1/2" valves. Swivel Spout. Leg 8" and 9.62" max Spout reach 5.33" and 7.21" max	\$1786	\$2233	\$2590	\$2679
						

CHESTERFIELD

		I	II	III	IV
1033	 <p>Single Hole Lavatory Faucet 4.29" spout height at outlet 6.23" spout reach 9.45" overall height Includes pop-up assembly</p> 	\$1168	\$1489	\$1745	\$1752
101	 <p>Cover Plate 6" x 2-1/2"</p>	\$120	\$157	\$174	\$180
932	 <p>Single Hole Lavatory Faucet Cross Handles 5.23" spout height at outlet 6.95" spout reach 7.97" overall height Includes 325 pop-up assembly</p> 	\$1038	\$1380	\$1660	\$1710
3-930IL	 <p>Wall Mount Lavatory Faucet Lever Handles Spout reach 7.25". 8" Centers Drain not included See Fittings #330, 3301, 3302 or 3303</p> <p>VALVE REQUIRED</p> 	\$944	\$1227	\$1472	\$1472
1-532U	<p>2-valve rough with 1/2" NPT inlets & outlet</p>	\$477	—	—	—
3-944L	 <p>Wall Mount Lavatory Faucet Lever Handles Spout reach 9.78". 8" centers Drain not included See Fittings #330, 3301, 3302 or 3303</p> <p>VALVE REQUIRED</p> 	\$944	\$1227	\$1472	\$1550
1-532U	<p>2-valve rough with 1/2" NPT inlets & outlet</p>	\$477	—	—	—
3-1031	 <p>Wall Mount Lavatory Faucet Lever Handles Spout reach 7.25". 8" centers Drain not included See Fittings #330, 3301, 3302 or 3303</p> <p>VALVE REQUIRED</p> 	\$944	\$1227	\$1472	\$1472
1-532U	<p>2-valve rough with 1/2" NPT inlets & outlet</p>	\$477	—	—	—











CHESTERFIELD

		I	II	III	IV
3-930I	 <p>Wall Mount Lavatory Faucet Cross Handles Spout reach 7.25". 8" Centers Drain not included See Fittings #330, 330I, 3302 or 3303</p> <p>VALVE REQUIRED</p> 	\$944	\$1227	\$1472	\$1472
I-532U	2-valve rough with 1/2" NPT inlets & outlet	\$477	—	—	—
3-944	 <p>Wall Mount Lavatory Faucet Cross Handles. Spout reach 9.78". 8" centers Drain not included See Fittings #330, 330I, 3302 or 3303</p> <p>VALVE REQUIRED</p> 	\$944	\$1227	\$1472	\$1472
I-532U	2-valve rough with 1/2" NPT inlets & outlet	\$477	—	—	—
3-947	 <p>Wall Mount Lavatory Faucet Cross Handles. Spout reach 9.78". 8" centers Drain not included. See Fittings #330, 330I, 3302 or 3303</p> <p>VALVE REQUIRED</p> 	\$944	\$1189	\$1369	\$1416
I-532U	2-valve rough with 1/2" NPT inlets & outlet	\$477	—	—	—
3-1003	 <p>Wall Mount Lavatory Faucet Cross Handles. Spout reach 7.25". 8" centers Drain not included. See Fittings #330, 330I, 3302 or 3303</p> <p>VALVE REQUIRED</p> 	\$944	\$1189	\$1369	\$1416
I-532U	2-valve rough with 1/2" NPT inlets & outlet	\$477	—	—	—
3-1036	 <p>Roman Tub Faucet Lever Handles. Spout reach 11.53"</p> <p>VALVE REQUIRED</p>	\$1246	\$1558	\$1807	\$1869
I-502	3/4" valve for above, quick connect included	\$564	—	—	—

CHESTERFIELD

			I	II	III	IV
3-1006		Roman Tub Faucet Cross Handles. Spout reach 11.52"	\$1520	\$1900	\$2204	\$2280
		VALVE REQUIRED				
I-502		3/4" valve for above, quick connect included	\$564	—	—	—
3-936		Roman Tub Faucet Cross Handles. Spout reach 11.53"	\$1520	\$1900	\$2204	\$2280
		VALVE REQUIRED				
I-502		3/4" valve for above, quick connect included	\$564	—	—	—
3-1037		Roman Tub Faucet with Hand Shower Lever Handles. Spout reach 11.53"	\$1820	\$2275	\$2639	\$2730
		VALVE REQUIRED				
						
I-503		3/4" valve for above. Includes hose and quick connect	\$1134	—	—	—
3-937		Roman Tub Faucet with Hand Shower Cross Handles. Spout reach 11.53"	\$1820	\$2275	\$2639	\$2730
		VALVE REQUIRED				
						
I-503		3/4" valve for above. Includes hose and quick connect	\$1134	—	—	—
3-1007		Roman Tub Faucet with Hand Shower Cross Handles. Spout reach 11.52"	\$1820	\$2275	\$2639	\$2730
		VALVE REQUIRED				
						
I-503		3/4" valve for above. Includes hose and quick connect	\$1134	—	—	—
3-925		Wall Mount Tub Faucet Cross Handles	\$1090	\$1363	\$1581	\$1635
		VALVE REQUIRED				
I-500U		2-valve rough with 1/2" NPT inlets & outlet	\$477	—	—	—















CHESTERFIELD

			I	II	III	IV
933		Exposed Tub & Hand Shower Set Deck Mount 7.25" centers. Spout reach 9.11" Includes: 281 Hand Shower	\$1822	\$2340	\$2804	\$2945
						
1013		Exposed Tub & Hand Shower Set Deck mounted. 7.25" centers Spout reach 9.11" Includes: 281 Hand Shower Floor Mount Kit item 3-196 or 3-226 sold separately	\$1822	\$2340	\$2804	\$2945
						
934		Exposed Tub & Hand Shower Set Wall Mount 6" centers. Spout reach 7" Includes: 281 Hand Shower Floor-mount kit item 3-196 or 3-226 sold separately	\$1736	\$2227	\$2674	\$2808
						
I-378		Required Rough for Exposed Tub Filler For use with 3-196 or 3-226 tub risers	\$549	—	—	—
1014		Exposed Tub & Hand Shower Set Wall mounted. 6" centers Spout reach 7" Includes: 281 Hand Shower Floor Mount Kit item 3-196 or 3-226 sold separately	\$1736	\$2227	\$2674	\$2808
						
I-378		Required Rough for Exposed Tub Filler For use with 3-196 or 3-226 tub risers	\$549	—	—	—
3-196		Floor Mount Kit for Exposed Tub Sets Set includes: 2 each Floor Flanges 2 each 3/4" Risers - 31" high Decorative Stabilizer Kit sold separately	\$767	\$980	\$1175	\$1175
3-226		Same as above only 24" high	\$736	\$944	\$1135	\$1135
3-192		3/4" Shut-off Valves for above (1 pair hot & cold)	\$1077	\$1347	\$1562	\$1616
2-734		Decorative Stabilizer Kit for Exposed Tub Floor Riser Kits Adjustable for risers that are 6" to 9" apart Includes 1-1/2" finished ring for connecting kit to tub overflow pipe. Finished plate for wall mounting up to 10" center of riser pipes	\$378	\$472	\$547	\$566
		Wall Mount Plate				

CHESTERFIELD

		I	II	III	IV	
930-4261		Free Standing Tub Filler 35.95" (91.3cm) spout height at outlet (from floor) 8.72" (22.2cm) spout reach 41.93" overall height 12 gallons (45.2 liters) per minute maximum flow rate (spout) 9.25 gallons (35 liters) per minute maximum flow rate (spout) 1.8 gallons (6.8 liters) per minute maximum flow rate (hand shower)	\$2862	\$3578	\$4150	\$4293
						
I-339	SEE PAGE 304	Rough for Freestanding Tub Filler For subfloor and concrete floor installations 4.53" overall height 7.20" overall base diameter Universal 3/4" NPT and 1/2" direct sweat connections Test caps included	\$434	—	—	—
2-144		Tub Spout 1/2" NPT inlet fitting 7.56" spout length	\$277	\$347	\$402	\$416
4-1034BP		Balanced Pressure Shower Trim with Lever Handle Less showerhead, shower arm	\$704	\$880	\$1021	\$1056
I-684		VALVE REQUIRED Newport Brass Balanced Pressure Valve, 3 port with service stops, universal 1/2" NPT & direct sweat connections See Shower & Drain Sections to complete shower	\$365	—	—	—
4-924BP		Balanced Pressure Shower Set. Cross Handle Less showerhead, shower arm	\$704	\$880	\$1021	\$1056
I-684		VALVE REQUIRED Newport Brass Balanced Pressure Valve, 3 port with service stops, universal 1/2" NPT & direct sweat connections See Shower & Drain Sections to complete shower	\$365	—	—	—
4-1004BP		Balanced Pressure Shower Trim with Cross Handle Less showerhead, shower arm	\$704	\$880	\$1021	\$1056
I-684		VALVE REQUIRED Newport Brass Balanced Pressure Valve, 3 port with service stops, universal 1/2" NPT & direct sweat connections See Shower & Drain Sections to complete shower	\$365	—	—	—
5-1032BP		Balanced Pressure Tub & Shower Trim with Lever Handle Less tub spout, showerhead, shower arm	\$794	\$993	\$1152	\$1191
I-685		VALVE REQUIRED Newport Brass Balanced Pressure Valve with diverter, 4 port with service stops, universal 1/2" NPT & direct sweat connections See Shower & Drain Sections to complete shower	\$503	—	—	—







CHESTERFIELD

			I	II	III	IV
5-922BP		Balanced Pressure Tub & Shower Trim with Cross Handle Less tub spout, showerhead, shower arm	\$794	\$993	\$1152	\$1191
		VALVE REQUIRED				
						
1-685		Newport Brass Balanced Pressure Valve with diverter, 4 port with service stops, universal 1/2" NPT & direct sweat connections	\$503	—	—	—
		See Shower & Drain Sections to complete shower				
5-1002BP		Balanced Pressure Tub & Shower Trim with Cross Handle Less tub spout, showerhead, shower arm	\$794	\$993	\$1152	\$1191
		VALVE REQUIRED				
1-685		Newport Brass Balanced Pressure Valve with diverter, 4 port with service stops, universal 1/2" NPT & direct sweat connections	\$503	—	—	—
		See Shower & Drain Sections to complete shower				
3-1034BP		Balanced Pressure Shower Set. Lever Handle	\$863	\$1079	\$1252	\$1295
		VALVE REQUIRED				
1-684		Newport Brass Balanced Pressure Valve, 3 port with service stops, universal 1/2" NPT & direct sweat connections	\$365	—	—	—
3-924BP		Balanced Pressure Shower Set. Cross Handle	\$863	\$1079	\$1252	\$1295
		VALVE REQUIRED				
1-684		Newport Brass Balanced Pressure Valve, 3 port with service stops, universal 1/2" NPT & direct sweat connections	\$365	—	—	—
3-1032BP		Balanced Pressure Tub & Shower Set. Lever Handle	\$1142	\$1428	\$1656	\$1713
		VALVE REQUIRED				
1-685		Newport Brass Balanced Pressure Valve with diverter, 4 port with service stops, universal 1/2" NPT & direct sweat connections	\$503	—	—	—
						
3-922BP		Balanced Pressure Tub & Shower Set. Cross Handle.	\$1142	\$1428	\$1656	\$1713
		VALVE REQUIRED				
1-685		Newport Brass Balanced Pressure Valve with diverter, 4 port with service stops, universal 1/2" NPT & direct sweat connections	\$503	—	—	—
						
						





CHESTERFIELD

		I	II	III	IV	
3-923TR		1/2" Thermostatic Trim Plate with Handles Integrated diverter handle with independent temperature control VALVE REQUIRED, see page 338	\$786	\$983	\$1140	\$1179
3-1003TR		1/2" Thermostatic Trim Plate with Handles Integrated diverter handle with independent temperature control VALVE REQUIRED, see page 338	\$786	\$983	\$1140	\$1179
3-923TS		1/2" Thermostatic Trim Plate with Handles Integrated diverter handle with independent temperature control VALVE REQUIRED, see page 338	\$786	\$983	\$1140	\$1179
3-1003TS		1/2" Thermostatic Trim Plate with Handles Integrated diverter handle with independent temperature control VALVE REQUIRED, see page 338	\$786	\$983	\$1140	\$1179
3-1034TR		3/4" Thermostatic Trim Plate with Handle VALVE REQUIRED	\$639	\$799	\$927	\$959
I-540		3/4" Thermostatic Rough-in Valve	\$1020	—	—	—
3-924TR		3/4" Thermostatic Trim Plate with Handle VALVE REQUIRED	\$639	\$799	\$927	\$959
I-540		3/4" Thermostatic Rough-in Valve	\$1020	—	—	—
3-1004TR		3/4" Thermostatic Trim Plate with Handle VALVE REQUIRED	\$639	\$799	\$927	\$959
I-540		3/4" Thermostatic Rough-in Valve	\$1020	—	—	—

CHESTERFIELD

			I	II	III	IV
3-241		Diverter/Flow Control Handle Trim with Arrow Insert	\$253	\$324	\$390	\$390
3-241B		Diverter/Flow Control Handle Trim with Plain Insert Use with stop or diverter valves, see page 347-348	\$253	\$324	\$390	\$390
3-163		Diverter/Flow Control Trim with Arrow insert	\$302	\$378	\$438	\$453
3-163B		Diverter/Flow Control Trim with Plain insert Use with stop or diverter valves, see page 347-348	\$276	\$345	\$401	\$414
3-230		Diverter/Flow Control Trim, Arrow	\$253	\$324	\$390	\$390
3-230B		Diverter/Flow Control Trim, Plain Insert NOTE: HOT & COLD HANDLE BUTTONS ARE IN FRENCH Use with stop or diverter valves, see page 347-348	\$253	\$324	\$390	\$390
929		Bidet Set Cross Handles. 1/2" valves Includes bottom spray with vacuum breaker 4 hole mount bidet See page 330 for complete Bidet offering	\$1907	—	—	\$3025
890-1410		Towel Ring	\$197	\$246	\$285	\$295
890-1400		Towel Ring - Open	\$246	\$307	\$356	\$368
890-1230		18" Towel Bar	\$264	\$330	\$383	\$396
890-1250		24" Towel Bar	\$309	\$387	\$449	\$464

CHESTERFIELD

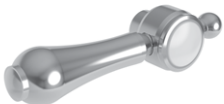
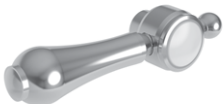
		I	II	III	IV
890-1650	 Single Robe Hook	\$87	\$108	\$125	\$130
890-1660	 Double Robe Hook	\$176	\$220	\$255	\$264
890-1510	 Hanging Toilet Tissue Holder	\$246	\$307	\$356	\$368
890-1500	 Double Post Toilet Tissue Holder	\$289	\$362	\$420	\$434
2-136	 Tank Lever for Chesterfield Series	\$171	\$213	\$247	\$256
6-505	 Tank Lever Mechanism	\$139	\$174	\$201	\$208

Coordinating Grab Bars starting on page 358



Chesterfield Single Hole Lavatory Faucet in Oil Rubbed Bronze (10B) (see page 138)











CLEMENS



CLEMENS

			I	II	III	IV
3250		Widespread Lavatory Faucet Lever Handles 1/2" valves. Spout reach 6.13" 8" centers	\$1500	\$1875	\$2175	\$2250
						
3250C		Widespread Lavatory Faucet Lever Handles 1/2" valves. Spout reach 5.67" 8" centers	\$1500	\$1875	\$2175	\$2250
						
3260		Widespread Lavatory Faucet Cross Handles 1/2" valves. Spout reach 6.13" 8" centers	\$1500	\$1875	\$2175	\$2250
						
3260C		Widespread Lavatory Faucet Cross Handles 1/2" valves. Spout reach 5.67" 8" centers	\$1500	\$1875	\$2175	\$2250
						
3-325I		Wall Mount Lavatory Faucet Lever Handles. Spout reach 8.25" 8" centers. Drain not included See Fittings #330, 3301, 3302 or 3303	\$1163	\$1454	\$1687	\$1730
		VALVE REQUIRED				
						
I-532U		2-valve rough with 1/2" NPT inlets & outlet	\$477	—	—	—
3-326I		Wall Mount Lavatory Faucet Cross Handles. Spout reach 8.25" 8" centers. Drain not included See Fittings #330, 3301, 3302 or 3303	\$1163	\$1454	\$1687	\$1730
		VALVE REQUIRED				
						
I-532U		2-valve rough with 1/2" NPT inlets & outlet	\$477	—	—	—
3-642		Tub Spout 1/2" NPT inlet fitting 8.82" spout length	\$436	\$545	\$633	\$654







CLEMENS

			I	II	III	IV
3-3256		Roman Tub Faucet Lever Handles. Spout reach 8.25"	\$1836	\$2295	\$2663	\$2754
		VALVE REQUIRED				
1-697		3/4" Valve for above. Quick connect included	\$564	—	—	—
3-3257		Roman Tub Faucet with Hand Shower Lever Handles. Spout reach 8.25"	\$2136	\$2670	\$3098	\$3204
		VALVE REQUIRED				
1-698		3/4" valve for above. Includes hose and quick connect	\$1134			
3-3255		Wall Mount Tub Faucet with Lever Handles	\$1090	\$1386	\$1607	\$1635
		VALVE REQUIRED				
1-500U		2-valve rough with 1/2" NPT inlets & outlet	\$477	—	—	—
4-3254BP		Balanced Pressure Shower Trim with Lever Handle Less showerhead, shower arm	\$744	\$1039	\$1187	\$1187
		VALVE REQUIRED				
1-684		Newport Brass Balanced Pressure Valve, 3 port with service stops, universal 1/2" NPT & direct sweat connections	\$365	—	—	—
		See Shower & Drain Sections to complete shower				
4-3264BP		Balanced Pressure Shower Trim with Cross Handle Less showerhead, shower arm	\$744	\$1039	\$1187	\$1187
		VALVE REQUIRED				
1-684		Newport Brass Balanced Pressure Valve, 3 port with service stops, universal 1/2" NPT & direct sweat connections	\$365	—	—	—
		See Shower & Drain Sections to complete shower				
5-3252BP		Balanced Pressure Tub & Shower Trim with Lever Handle Less tub spout, showerhead, shower arm	\$894	\$1171	\$1314	\$1341
		VALVE REQUIRED				
1-685		Newport Brass Balanced Pressure Valve with diverter, 4 port with service stops, universal 1/2" NPT & direct sweat connections	\$503	—	—	—
		See Shower & Drain Sections to complete shower				
5-3262BP		Balanced Pressure Tub & Shower Trim with Cross Handle. Less tub spout, showerhead, shower arm	\$894	\$1171	\$1314	\$1341
		VALVE REQUIRED				
1-685		Newport Brass Balanced Pressure Valve with diverter, 4 port with service stops, universal 1/2" NPT & direct sweat connections	\$503	—	—	—
		See Shower & Drain Sections to complete shower				

CLEMENS

			I	II	III	IV
3-3253TR		1/2" Thermostatic Trim Plate with Handles Integrated diverter handle with independent temperature control VALVE REQUIRED, see page 338	\$913	\$1278	\$1473	\$1473
3-3263TR		1/2" Thermostatic Trim Plate with Handles Integrated diverter handle with independent temperature control VALVE REQUIRED, see page 338	\$913	\$1278	\$1473	\$1473
3-3254TR		3/4" Thermostatic Trim Plate with Handle VALVE REQUIRED	\$979	\$1224	\$1432	\$1469
I-54°		3/4" Thermostatic Rough-in Valve	\$1020	—	—	—
3-3264TR		3/4" Thermostatic Trim Plate with Handle VALVE REQUIRED	\$979	\$1224	\$1432	\$1469
I-54°		3/4" Thermostatic Rough-in Valve	\$1020	—	—	—
3-646		Diverter/Flow Control Trim Use with stop or diverter valves, see page 347-348	\$290	\$373	\$465	\$465
3-647		Diverter/Flow Control Trim Use with stop or diverter valves, see page 347-348	\$290	\$373	\$465	\$465
3250-I410		Towel Ring	\$289	\$362	\$419	\$434

CLEMENS

			I	II	III	IV
3250-1230		18" Towel Bar	\$379	\$473	\$549	\$568
3250-1250		24" Towel Bar	\$421	\$526	\$611	\$632
3250-1650		Single Robe Hook	\$236	\$295	\$365	\$365
3250-1660		Double Robe Hook	\$268	\$334	\$393	\$401
3250-1510		Hanging Toilet Tissue Holder	\$286	\$357	\$415	\$429
3250-1530		Double Post Toilet Tissue Holder	\$393	\$491	\$569	\$589

Coordinating Grab Bars starting on page 358



Clemens Widespread Lavatory Faucet in Satin Nickel (15S) (see page 150)



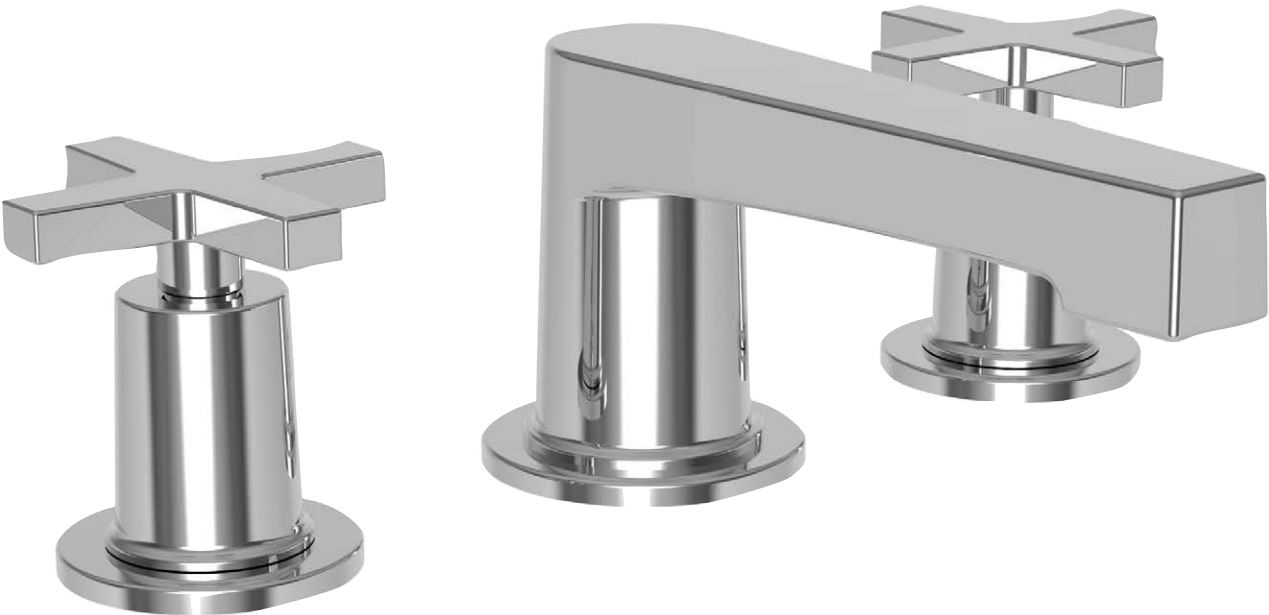



DORRANCE









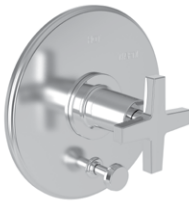

DORRANCE

		I	II	III	IV
2970	 <p>Widespread Lavatory Faucet Lever Handles 1/2" valves. Spout reach 5.53" 8" centers.</p> 	\$1357	\$1732	\$1968	\$2036
2980	 <p>Widespread Lavatory Faucet Cross Handles 1/2" valves. Spout reach 5.53" 8" centers</p> 	\$1357	\$1732	\$1968	\$2036
3-2971	 <p>Wall Mount Lavatory Faucet Lever Handles. Spout reach 7.11" 8" centers. Drain not included See Fittings #330, 3301, 3302 or 3303</p> <p>VALVE REQUIRED</p> 	\$1163	\$2018	\$2319	\$2410
I-532U	2-valve rough with 1/2" NPT inlets & outlet	\$477	—	—	—
3-2981	 <p>Wall Mount Lavatory Faucet Cross Handles. Spout reach 7.11" 8" centers. Drain not included See Fittings #330, 3301, 3302 or 3303</p> <p>VALVE REQUIRED</p> 	\$1163	\$2018	\$2319	\$2410
I-532U	2-valve rough with 1/2" NPT inlets & outlet	\$477	—	—	—
3-234	 <p>Tub Spout t 1/2" NPT inlet fitting 7" spout length</p>	\$274	\$342	\$397	\$411
3-2976	 <p>Roman Tub Faucet Lever Handles. Spout reach 7.88"</p> <p>VALVE REQUIRED</p>	\$1836	\$2295	\$2663	\$2754
I-665	3/4" valve for above Quick connect included	\$564	—	—	—
3-2977	 <p>Roman Tub Faucet with Hand Shower Lever Handles. Spout reach 7.88"</p> <p>VALVE REQUIRED</p> 	\$2136	\$2670	\$3098	\$3204
I-666	3/4" valve for above Includes hose & quick connect	\$1134	—	—	—

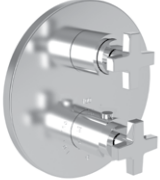



DORRANCE

			I	II	III	IV
3-2975		Wall Mount Tub Faucet with Lever Handles VALVE REQUIRED	\$1070	\$1337	\$1551	\$1604
I-500U		2-valve rough with 1/2" NPT inlets & outlet	\$477	—	—	—
3-2985		Wall Mount Tub Faucet with Cross Handles VALVE REQUIRED	\$1090	\$1363	\$1581	\$1635
I-500U		2-valve rough with 1/2" NPT inlets & outlet	\$477	—	—	—
4-2974BP		Balanced Pressure Shower Trim with Lever Handle Less showerhead, shower arm VALVE REQUIRED	\$829	\$1080	\$1245	\$1245
I-684		Newport Brass Balanced Pressure Valve, 3 port with service stops, universal 1/2" NPT & direct sweat connections See Shower & Drain Sections to complete shower.	\$365	—	—	—
4-2984BP		Balanced Pressure Shower Trim with Cross Handle Less showerhead, shower arm VALVE REQUIRED	\$829	\$1080	\$1245	\$1245
I-684		Newport Brass Balanced Pressure Valve, 3 port with service stops, universal 1/2" NPT & direct sweat connections See Shower & Drain Sections to complete shower.	\$365	—	—	—
5-2972BP		Balanced Pressure Tub & Shower Trim with Lever Handle Less tub spout, showerhead, shower arm VALVE REQUIRED	\$889	\$1113	\$1290	\$1334
I-685		Newport Brass Balanced Pressure Valve with diverter, 4 port with service stops, universal 1/2" NPT & direct sweat connections See Shower & Drain Sections to complete shower	\$503	—	—	—
5-2982BP		Balanced Pressure Tub & Shower Trim with Cross Handle Less tub spout, showerhead, shower arm VALVE REQUIRED	\$889	\$1113	\$1290	\$1334
I-685		Newport Brass Balanced Pressure Valve with diverter, 4 port with service stops, universal 1/2" NPT & direct sweat connections See Shower & Drain Sections to complete shower	\$503	—	—	—

DORRANCE

			I	II	III	IV
3-2974BP		Balanced Pressure Shower Set. Lever Handle VALVE REQUIRED	\$1279	\$1721	\$1988	\$2050
I-684		Newport Brass Balanced Pressure Valve, 3 port with service stops, universal 1/2" NPT & direct sweat connections	\$365	—	—	—
3-2973TR		1/2" Thermostatic Trim Plate with Handles Integrated diverter handle with independent temperature control VALVE REQUIRED, see page 338	\$913	\$1206	\$1386	\$1450
3-2983TR		1/2" Thermostatic Trim Plate with Handles Integrated diverter handle with independent temperature control VALVE REQUIRED, see page 338	\$913	\$1206	\$1386	\$1450
3-2974TR		3/4" Thermostatic Trim Plate with Handle VALVE REQUIRED	\$979	\$1273	\$1440	\$1469
I-540		3/4" Thermostatic Rough-in Valve	\$1020	—	—	—
3-2984TR		3/4" Thermostatic Trim Plate with Handle VALVE REQUIRED	\$979	\$1273	\$1440	\$1469
I-540		3/4" Thermostatic Rough-in Valve	\$1020	—	—	—
3-575		Diverter/Flow Control Trim Use with stop or diverter valves, see page 347-348	\$275	\$344	\$399	\$413
3-573		Diverter/Flow Control Trim Use with stop or diverter valves, see page 347-348	\$275	\$344	\$399	\$413

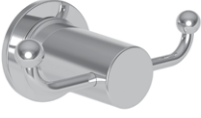
DORRANCE

			I	II	III	IV
42-09		Towel Ring	\$297	\$371	\$430	\$445
42-01		18" Towel Bar	\$411	\$514	\$596	\$617
42-02		24" Towel Bar	\$434	\$543	\$630	\$651
42-12		Single Robe Hook	\$172	\$214	\$249	\$257
42-13		Double Robe Hook	\$211	\$263	\$306	\$316
42-27		Hanging Toilet Tissue Holder	\$300	\$375	\$435	\$450
42-28		Double Post Toilet Tissue Holder	\$354	\$442	\$513	\$530

Coordinating Grab Bars starting on page 358



Griffey Single Hole Lavatory Faucet in Satin Bronze (10) | AD BEST DESIGN AWARD WINNER (see page 176)

EAST LINEAR



EAST LINEAR

			I	II	III	IV
990LS		Widespread Lavatory Faucet Lever Handles 1/2" valves. Spout reach 6.25" 10.11" Total Height	\$1357	\$1697	\$1968	\$2036
990L		Widespread Lavatory Faucet Lever Handles 1/2" valves. Spout reach 7.13" 8" centers	\$1357	\$1697	\$1968	\$2036
1500		Widespread Lavatory Faucet Lever Handles 1/2" valves. Spout reach 7.13" 8" centers	\$1357	\$1697	\$1968	\$2036
1400L		Widespread Lavatory Faucet Lever Handles 1/2" valves. Spout reach 6.13" 8" centers	\$1357	\$1697	\$1968	\$2036
990S		Widespread Lavatory Faucet Cross Handles 1/2" valves. Spout reach 6.25" 10.11" Total Height	\$1357	\$1697	\$1968	\$2036
990		Widespread Lavatory Faucet Cross Handles 1/2" valves. Spout reach 7.13" 8" centers	\$1357	\$1697	\$1968	\$2036
1400		Widespread Lavatory Faucet Cross handles 1/2" valves. Spout reach 6.13" 8" centers	\$1357	\$1697	\$1968	\$2036

BATH

EAST LINEAR

		I	II	III	IV
2930	 <p>Widespread Lavatory Faucet 1/2" valves. Spout reach 6.01" 8" centers</p> 	\$1286	\$1608	\$1865	\$1929
2960	 <p>Widespread Lavatory Faucet 1/2" valves. Spout reach 6.13" 8" centers</p> 	\$1321	\$1951	\$2249	\$2362
2920	 <p>Widespread Lavatory Faucet 1/2" valves. Spout reach 7.13" 8" centers</p> 	\$1436	\$2099	\$2391	\$2510
2950	 <p>Widespread Lavatory Faucet 1/2" valves. Spout reach 6.13" 8" centers</p> 	\$1436	\$2099	\$2391	\$2511
I503	 <p>Single Hole Lavatory Faucet 2.59" spout height at outlet 4.03" spout reach 8.49" overall height Includes pop-up assembly</p> 	\$1168	\$1460	\$1694	\$1752
I01	 <p>Cover Plate 6" x 2-1/2".</p>	\$120	\$157	\$174	\$180
I503-I	 <p>Single Hole Lavatory Faucet 3.60" spout height at outlet 5.62" spout reach 9.02" overall height Includes pop-up assembly</p> 	\$1168	\$1489	\$1745	\$1752
I01	 <p>Cover Plate 6" x 2-1/2".</p>	\$120	\$157	\$174	\$180







EAST LINEAR

			I	II	III	IV
1508		Single Hole Vessel Faucet 7.92" (20.1cm) spout height at outlet 4.03" (10.2cm) spout reach Drains not included For lavatory sink drains, see Fittings # 330, 3301, 3302, or 3303	\$1408	\$1760	\$2042	\$2112
						
101		Cover Plate 6" x 2-1/2".	\$120	\$157	\$174	\$180
3-99IL		Wall Mount Lavatory Faucet Lever Handles. Spout reach 9.50". 8" centers Drain not included See Fittings # 330, 3301, 3302 or 3303	\$944	\$1180	\$1369	\$1416
		VALVE REQUIRED				
I-532U		2-valve rough with 1/2" NPT inlets & outlet	\$477	—	—	—
3-150I		Wall Mount Lavatory Faucet Lever Handles. Spout reach 9.50". 8" center Drain not included See Fittings # 330, 3301, 3302 or 3303	\$944	\$1180	\$1369	\$1416
		VALVE REQUIRED				
I-532U		2-valve rough with 1/2" NPT inlets & outlet	\$477	—	—	—
3-99I		Wall Mount Lavatory Faucet Cross Handles. Spout reach 9.50". 8" centers Drain not included See Fittings # 330, 3301, 3302 or 3303	\$944	\$1180	\$1369	\$1416
		VALVE REQUIRED				
I-532U		2-valve rough with 1/2" NPT inlets & outlet	\$477	—	—	—
3-292I		Wall Mount Lavatory Faucet Spout reach 9.50". 8" center Drain not included See Fittings # 330, 3301, 3302 or 3303	\$1163	\$1454	\$1687	\$1745
		VALVE REQUIRED				
I-532U		2-valve rough with 1/2" NPT inlets & outlet	\$477	—	—	—







EAST LINEAR

			I	II	III	IV
3-996L		Roman Tub Faucet Lever Handles. Spout reach 7.88"	\$1520	\$1900	\$2204	\$2280
I-502		VALVE REQUIRED 3/4" valve for above, quick connect included	\$564	—	—	—
3-1406L		Roman Tub Faucet Lever Handles. Spout reach 8.25"	\$1520	\$1900	\$2204	\$2280
I-502		VALVE REQUIRED 3/4" valve for above, quick connect included	\$564	—	—	—
3-996		Roman Tub Faucet Cross Handles. Spout reach 7.88"	\$1520	\$1900	\$2204	\$2280
I-502		VALVE REQUIRED 3/4" valve for above, quick connect included	\$564	—	—	—
3-997L		Roman Tub Faucet with Hand Shower Lever Handles. Spout reach 7.88"	\$1820	\$2275	\$2639	\$2730
I-503		VALVE REQUIRED 3/4" valve for above. Includes hose and quick connect	\$1134	—	—	—
3-1407L		Roman Tub Faucet with Hand Shower Lever Handles. Spout reach 8.25"	\$1820	\$2275	\$2639	\$2730
I-503		VALVE REQUIRED 3/4" valve for above. Includes hose and quick connect	\$1134	—	—	—
3-997		Roman Tub Faucet with Hand Shower Cross Handles. Spout reach 7.88"	\$1820	\$2275	\$2639	\$2730
I-503		VALVE REQUIRED 3/4" valve for above. Includes hose and quick connect	\$1134	—	—	—





EAST LINEAR

			I	II	III	IV
3-1505		Wall Mount Tub Faucet Lever Handles	\$1090	\$1363	\$1581	\$1635
		VALVE REQUIRED				
1-500U		2-valve rough with 1/2" NPT inlets & outlet	\$477	—	—	—
3-995L		Wall Mount Tub Faucet Lever Handles	\$1090	\$1363	\$1581	\$1635
		VALVE REQUIRED				
1-500U		2-valve rough with 1/2" NPT inlets & outlet	\$477	—	—	—
3-995		Wall Mount Tub Faucet Cross Handles	\$1090	\$1363	\$1581	\$1635
		VALVE REQUIRED				
1-500U		2-valve rough with 1/2" NPT inlets & outlet	\$477	—	—	—
3-2925		Wall Mount Tub Faucet Spout reach 6-9/16"	\$1090	\$1366	\$1581	\$1635
		VALVE REQUIRED				
1-500U		2-valve rough with 1/2" NPT inlets & outlet	\$477	—	—	—
1500-4273		Exposed Tub and Hand Shower Set - Deck Mount Lever Handles 7.03" centers. Spout reach 9" Includes: 283-101 Hand Shower	\$2402	\$3002	\$3718	\$3830
1400-4273		Exposed Tub and Hand Shower Set - Deck Mount Lever Handles 7.03" centers. Spout reach 9" Includes: 283-101 Hand Shower	\$2402	\$3002	\$3718	\$3830
1500-4272		Exposed Tub and Hand Shower Set - Deck Mount Cross Handles 7.03" centers. Spout reach 9" Includes: 283-101 Hand Shower	\$2402	\$3002	\$3718	\$3830

EAST LINEAR











			I	II	III	IV
1400-4272		Exposed Tub and Hand Shower Set - Deck Mount Cross Handles 7.03" centers. Spout reach 9" Includes: 283-101 Hand Shower	\$2402	\$3002	\$3718	\$3830
1500-4283		Exposed Tub and Hand Shower Set - Wall Mount Lever Handles. 7.03" centers. Spout reach 9" Includes: 283-101 Hand Shower. No separate riser kit available	\$2162	\$2754	\$3497	\$3600
I-483		VALVE REQUIRED Rough for Wall Mount Exposed Tub & Hand Shower Set 1/2" NPT eccentric nipple. Test caps included	\$565	—	—	—
1500-4282		Exposed Tub and Hand Shower Set - Wall Mount Cross Handles. 7.03" centers. Spout reach 9" Includes: 283-101 Hand Shower. No separate riser kit available	\$2162	\$2754	\$3497	\$3600
I-483		VALVE REQUIRED Rough for Wall Mount Exposed Tub & Hand Shower Set 1/2" NPT eccentric nipple. Test caps included	\$565	—	—	—
1400-4282		Exposed Tub and Hand Shower Set - Wall Mount Cross Handles. 7.03" centers. Spout reach 9" Includes: 283-101 Hand Shower. No separate riser kit available	\$2162	\$2754	\$3497	\$3600
I-483		VALVE REQUIRED Rough for Wall Mount Exposed Tub & Hand Shower Set 1/2" NPT eccentric nipple. Test caps included	\$565	—	—	—
1400-4283		Exposed Tub and Hand Shower Set - Wall Mount Lever Handles. 7.03" centers. Spout reach 9" Includes: 283-101 Hand Shower. No separate riser kit available	\$2162	\$2754	\$3497	\$3600
I-483		VALVE REQUIRED Rough for Wall Mount Exposed Tub & Hand Shower Set 1/2" NPT eccentric nipple. Test caps included	\$565	—	—	—
1500-4263		Exposed Tub and Hand Shower Set with Risers Lever Handles 35.19" (89.4 cm) spout height at outlet (from floor) 9.3" (23.6 cm) spout reach 41.9" overall height 14 gallons (53 liters) per minute maximum flow rate (spout) 1.8 gallons (6.8 liters) per minute maximum flow rate (hand shower)	\$3128	\$3910	\$4535	\$4691
I-469		Required Rough for Exposed Tub Filler with Risers For subfloor or concrete floor installations 3.65" overall height 10.38" x 5" overall base size Universal 1/2" NPT connections. Test caps included For use with 1500-426X tub fillers with risers	\$705	—	—	—

EAST LINEAR

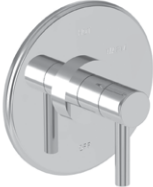
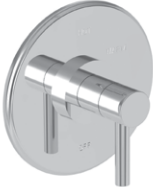





			I	II	III	IV
1400-4263		Exposed Tub and Hand Shower Set with Risers Lever Handles 35.19" (89.4 cm) spout height at outlet (from floor) 9.3" (23.6 cm) spout reach 41.9" overall height 14 gallons (53 liters) per minute maximum flow rate (spout) 1.8 gallons (6.8 liters) per minute maximum flow rate (hand shower)	\$3128	\$3910	\$4535	\$4691
1-469		Required Rough for Exposed Tub Filler with Risers For subfloor or concrete floor installations 3.65" overall height 10.38" x 5" overall base size Universal 1/2" NPT connections. Test caps included For use with 1500-426X tub fillers with risers	\$705	—	—	—
1500-4262		Exposed Tub and Hand Shower Set with Risers Cross Handles 35.19" (89.4 cm) spout height at outlet (from floor) 9.3" (23.6 cm) spout reach 41.9" overall height 14 gallons (53 liters) per minute maximum flow rate (spout) 1.8 gallons (6.8 liters) per minute maximum flow rate (hand shower)	\$3128	\$3910	\$4535	\$4691
1-469		Required Rough for Exposed Tub Filler with Risers For subfloor or concrete floor installations 3.65" overall height 10.38" x 5" overall base size Universal 1/2" NPT connections. Test caps included For use with 1500-426X tub fillers with risers	\$705	—	—	—
1400-4262		Exposed Tub and Hand Shower Set with Risers Cross Handles 35.19" (89.4 cm) spout height at outlet (from floor) 9.3" (23.6 cm) spout reach 41.9" overall height 14 gallons (53 liters) per minute maximum flow rate (spout) 1.8 gallons (6.8 liters) per minute maximum flow rate (hand shower)	\$3128	\$3910	\$4535	\$4691
1-469		Required Rough for Exposed Tub Filler with Risers For subfloor or concrete floor installations 3.65" overall height 10.38" x 5" overall base size Universal 1/2" NPT connections. Test caps included For use with 1500-426X tub fillers with risers	\$705	—	—	—
2480-4261		Free Standing Tub Filler 38.03" (96.6cm) spout height at outlet (from floor) 8.66" (22.0cm) spout reach 43" overall height 9.25 gallons (35 liters) per minute maximum flow rate (spout)	\$2862	\$3578	\$4150	\$4293
1-339	 SEE PAGE 306	Rough for Freestanding Tub Filler For subfloor and concrete floor installations 4.53" overall height 7.20" overall base diameter Universal 3/4" NPT and 1/2" direct sweat connections Test caps included	\$434	—	—	—

BATH

EAST LINEAR

		I	II	III	IV	
1400-4261		Free Standing Tub Filler 36.53" (92.7cm) spout height at outlet (from floor) 10.05" (25.5cm) spout reach 40.37" overall height 9.25 gallons (35 liters) per minute maximum flow rate (spout) 1.8 gallons (6.8 liters) per minute maximum flow rate (hand shower)	\$2862	\$3578	\$4150	\$4293
						
I-339	 <p>SEE PAGE 305</p>	Rough for Freestanding Tub Filler For subfloor and concrete floor installations 4.53" overall height 7.20" overall base diameter Universal 3/4" NPT and 1/2" direct sweat connections Test caps included	\$434	—	—	—
3-234		Tub Spout 1/2" NPT inlet fitting 7" spout length	\$274	\$342	\$397	\$411
4-1504BP		Balanced Pressure Shower Trim with Lever Handle Less showerhead, shower arm	\$704	\$880	\$1021	\$1056
I-684		VALVE REQUIRED Newport Brass Balanced Pressure Valve, 3 port with service stops, universal 1/2" NPT & direct sweat connections See Shower & Drain Sections to complete shower.	\$365	—	—	—
4-994LBP		Balanced Pressure Shower Trim with Lever Handle Less showerhead, shower arm	\$481	\$601	\$698	\$722
I-684		VALVE REQUIRED Newport Brass Balanced Pressure Valve, 3 port with service stops, universal 1/2" NPT & direct sweat connections See Shower & Drain Sections to complete shower.	\$365	—	—	—
4-994BP		Balanced Pressure Shower Trim with Cross Handle Less showerhead, shower arm	\$704	\$880	\$1021	\$1056
I-684		VALVE REQUIRED Newport Brass Balanced Pressure Valve, 3 port with service stops, universal 1/2" NPT & direct sweat connections See Shower & Drain Sections to complete shower.	\$365	—	—	—
4-2924BP		Balanced Pressure Shower Trim Less showerhead, shower arm	\$704	\$880	\$1021	\$1056
I-684		VALVE REQUIRED Newport Brass Balanced Pressure Valve, 3 port with service stops, universal 1/2" NPT & direct sweat connections See Shower & Drain Sections to complete shower.	\$365	—	—	—

EAST LINEAR

			I	II	III	IV
5-992LBP		Balanced Pressure Tub & Shower Trim with Lever Handle Less tub spout, showerhead, shower arm	\$592	\$740	\$859	\$888
I-685		VALVE REQUIRED Newport Brass Balanced Pressure Valve with diverter, 4 port with service stops, universal 1/2" NPT & direct sweat connections See Shower & Drain Sections to complete shower	\$503	—	—	—
5-992BP		Balanced Pressure Tub & Shower Trim with Cross Handle Less tub spout, showerhead, shower arm	\$794	\$993	\$1152	\$1191
I-685		VALVE REQUIRED Newport Brass Balanced Pressure Valve with diverter, 4 port with service stops, universal 1/2" NPT & direct sweat connections See Shower & Drain Sections to complete shower	\$503	—	—	—
5-2922BP		Balanced Pressure Tub & Shower Trim Less tub spout, showerhead, shower arm	\$794	\$993	\$1152	\$1191
I-685		VALVE REQUIRED Newport Brass Balanced Pressure Valve with diverter, 4 port with service stops, universal 1/2" NPT & direct sweat connections See Shower & Drain Sections to complete shower	\$503	—	—	—
3-994LBP		Balanced Pressure Shower Set. Lever Handle	\$849	\$1061	\$1230	\$1273
I-684		VALVE REQUIRED Newport Brass Balanced Pressure Valve, 3 port with service stops, universal 1/2" NPT & direct sweat connections	\$365	—	—	—
3-1504BP		Balanced Pressure Shower Set. Lever Handle	\$863	\$1079	\$1252	\$1295
I-684		VALVE REQUIRED Newport Brass Balanced Pressure Valve, 3 port with service stops, universal 1/2" NPT & direct sweat connections	\$365	—	—	—
3-994BP		Balanced Pressure Shower Set. Cross Handle	\$863	\$1079	\$1252	\$1295
I-684		VALVE REQUIRED Newport Brass Balanced Pressure Valve, 3 port with service stops, universal 1/2" NPT & direct sweat connections	\$365	—	—	—

EAST LINEAR

			I	II	III	IV
3-1502BP		Balanced Pressure Tub & Shower Set. Lever Handle VALVE REQUIRED	\$1142	\$1428	\$1656	\$1713
1-685		Newport Brass Balanced Pressure Valve with diverter, 4 port with service stops, universal 1/2" NPT & direct sweat connections	\$503	—	—	—
3-992BP		Balanced Pressure Tub & Shower Set. Cross Handle VALVE REQUIRED	\$1142	\$1428	\$1656	\$1713
1-685		Newport Brass Balanced Pressure Valve with diverter, 4 port with service stops, universal 1/2" NPT & direct sweat connections	\$503	—	—	—
3-1503TR		1/2" Thermostatic Trim Plate with Handles Integrated diverter handle with independent temperature control VALVE REQUIRED, see page 338	\$786	\$983	\$1140	\$1179
3-993TR		1/2" Thermostatic Trim Plate with Handles Integrated diverter handle with independent temperature control VALVE REQUIRED, see page 338	\$786	\$983	\$1140	\$1179
3-2923TR		1/2" Thermostatic Trim Plate with Handles Integrated diverter handle with independent temperature control VALVE REQUIRED, see page 338	\$913	\$1216	\$1396	\$1450
3-1503TS		1/2" Thermostatic Trim Plate with Handles Integrated diverter handle with independent temperature control VALVE REQUIRED, see page 338	\$786	\$983	\$1140	\$1179
3-993TS		1/2" Thermostatic Trim Plate with Handles Integrated diverter handle with independent temperature control VALVE REQUIRED, see page 338	\$786	\$983	\$1140	\$1179

EAST LINEAR

			I	II	III	IV
3-994LTR		3/4" Thermostatic Trim Plate with Handle VALVE REQUIRED	\$639	\$799	\$927	\$959
I-54°		3/4" Thermostatic Rough-in Valve	\$1020	—	—	—
3-1504TR		3/4" Thermostatic Trim Plate with Handle VALVE REQUIRED	\$639	\$799	\$927	\$959
I-54°		3/4" Thermostatic Rough-in Valve	\$1020	—	—	—
3-994TR		3/4" Thermostatic Trim Plate with Handle VALVE REQUIRED	\$639	\$799	\$927	\$959
I-54°		3/4" Thermostatic Rough-in Valve	\$1020	—	—	—
3-2924TR		3/4" Thermostatic Trim Plate with Handle VALVE REQUIRED	\$979	\$1280	\$1455	\$1469
I-54°		3/4" Thermostatic Rough-in Valve	\$1020	—	—	—
3-227LH		Diverter/Flow Control Trim. Hot. Use with stop or diverter valves, see page 347-348	\$288	\$371	\$445	\$445
3-255		Diverter/Flow Control Trim Use with stop or diverter valves, see page 347-348	\$288	\$371	\$445	\$465
3-227		Diverter/Flow Control Trim Use with stop or diverter valves, see page 347-348	\$288	\$371	\$445	\$445
3-57°		Diverter/Flow Control Trim Use with stop or diverter valves, see page 347-348	\$355	\$443	\$514	\$532

EAST LINEAR

			I	II	III	IV
999L		Bidet Set Lever Handles. 1/2" valves Includes bottom spray with vacuum breaker, 4 hole mount bidet See page 330 for complete Bidet offering	\$1925	\$2477	\$2973	\$2973
990-1200		8" Towel Bar	\$233	\$292	\$338	\$350
990-1230		18" Towel Bar	\$275	\$344	\$399	\$413
990-1250		24" Towel Bar	\$295	\$369	\$428	\$443
990-1650		Single Robe Hook	\$101	\$127	\$147	\$152
990-1660		Robe Hook	\$133	\$167	\$193	\$200
990-1570		Open Toilet Tissue Holder	\$169	\$212	\$246	\$254
990-1500		Double Post Toilet Tissue Holder	\$275	\$344	\$399	\$449
2-IIIH		Tank Lever for East Linear Series	\$233	\$297	\$361	\$375
6-505		Tank Lever Mechanism	\$139	\$174	\$201	\$208
20-289		Tank Lever for East Linear Series	\$233	\$297	\$361	\$379
6-505		Tank Lever Mechanism	\$139	\$174	\$201	\$208

Coordinating Grab Bars starting on page 358 and Baskets starting on page 354



NEW East Linear Mid-Height Lavatory Faucet in Polished Chrome (26) (see page 162)











GRIFFEY



GRIFFEY

		I	II	III	IV
3270	 <p>Widespread Lavatory Faucet Lever Handles 1/2" valves. Spout reach 6.13" 8" centers</p> 	\$1500	\$1875	\$2175	\$2250
3270c	 <p>Widespread Lavatory Faucet Lever Handles 1/2" valves. Spout reach to 5.63" 8" centers</p> 	\$1500	\$1875	\$2175	\$2250
3280	 <p>Widespread Lavatory Faucet Cross Handles 1/2" valves. Spout reach 6.13" 8" centers</p> 	\$1500	\$1875	\$2175	\$2250
3280c	 <p>Widespread Lavatory Faucet Cross Handles 1/2" valves. Spout reach to 5.63" 8" centers</p> 	\$1500	\$1875	\$2175	\$2250
3273	 <p>Single Hole Lavatory Faucet 4.10" spout height at outlet 6.19" spout reach 9.02" overall height Includes pop-up assembly</p> 	\$1168	\$1489	\$1745	\$1752
101	 <p>Cover Plate 6" x 2-1/2"</p>	\$120	\$157	\$174	\$180
3-3271	 <p>Wall Mount Lavatory Faucet Lever Handles. Spout reach 8.25" 8" centers. Drain not included See Fittings #330, 3301, 3302 or 3303</p> <p>VALVE REQUIRED</p> 	\$944	\$1320	\$1648	\$1730
I-532U	<p>2-valve rough with 1/2" NPT inlets & outlet</p>	\$477	—	—	—

GRIFFEY

		I	II	III	IV
3-3281	 <p>Wall Mount Lavatory Faucet Cross Handles. Spout reach 8.25" 8" centers. Drain not included See Fittings #330, 3301, 3302 or 3303</p> <p>VALVE REQUIRED</p> 	\$944	\$1320	\$1648	\$1730
1-532U	2-valve rough with 1/2" NPT inlets & outlet	\$477	—	—	—
3-3276	 <p>Roman Tub Faucet Lever Handles. Spout reach 8.25"</p> <p>VALVE REQUIRED</p>	\$1836	\$2295	\$2663	\$2754
1-697	3/4" Valve for above. Quick connect included	\$564	—	—	—
3-3286	 <p>Roman Tub Faucet Cross Handles. Spout reach 8.25"</p> <p>VALVE REQUIRED</p>	\$1836	\$2295	\$2663	\$2754
1-697	3/4" Valve for above. Quick connect included	\$564	—	—	—
3-3277	 <p>Roman Tub Faucet with Hand Shower Lever Handles. Spout reach 8.25"</p> <p>VALVE REQUIRED</p> 	\$2136	\$2670	\$3098	\$3204
1-698	3/4" valve for above. Includes hose and quick connect	\$1134			
3-3287	 <p>Roman Tub Faucet with Hand Shower Cross Handles. Spout reach 8.25"</p> <p>VALVE REQUIRED</p> 	\$2136	\$2670	\$3098	\$3204
1-698	3/4" valve for above. Includes hose and quick connect	\$1134			
3-3275	 <p>Wall Mount Tub Faucet with Lever Handles</p> <p>VALVE REQUIRED</p>	\$1090	\$1386	\$1607	\$1635
1-500U	 <p>2-valve rough with 1/2" NPT inlets & outlet</p>	\$477	—	—	—

GRIFFEY





			I	II	III	IV
3-3285		Wall Mount Tub Faucet with Cross Handles VALVE REQUIRED	\$1090	\$1386	\$1607	\$1635
1-500U		2-valve rough with 1/2" NPT inlets & outlet	\$477	—	—	—
3-643		Tub Spout 1/2" NPT inlet fitting 8.79" spout length	\$436	\$545	\$633	\$654
4-3274BP		Balanced Pressure Shower Trim with Lever Handle Less showerhead, shower arm VALVE REQUIRED	\$744	\$1039	\$1187	\$1187
1-684		Newport Brass Balanced Pressure Valve, 3 port with service stops, universal 1/2" NPT & direct sweat connections See Shower & Drain Sections to complete shower.	\$365	—	—	—
4-3284BP		Balanced Pressure Shower Trim with Cross Handle Less showerhead, shower arm VALVE REQUIRED	\$744	\$1039	\$1187	\$1187
1-684		Newport Brass Balanced Pressure Valve, 3 port with service stops, universal 1/2" NPT & direct sweat connections See Shower & Drain Sections to complete shower.	\$365	—	—	—
5-3272BP		Balanced Pressure Tub & Shower Trim with Lever Handle Less tub spout, showerhead, shower arm VALVE REQUIRED	\$894	\$1171	\$1314	\$1341
1-685		Newport Brass Balanced Pressure Valve with diverter, 4 port with service stops, universal 1/2" NPT & direct sweat connections See Shower & Drain Sections to complete shower	\$503	—	—	—
5-3282BP		Balanced Pressure Tub & Shower Trim with Cross Handle Less tub spout, showerhead, shower arm VALVE REQUIRED	\$894	\$1171	\$1314	\$1341
1-685		Newport Brass Balanced Pressure Valve with diverter, 4 port with service stops, universal 1/2" NPT & direct sweat connections See Shower & Drain Sections to complete shower	\$503	—	—	—

BATH

GRIFFEY

		I	II	III	IV	
3-3273TR		1/2" Thermostatic Trim Plate with Handles Integrated diverter handle with independent temperature control VALVE REQUIRED, see page 338	\$913	\$1278	\$1473	\$1473
3-3283TR		1/2" Thermostatic Trim Plate with Handles Integrated diverter handle with independent temperature control VALVE REQUIRED, see page 338	\$913	\$1278	\$1473	\$1473
3-3274TR		3/4" Thermostatic Trim Plate with Handle VALVE REQUIRED	\$979	\$1224	\$1432	\$1469
I-54O		3/4" Thermostatic Rough-in Valve	\$1020	—	—	—
3-3284TR		3/4" Thermostatic Trim Plate with Handle VALVE REQUIRED	\$979	\$1224	\$1432	\$1469
I-54O		3/4" Thermostatic Rough-in Valve	\$1020	—	—	—
3-648		Diverter/Flow Control Trim Use with stop or diverter valves, see page 347-348	\$290	\$373	\$465	\$465
3-649		Diverter/Flow Control Trim Use with stop or diverter valves, see page 347-348	\$290	\$373	\$465	\$465
3270-14IO		Towel Ring	\$289	\$362	\$419	\$434

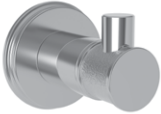
GRIFFEY

			I	II	III	IV
3270-1230		18" Towel Bar	\$379	\$473	\$549	\$568
3270-1250		24" Towel Bar	\$421	\$526	\$611	\$632
3270-1650		Single Robe Hook	\$236	\$295	\$365	\$365
3270-1660		Double Robe Hook	\$268	\$334	\$393	\$401
3270-1510		Hanging Toilet Tissue Holder	\$286	\$357	\$415	\$429
3270-1530		Double Post Toilet Tissue Holder	\$393	\$491	\$569	\$589







Coordinating Grab Bars starting on page 358









ITHACA

			I	II	III	IV
2550		Widespread Lavatory Faucet 8" centers. 1/2" valves Spout reach 6.09" 	\$1500	\$1875	\$2175	\$2250
9203		Single Hole Lavatory Faucet 4.59" (11.6cm) spout height at outlet 6.20" (15.7cm) spout reach 10.63" overall height Includes pop-up assembly Does not work with #101 cover plate 	\$1268	\$1654	\$1901	\$1902
9208		Single Hole Vessel Faucet 7.44" (18.9cm) spout height at outlet 6.20" (15.7cm) spout reach. 13.44" overall height Drain not included. For lavatory sink drains see Fittings # 330, 3301, 3302 or 3303 Does not work with #101 cover plate 	\$1408	\$1760	\$2042	\$2112
3-2551		Wall Mount Lavatory Faucet Spout reach 8.02". 8" centers Drain not included See Fittings #330, 3301, 3302 or 3303 VALVE REQUIRED 	\$964	\$1281	\$1426	\$1446
I-532U		2-valve rough with 1/2" NPT inlets & outlet	\$477	—	—	—
3-2556		Roman Tub Faucet Spout reach 9.55" VALVE REQUIRED	\$1836	\$2332	\$2663	\$2754
I-636		3/4" valve for above Quick connect included	\$564			
3-2557		Roman Tub Faucet with Hand Shower Spout reach 9.55" VALVE REQUIRED 	\$2936	\$3771	\$4258	\$4404
I-570		3/4" valve for above Includes hose and quick connect	\$1134			



ITHACA

		I	II	III	IV	
3-2555		Wall Mount Tub Faucet Spout reach 6.06"	\$1090	\$1363	\$1581	\$1635
		VALVE REQUIRED				
1-500U		2-valve rough with 1/2" NPT inlets & outlet	\$477	—	—	—
280N		Traditional Hand Shower Set Includes: No. 281-1 Traditional Multifunction Hand Shower No. 284 Braided Hose No. 285-3 Supply Elbow No. 297 Wall Coordinating Round Bracket	\$1031	\$1288	\$1494	\$1546
						
280L		Traditional 36" Slide Bar Hand Shower Kit All Brass. Includes: No. 281-1 Traditional Multifunctional Hand Shower No. 284 Braided Hose No. 285-3 Supply Elbow No. 294-1 36" Slide Bar with Adjustable Bracket	\$1580	\$1975	\$2348	\$2370
						
3-427		Tub Spout 3/4" NPT inlet fitting 6.90" spout length	\$366	\$457	\$530	\$548
4-2554BP		Balanced Pressure Shower Trim Less Showerhead, shower arm	\$780	\$1016	\$1171	\$1171
		VALVE REQUIRED				
1-684		Newport Brass Balanced Pressure Valve, 3 port with service stops, universal 1/2" NPT & direct sweat connections See Shower & Drain Sections to complete shower.	\$365	—	—	—
5-2552BP		Balanced Pressure Tub & Shower Trim Less tub spout, showerhead, shower arm	\$879	\$1144	\$1321	\$1321
		VALVE REQUIRED				
1-685		Newport Brass Balanced Pressure Valve with diverter, 4 port with service stops, universal 1/2" NPT & direct sweat connections See Shower & Drain Sections to complete shower	\$503	—	—	—

ITHACA

			I	II	III	IV
3-2554BP		Balanced Pressure Shower Set	\$1372	\$1733	\$1990	\$2058
I-684		VALVE REQUIRED Newport Brass Balanced Pressure Valve, 3 port with service stops, universal 1/2" NPT & direct sweat connections	\$365	—	—	—
3-2552BP		Balanced Pressure Tub & Shower Set	\$1687	\$2278	\$2534	\$2650
I-685		VALVE REQUIRED  Newport Brass Balanced Pressure Valve with diverter, 4 port with service stops, universal 1/2" NPT & direct sweat connections	\$503	—	—	—
3-803TR		1/2" Thermostatic Trim Plate with Handles Integrated diverter handle with independent temperature control VALVE REQUIRED, see page 338	\$786	\$983	\$1140	\$1179
3-2554TR		3/4" Thermostatic Trim Plate with Handle	\$831	\$1067	\$1190	\$1247
I-540		VALVE REQUIRED 3/4" Thermostatic Rough-in Valve	\$1020	—	—	—
3-593		Diverter/Flow Control Trim Use with stop or diverter valves, see page 347-348	\$277	\$347	\$421	\$421
38-09		Towel Ring	\$261	\$326	\$378	\$391
38-02		24" Towel Bar	\$362	\$453	\$528	\$543

ITHACA

			I	II	III	IV
38-12		Double Robe Hook	\$316	\$394	\$457	\$473
38-27		Hanging Toilet Tissue Holder	\$490	\$612	\$710	\$735
38-28		Double Post Toilet Tissue Holder	\$370	\$463	\$537	\$555

Coordinating Grab Bars starting on page 358



NEW East Linear Widespread Lavatory Faucet in Polished Nickel (15P) (See page 162)



JACOBEBAN

			I	II	III	IV
2470		Widespread Lavatory Faucet Lever Handles. 1/2" valve included Spout reach 6.05". 8" centers	\$1357	\$1697	\$1968	\$2036
						
2460		Widespread Lavatory Faucet Cross Handles. 1/2" valve included Spout reach 6.05". 8" centers	\$1357	\$1697	\$1968	\$2036
						
2473		Single Hole Lavatory Faucet 5.60" spout height at outlet 5.89" spout reach 8.10" overall height Includes pop-up assembly	\$1168	\$1460	\$1694	\$1752
						
101		Cover Plate 6" x 2-1/2".	\$120	\$157	\$174	\$180
3-2471		Wall Mount Lavatory Faucet Trim Lever Handles. Spout reach 8.22" 8" centers. Drain not included See Fittings # 330, 3301, 3302 or 3303	\$944	\$1180	\$1369	\$1416
		VALVE REQUIRED				
						
1-532U		2-valve rough with 1/2" NPT inlets & outlet	\$477	—	—	—
3-2461		Wall Mount Lavatory Faucet Cross Handles. Spout reach 8.22" 8" centers. Drain not included See Fittings # 330, 3301, 3302 or 3303	\$944	\$1180	\$1369	\$1416
		VALVE REQUIRED				
						
1-532U		2-valve rough with 1/2" NPT inlets & outlet	\$477	—	—	—
3-2476		Roman Tub Faucet with Lever Handles Spout reach 10.96"	\$1520	\$1900	\$2204	\$2280
		VALVE REQUIRED				
1-502		3/4" valve for above, quick connect included	\$564	—	—	—

JACOBEBAN

		I	II	III	IV
3-2477	 <p>Roman Tub Faucet with Hand Shower Lever Handles Spout reach 10.96"</p> <p>VALVE REQUIRED</p> 	\$1820	\$2275	\$2639	\$2730
I-503	<p>3/4" valve for above. Includes hose and quick connect</p>	\$1134	—	—	—
3-2475	 <p>Wall Mount Tub Faucet with Lever Handles</p> <p>VALVE REQUIRED</p>	\$1090	\$1363	\$1581	\$1635
I-500U	 <p>2-valve rough with 1/2" NPT inlets & outlet</p>	\$477	—	—	—
3-2465	 <p>Wall Mount Tub Faucet with Cross Handles.</p> <p>VALVE REQUIRED</p>	\$1090	\$1363	\$1581	\$1635
I-500U	 <p>2-valve rough with 1/2" NPT inlets & outlet</p>	\$477	—	—	—
2400-4273	 <p>Exposed Tub and Hand Shower Set Deck Mount Lever Handles 7.25" centers. Spout reach 9.11" Includes: 281 Hand Shower</p> 	\$2081	\$2602	\$3082	\$3122
2400-4272	 <p>Exposed Tub and Hand Shower Set Deck Mount Cross Handles 7.25" centers. Spout reach 9.11" Includes: 281 Hand Shower</p>	\$2081	\$2602	\$3082	\$3122
I-378	<p>Required Rough for Exposed Tub Filler For use with 3-196 or 3-226 tub risers</p> 	\$549	—	—	—
2400-4283	 <p>Exposed Tub and Hand Shower Set Wall Mount. Lever Handles 6" centers. Spout reach 7" Includes: 281 Hand Shower Floor-mount kit item 3-196 or 3-226 sold separately</p> 	\$2081	\$2602	\$3018	\$3122
I-378	<p>Required Rough for Exposed Tub Filler For use with 3-196 or 3-226 tub risers</p>	\$549	—	—	—







JACOBEOAN

			I	II	III	IV
2400-4282		Exposed Tub and Hand Shower Set Wall Mount Cross Handles 6" centers. Spout reach 7" Includes: 281 Hand Shower Floor-mount kit item 3-196 or 3-226 sold separately	\$2081	\$2602	\$3018	\$3122
1-378		Required Rough for Exposed Tub Filler For use with 3-196 or 3-226 tub risers	\$549	—	—	—
						
3-196		Floor Mount Kit for Exposed Tub Sets Set includes: 2 each Floor Flanges 2 each 3/4" Risers - 31" high Decorative Stabilizer Kit sold separately	\$767	\$980	\$1175	\$1175
3-226		Same as above only 24" high	\$736	\$944	\$1135	\$1135
3-192		3/4" Shut-off Valves for above (1 pair hot & cold)	\$1077	\$1347	\$1562	\$1616
2-734		Decorative Stabilizer Kit for Exposed Tub Floor Riser Kits Adjustable for risers that are 6" to 9" apart. Includes 1 1/2" finished ring for connecting kit to tub overflow pipe. Finished plate for wall mounting up to 10" center of riser pipes.	\$378	\$472	\$547	\$566
		Wall Mount Plate				
3-668		Tub Spout 1/2" NPT inlet fitting 10.32" spout length	\$296	\$370	\$429	\$444
4-2414BP		Balanced Pressure Shower Trim with Lever Handle Less showerhead, shower arm	\$780	\$975	\$1131	\$1171
1-684		VALVE REQUIRED Newport Brass Balanced Pressure Valve, 3 port with service stops, universal 1/2" NPT & direct sweat connections See Shower & Drain Sections to complete shower.	\$365	—	—	—
4-2404BP		Balanced Pressure Shower Trim with Cross Handle Less showerhead, shower arm	\$780	\$975	\$1131	\$1171
1-684		VALVE REQUIRED Newport Brass Balanced Pressure Valve, 3 port with service stops, universal 1/2" NPT & direct sweat connections See Shower & Drain Sections to complete shower.	\$365	—	—	—





JACOBEBAN

		I	II	III	IV	
5-2412BP		Balanced Pressure Tub & Shower Trim with Lever Handle Less tub spout, showerhead, shower arm	\$889	\$1112	\$1290	\$1334
		VALVE REQUIRED				
1-685		Newport Brass Balanced Pressure Valve with diverter, 4 port with service stops, universal 1/2" NPT & direct sweat connections	\$503	—	—	—
		See Shower & Drain Sections to complete shower				
5-2402BP		Balanced Pressure Tub & Shower Trim with Cross Handle Less tub spout, showerhead, shower arm	\$889	\$1112	\$1290	\$1334
		VALVE REQUIRED				
1-685		Newport Brass Balanced Pressure Valve with diverter, 4 port with service stops, universal 1/2" NPT & direct sweat connections	\$503	—	—	—
		See Shower & Drain Sections to complete shower				
3-2414BP		Balanced Pressure Shower Set. Lever Handle	\$1372	\$1715	\$1990	\$2058
		VALVE REQUIRED				
1-684		Newport Brass Balanced Pressure Valve, 3 port with service stops, universal 1/2" NPT & direct sweat connections	\$365	—	—	—
3-2404BP		Balanced Pressure Shower Set. Cross Handle	\$1372	\$1715	\$1990	\$2058
		VALVE REQUIRED				
1-684		Newport Brass Balanced Pressure Valve, 3 port with service stops, universal 1/2" NPT & direct sweat connections	\$365	—	—	—
3-2413TR		1/2" Thermostatic Trim Plate with Handles Integrated diverter handle with independent temperature control	\$786	\$983	\$1140	\$1179
		VALVE REQUIRED, see page 338				
3-2403TR		1/2" Thermostatic Trim Plate with Handles Integrated diverter handle with independent temperature control	\$786	\$983	\$1140	\$1179
		VALVE REQUIRED, see page 338				

JACOBEBAN

			I	II	III	IV
3-2414TR		3/4" Thermostatic Trim Plate with Handle	\$831	\$1039	\$1205	\$1247
I-54O		VALVE REQUIRED 3/4" Thermostatic Rough-in Valve	\$1020	—	—	—
3-2404TR		3/4" Thermostatic Trim Plate with Handle	\$831	\$1039	\$1205	\$1247
I-54O		VALVE REQUIRED 3/4" Thermostatic Rough-in Valve	\$1020	—	—	—
3-373		Diverter/Flow Control Trim Use with stop or diverter valves, see page 347-348	\$286	\$357	\$415	\$429
3-374		Diverter/Flow Control Trim Use with stop or diverter valves, see page 347-348	\$286	\$357	\$415	\$429
2419		Bidet Set. Lever Handles 1/2" valves. Includes bottom spray with vacuum breaker, 4 hole mount bidet See page 330 for complete Bidet offering	\$1798	\$2247	\$2607	\$2697
34-09		Towel Ring	\$242	\$313	\$355	\$370
34-01		18" Towel Bar	\$363	—	\$527	\$545
34-02		24" Towel Bar	\$387	\$484	\$562	\$581

JACOBEBAN

			I	II	III	IV
34-12		Single Robe Hook	\$198	\$247	\$287	\$296
34-13		Double Robe Hook	\$234	\$292	\$339	\$350
34-27		Open Toilet Tissue Holder	\$238	\$298	\$345	\$357
34-28		Double Post Toilet Tissue Holder	\$342	\$427	\$495	\$512
2-645		Tank Lever for Jacobean Series	\$177	\$221	\$257	\$265
6-505		Tank Lever Mechanism	\$139	\$174	\$201	\$208







Coordinating Grab Bars starting on page 358



Jacobean Single Hole Lavatory Faucet in Oil Rubbed Bronze (10B) (see page 188)

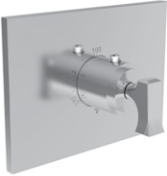

			I	II	III	IV
2570		Widespread Lavatory Faucet 1/2" valves. Spout reach 6.05" 8" centers	\$1500	\$1875	\$2175	\$2250
						
3-2576		Roman Tub Faucet Spout reach 9.29"	\$1836	\$2295	\$2663	\$2754
1-665		VALVE REQUIRED 3/4" valve for above Quick connect included	\$564	—	—	—
3-2577		Roman Tub Faucet with Hand Shower Spout reach 9.29"	\$2136	\$2692	\$3098	\$3204
1-666		VALVE REQUIRED 3/4" valve for above Includes hose & quick connect	\$1134	—	—	—
3-2575		Wall Mount Tub Faucet	\$1090	\$1363	\$1581	\$1635
1-500U		VALVE REQUIRED 2-valve rough with 1/2" NPT inlets & outlet	\$477	—	—	—
20-258		Tub Spout 3/4" NPT inlet fitting 7.35" spout length	\$381	\$488	\$581	\$581
4-2574 ^{BP}		Balanced Pressure Shower Trim Less showerhead, shower arm	\$780	\$986	\$1137	\$1171
1-684		VALVE REQUIRED Newport Brass Balanced Pressure Valve, 3 port with service stops, universal 1/2" NPT & direct sweat connections See Shower & Drain Sections to complete shower	\$365	—	—	—
5-2572 ^{BP}		Balanced Pressure Tub & Shower Trim Less tub spout, showerhead, shower arm	\$879	\$1113	\$1280	\$1319
1-685		VALVE REQUIRED Newport Brass Balanced Pressure Valve with diverter, 4 port with service stops, universal 1/2" NPT & direct sweat connections See Shower & Drain Sections to complete shower	\$503	—	—	—

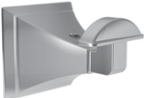
			I	II	III	IV
3-2574BP		Balanced Pressure Shower Set	\$1372	\$1802	\$2070	\$2175
1-684		VALVE REQUIRED Newport Brass Balanced Pressure Valve, 3 port with service stops, universal 1/2" NPT & direct sweat connections	\$365	—	—	—
3-2573TS		1/2" Thermostatic Trim Plate with Handles Integrated diverter handle with independent temperature control VALVE REQUIRED, see page 338	\$786	\$1023	\$1175	\$1200
3-2574TS		3/4" Thermostatic Trim Plate with Handle VALVE REQUIRED	\$831	\$1081	\$1242	\$1247
1-540		3/4" Thermostatic Rough-in Valve	\$1020	—	—	—
3-594		Diverter/Flow Control Trim Use with stop or diverter valves, see page 347-348	\$275	\$344	\$399	\$413
41-09		Towel Ring	\$295	\$368	\$428	\$442
41-02		24" Towel Bar	\$355	\$443	\$514	\$532
41-12		Single Robe Hook	\$165	\$207	\$240	\$248

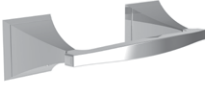
			I	II	III	IV
4I-27		Open Toilet Tissue Holder	\$276	\$345	\$400	\$414
4I-28		Double Post Toilet Tissue Holder	\$334	\$417	\$484	\$501

Coordinating Grab Bars starting on page 358















KIMBELL

		I	II	III	IV	
3420	  	Widespread Lavatory Faucet Lever Handles 1/2" valves. Spout reach 6.01" 8" centers	\$1850	\$2313	\$2683	\$2868
3420C	  	Widespread Lavatory Faucet Cross Handles 1/2" valves. Spout reach 6.00" 8" centers	\$1850	\$2313	\$2683	\$2868
3430	  	Widespread Lavatory Faucet Lever Handles 1/2" valves. Spout reach 6.01" 8" centers	\$1850	\$2313	\$2683	\$2868
3430C	  	Widespread Lavatory Faucet Cross Handles 1/2" valves. Spout reach 6.00" 8" centers	\$1850	\$2313	\$2683	\$2868
3423	  	Single Hole Lavatory Faucet 4.45" spout height at outlet 5.53" spout reach 9.67" overall height Includes pop-up assembly	\$1372	\$1715	\$1989	\$2058
101	 	Cover Plate 6" x 2-1/2"	\$120	\$157	\$174	\$180
3-3421	  	Wall Mount Lavatory Faucet Lever handles. Spout reach 8.25" 8" centers. Drain not included See Fittings #330, 3301, 3302, or 3303	\$1780	\$2225	\$2581	\$2759
I-532U		2-valve rough with 1/2" NPT inlets & outlet	\$477	—	—	—

KIMBELL

			I	II	III	IV
3-3431		Wall Mount Lavatory Faucet Cross handles. Spout reach 8.25" 8" centers. Drain not included. See Fittings #330, 3301, 3302, or 3303	\$1780	\$2225	\$2581	\$2759
		VALVE REQUIRED 				
I-532U		2-valve rough with 1/2" NPT inlets & outlet	\$477	—	—	—
3-3425		Wall Mount Tub Faucet with Lever Handles VALVE REQUIRED	\$1790	\$2238	\$2596	\$2775
						
I-500U		2-valve rough with 1/2" NPT inlets & outlet	\$477	—	—	—
3-3435		Wall Mount Tub Faucet with Cross Handles VALVE REQUIRED	\$1790	\$2238	\$2596	\$2775
						
I-500U		2-valve rough with 1/2" NPT inlets & outlet	\$477	—	—	—
3420-4273		Exposed Tub and Shower Set - Deck Mount Lever Handles Spout reach 9.20" 7.03" centers Includes: 283-101 handshower	\$3081	\$3851	\$4467	\$4776
						
3430-4272		Exposed Tub and Shower Set - Deck Mount Cross Handles Spout reach 9.20" 7.03" centers Includes: 283-101 handshower	\$3081	\$3851	\$4467	\$4776
						







KIMBELL

			I	II	III	IV
	3420-4283	 <p>Exposed Tub and Shower Set - Wall Mount Lever Handles Spout reach 9.20" 7.03" centers Includes: 283-101 handshower. No separate riser kit available</p> <p>VALVE REQUIRED</p>	\$2781	\$3476	\$4032	\$4311
	I-483	<p>Rough for Wall Mount Exposed Tub & Hand Shower Set 1/2" NPT eccentric nipple. Test caps included</p>	\$565	—	—	—
	3430-4282	 <p>Exposed Tub and Shower Set - Wall Mount Cross Handles Spout reach 9.20" 7.03" centers Includes: 283-101 handshower. No separate riser kit available</p> <p>VALVE REQUIRED</p>	\$2781	\$3476	\$4032	\$4311
	I-483	<p>Rough for Wall Mount Exposed Tub & Hand Shower Set 1/2" NPT eccentric nipple. Test caps included</p>	\$565	—	—	—
	3420-4263	 <p>Exposed Tub and Hand Shower Set with Risers Lever handles 35.24" (89.5 cm) spout height at outlet (from floor) 9.20" (23.4cm) spout reach 41.92" overall height 14 gallons (53 liters) per minute maximum flow rate (spout) 1.8 gallons (6.8 liters) per minute maximum flow rate (hand shower)</p> 	\$3881	\$4851	\$5627	\$6015
	I-469	<p>Required Rough for Exposed Tub Filler with Risers</p>	\$705	—	—	—
	3430-4262	 <p>Exposed Tub and Hand Shower Set with Risers Cross handles 35.24" (89.5 cm) spout height at outlet (from floor) 9.20" (23.4cm) spout reach 41.92" overall height 14 gallons (53 liters) per minute maximum flow rate (spout) 1.8 gallons (6.8 liters) per minute maximum flow rate (hand shower)</p> 	\$3881	\$4851	\$5627	\$6015
	I-469	<p>Required Rough for Exposed Tub Filler with Risers</p>	\$705	—	—	—
	3-677	 <p>Tub Spout 1/2" NPT inlet fitting 7.06" spout overall length</p>	\$484	\$605	\$702	\$751

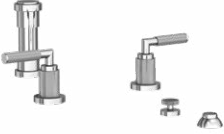
KIMBELL

		I	II	III	IV	
4-3424BP		Balanced Pressure Shower Trim with Lever Handle Less showerhead, shower arm	\$929	\$1161	\$1347	\$1440
NEW		VALVE REQUIRED				
I-684		Newport Brass Balanced Pressure Valve, 3 port with service stops, universal 1/2" NPT & direct sweat connections	\$365	—	—	—
		See Shower & Drain Sections to complete shower				
4-3434BP		Balanced Pressure Shower Trim with Cross Handle Less, showerhead, shower arm	\$929	\$1161	\$1347	\$1440
NEW		VALVE REQUIRED				
I-684		Newport Brass Balanced Pressure Valve, 3 port with service stops, universal 1/2" NPT & direct sweat connections	\$365	—	—	—
		See Shower & Drain Sections to complete shower				
5-3422BP		BP Shower Set. Lever Handle.	\$1029	\$1286	\$1492	\$1595
NEW		VALVE REQUIRED, see page 338				
5-3432BP		BP Shower Set. Cross Handle.	\$1029	\$1286	\$1492	\$1595
NEW		VALVE REQUIRED, see page 338				
3-3423TR		1/2" Thermostatic Trim Plate with Handles Integrated diverter handle with independent temperature control	\$1013	\$1266	\$1469	\$1570
NEW		VALVE REQUIRED, see page 338				
3-3433TR		1/2" Thermostatic Trim Plate with Handles Integrated diverter handle with independent temperature control	\$1013	\$1266	\$1469	\$1570
NEW		VALVE REQUIRED, see page 338				
3-3424TR		3/4" Thermostatic Trim Plate with Handle	\$1213	\$1516	\$1758	\$1880
NEW		VALVE REQUIRED				
I-540		3/4" Thermostatic Rough-in Valve	\$1020	—	—	—
3-3434TR		3/4" Thermostatic Trim Plate with Handle	\$1213	\$1516	\$1758	\$1880
NEW		VALVE REQUIRED				
I-540		3/4" Thermostatic Rough-in Valve	\$1020	—	—	—

KIMBELL

			I	II	III	IV
30-130		Diverter/Flow Control Trim Use with stop or diverter valves, see page 347-348	\$384	\$480	\$557	\$596
30-132		Diverter/Flow Control Trim Use with stop or diverter valves, see page 347-348	\$484	\$580	\$657	\$696
3429		Bidet Set Lever Handles. 1/2" valves Includes bottom spray with vacuum breaker, 4 hole mount bidet See page 330 for complete Bidet offering	\$2066	\$2583	\$2996	\$3202
3439		Bidet Set Lever Handles. 1/2" valves Includes bottom spray with vacuum breaker, 4 hole mount bidet See page 330 for complete Bidet offering	\$2066	\$2583	\$2996	\$3202
3290-1400		Towel Ring	\$409	\$511	\$593	\$614
3290-1230		18" Towel Bar	\$380	\$475	\$551	\$570
3290-1250		24" Towel Bar	\$421	\$526	\$611	\$632
3290-1650		Single Robe Hook	\$157	\$197	\$228	\$236
3290-1660		Double Robe Hook	\$208	\$259	\$301	\$311
3290-1570		Open Toilet Tissue Holder	\$283	\$353	\$410	\$424
3290-1500		Double Post Toilet Tissue Holder, Pivoting Arm	\$334	\$417	\$484	\$501

Coordinating Grab Bars starting on page 358

MALVINA

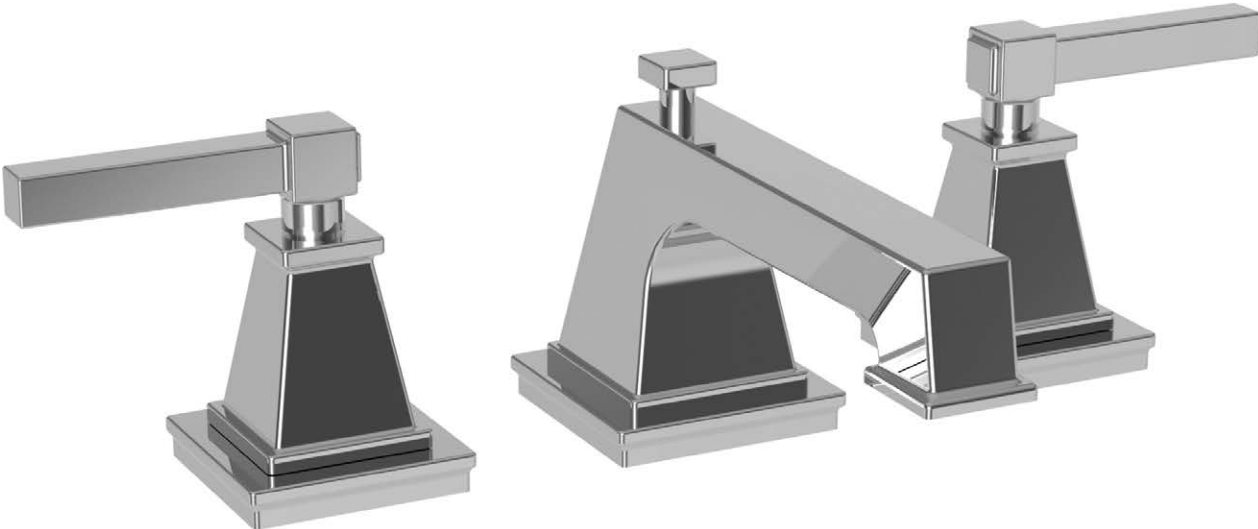

MALVINA

			I	II	III	IV
3140		Widespread Lavatory Faucet Lever Handles. 1/2" valves Spout reach 5.37". 8" centers	\$1357	\$1767	\$2060	\$2120
						
3150		Widespread Lavatory Faucet Cross Handles. 1/2" valves Spout reach 5.37". 8" centers	\$1357	\$1767	\$2060	\$2120
						
3-3146		Roman Tub Faucet Lever Handles. Spout reach 9.50"	\$1836	\$2295	\$2663	\$2754
I-665		VALVE REQUIRED 3/4" valve for above Quick connect included	\$564	—	—	—
3-3147		Roman Tub Faucet with Hand Shower Lever Handles. Spout reach 9.50"	\$2136	\$2670	\$3098	\$3204
		VALVE REQUIRED				
						
I-666		3/4" valve for above Includes hose & quick connect	\$1134	—	—	—
3-3145		Wall Mount Tub Faucet Lever Handles	\$1090	\$1363	\$1581	\$1635
		VALVE REQUIRED				
I-500U		2-valve rough with 1/2" NPT inlets & outlet	\$477	—	—	—
3-583		Tub Spout 1/2" NPT inlet fitting 7.92" spout length	\$411	\$514	\$596	\$617
4-3144BP		Balanced Pressure Shower Trim with Lever Handle Less tub spout, showerhead, shower arm	\$737	\$957	\$1105	\$1105
		VALVE REQUIRED				
I-684		Newport Brass Balanced Pressure Valve, 3 port with service stops, universal 1/2" NPT & direct sweat connections	\$365	—	—	—
		See Shower & Drain Sections to complete shower				

MALVINA

			I	II	III	IV
4-3154BP		Balanced Pressure Shower Trim with Cross Handle	\$737	\$957	\$1105	\$1105
I-684		VALVE REQUIRED Newport Brass Balanced Pressure Valve, 3 port with service stops, universal 1/2" NPT & direct sweat connections See Shower & Drain Sections to complete shower.	\$365	—	—	—
5-3142BP		Balanced Pressure Tub & Shower Trim with Lever Handle Less tub spout, showerhead, shower arm	\$829	\$1080	\$1245	\$1245
I-685		VALVE REQUIRED Newport Brass Balanced Pressure Valve with diverter, 4 port with service stops, universal 1/2" NPT & direct sweat connections See Shower & Drain Sections to complete shower	\$503	—	—	—
5-3152BP		Balanced Pressure Tub & Shower Trim with Cross Handle Less tub spout, showerhead, shower arm	\$829	\$1080	\$1245	\$1245
I-685		VALVE REQUIRED Newport Brass Balanced Pressure Valve with diverter, 4 port with service stops, universal 1/2" NPT & direct sweat connections See Shower & Drain Sections to complete shower	\$503	—	—	—
3-3144BP		Balanced Pressure Shower Set. Lever Handle	\$1279	\$1721	\$1988	\$2050
I-684		VALVE REQUIRED Newport Brass Balanced Pressure Valve, 3 port with service stops, universal 1/2" NPT & direct sweat connections	\$365	—	—	—
3-3143TS		1/2" Thermostatic Trim Plate with Handles Integrated diverter handle with independent temperature control	\$913	\$1206	\$1386	\$1386
		VALVE REQUIRED, see page 338				
3-3153TS		1/2" Thermostatic Trim Plate with Handles Integrated diverter handle with independent temperature control	\$913	\$1206	\$1386	\$1386
		VALVE REQUIRED, see page 338				
3-3144TS		3/4" Thermostatic Trim Plate with Handle	\$979	\$1273	\$1440	\$1469
I-540		VALVE REQUIRED 3/4" Thermostatic Rough-in Valve	\$1020	—	—	—

MALVINA

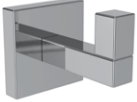
			I	II	III	IV
3-3154TS		3/4" Thermostatic Trim Plate with Handle	\$979	\$1273	\$1440	\$1469
1-540		VALVE REQUIRED 3/4" Thermostatic Rough-in Valve	\$1020	—	—	—
3-580		Diverter/Flow Control Trim Use with stop or diverter valves, see page 347-348	\$329	\$411	\$476	\$493
3-581		Diverter/Flow Control Trim Use with stop or diverter valves, see page 347-348	\$329	\$411	\$476	\$493
2020-1200		8" Towel Bar	\$235	\$294	\$341	\$353
2020-1230		18" Towel Bar	\$276	\$345	\$400	\$414
2020-1250		24" Towel Bar	\$324	\$405	\$470	\$486
2020-1650		Single Robe Hook	\$120	\$150	\$174	\$180
2020-1570		Open Toilet Tissue Holder	\$263	\$329	\$381	\$395
2020-1500		Double Post Toilet Tissue Holder	\$308	\$385	\$446	\$462

Coordinating Grab Bars starting on page 358





METROPOLE







METROPOLE

		I	II	III	IV
1200	 <p>Widespread Lavatory Faucet Lever handles 1/2" valves. Spout reach 5.62" 8" centers</p> 	\$1214	\$1518	\$1761	\$1821
1220	 <p>Widespread Lavatory Faucet Cross handles 1/2" valves. Spout reach 5.62" 8" centers</p> 	\$1214	\$1518	\$1761	\$1821
1230	 <p>Widespread Lavatory Faucet Crystal Handles 1/2" valves. Spout reach 5.62" 8" centers</p> 	\$1257	\$1680	\$1849	\$1905
1200C	 <p>Widespread Lavatory Faucet Lever handles 1/2" valves. Spout reach 5.79" 8" centers</p> 	\$1357	\$1697	\$1968	\$2036
1230C	 <p>Widespread Lavatory Faucet Crystal Handles 1/2" valves. Spout reach 5.79" 8" centers</p> 	\$1381	\$1752	\$1968	\$2036
1220C	 <p>Widespread Lavatory Faucet Cross handles 1/2" valves. Spout reach 5.79" 8" centers</p> 	\$1357	\$1697	\$1968	\$2036
1203	 <p>Single Hole Lavatory Faucet 4.32" spout height at outlet 5.59" spout reach 8.02" overall height Includes pop-up assembly</p> 	\$1168	\$1460	\$1745	\$1752
101	 <p>Cover Plate 6" x 2-1/2"</p>	\$120	\$157	\$174	\$180

METROPOLE

		I	II	III	IV
1233	 <p>Single Hole Lavatory Faucet with Crystal Handle 4.32" spout height at outlet 5.59" spout reach 8.02" overall height Includes pop-up assembly</p> 	\$1268	\$1624	\$1863	\$1902
101	 <p>Cover Plate 6" x 2-1/2"</p>	\$120	\$157	\$174	\$180
1203-1	 <p>Single Hole Vessel Faucet 7.51" spout height at outlet 5.59" spout reach 10.91" overall height Drain not included. For Lavatory sink drains, see Fittings # 330, 3301, 3302 or 3303</p> 	\$1268	\$1585	\$1839	\$1902
101	 <p>Cover Plate 6" x 2-1/2"</p>	\$120	\$157	\$174	\$180
1233-1	 <p>Single Hole Vessel Faucet with Crystal Handle 7.51" spout height at outlet 5.59" spout reach 10.91" overall height Drain not included. For lavatory sink drains, see Fittings # 330, 3301, 3302 or 3303</p> 	\$1372	\$1781	\$2048	\$2058
101	 <p>Cover Plate 6" x 2-1/2"</p>	\$120	\$157	\$174	\$180
3-1201	 <p>Wall Mount Lavatory Faucet Lever Handles. Spout reach 7.50" 8" centers. Drain not included See Fittings #330, 3301, 3302, or 3303</p> <p>VALVE REQUIRED</p> 	\$944	\$1180	\$1369	\$1416
1-532U	<p>2-valve rough with 1/2" NPT inlets & outlet</p>	\$477	—	—	—



METROPOLE

			I	II	III	IV
3-1231		Wall Mount Lavatory Faucet Crystal Handle Spout reach 7.50". 8" centers. Drain not included See Fittings #330, 3301, 3302, or 3303	\$1011	\$1417	\$1698	\$1698
I-532U		VALVE REQUIRED 2-valve rough with 1/2" NPT inlets & outlet	\$477	—	—	—
						
3-1221		Wall Mount Lavatory Faucet Cross Handles. Spout reach 7.50" 8" centers. Drain not included See Fittings #330, 3301, 3302, or 3303	\$944	\$1180	\$1369	\$1416
I-532U		VALVE REQUIRED 2-valve rough with 1/2" NPT inlets & outlet	\$477	—	—	—
						
3-1206		Roman Tub Faucet with Lever Handles Spout reach 9.27"	\$1520	\$1900	\$2204	\$2280
I-502		VALVE REQUIRED 3/4" valve for above, quick connect included	\$564	—	—	—
3-1236		Roman Tub Faucet with Crystal Handles Spout reach 9.27"	\$1520	\$1917	\$2213	\$2280
I-502		VALVE REQUIRED 3/4" valve for above, quick connect included	\$564	—	—	—
3-1207		Roman Tub Faucet with Hand Shower Lever Handles. Spout reach 9.27"	\$1820	\$2275	\$2639	\$2730
I-503		VALVE REQUIRED 3/4" valve for above. Includes Nos. 289 and 290 roughs and quick connect	\$1134	—	—	—
						
3-1237		Roman Tub Faucet with Hand Shower Crystal Handles Spout reach 9.27". Set includes: 1 each No. 280 Hand Shower, No. 284 59" Hose, No.289 Deck Flange Kit	\$1920	\$2418	\$2792	\$2880
I-503		VALVE REQUIRED 3/4" valve for above. Includes Nos. 289 and 290 roughs and quick connect	\$1134	—	—	—
						

METROPOLE

			I	II	III	IV
3-1205		Wall Mount Tub Faucet with Lever Handles	\$1090	\$1363	\$1581	\$1635
1-500U		VALVE REQUIRED 2-valve rough with 1/2" NPT inlets & outlet	\$477	—	—	—
2-144		Tub Spout 1/2" NPT inlet fitting 7.56" spout length	\$277	\$347	\$402	\$416
1200-4273		Exposed Tub and Hand Shower Set Deck Mount 7.25" centers. Spout reach 9.11" Includes: 281 Hand Shower	\$2171	\$2713	\$3147	\$3256
						
1200-4283		Exposed Tub and Hand Shower Set - Wall Mount 6" centers. Spout reach 7" Includes: 281 Hand Shower Floor-mount kit item 3-196 or 3-226 sold separately	\$2071	\$2589	\$3003	\$3107
1-378		Required Rough for Exposed Tub Filler For use with 3-196 or 3-226 tub risers	\$549	—	—	—
3-196		Floor Mount Kit for Exposed Tub Sets Set includes: 2 each Floor Flanges 2 each 3/4" Risers - 31" high Decorative Stabilizer Kit sold separately	\$767	\$980	\$1175	\$1175
3-226		Same as above only 24" high	\$736	\$944	\$1135	\$1135
3-192		3/4" Shut-off Valves for above (1 pair hot & cold)	\$1077	\$1347	\$1562	\$1616
2-734		Decorative Stabilizer Kit for Exposed Tub Floor Riser Kits Adjustable for risers that are 6" to 9" apart. Includes 1-1/2" finished ring for connecting kit to tub overflow pipe. Finished plate for wall mounting up to 10" center of riser pipes.	\$378	\$472	\$547	\$566
		Wall Mount Plate				

METROPOLE

			I	II	III	IV
4-1204BP		Balanced Pressure Shower Trim with Lever Handle Less showerhead, shower arm	\$704	\$880	\$1021	\$1056
1-684		VALVE REQUIRED Newport Brass Balanced Pressure Valve, 3 port with service stops, universal 1/2" NPT & direct sweat connections See Shower & Drain Sections to complete shower	\$365	—	—	—
4-1234BP		Balanced Pressure Shower Trim with Crystal Handle Less showerhead, shower arm	\$748	\$973	\$1125	\$1125
1-684		VALVE REQUIRED Newport Brass Balanced Pressure Valve, 3 port with service stops, universal 1/2" NPT & direct sweat connections See Shower & Drain Sections to complete shower	\$365	—	—	—
4-1224BP		Balanced Pressure Shower Trim with Cross Handle Less showerhead, shower arm	\$704	\$880	\$1021	\$1056
1-684		VALVE REQUIRED Newport Brass Balanced Pressure Valve, 3 port with service stops, universal 1/2" NPT & direct sweat connections See Shower & Drain Sections to complete shower	\$365	—	—	—
5-1202BP		Balanced Pressure Tub & Shower Trim with Lever Handle Less tub spout, showerhead, shower arm	\$794	\$993	\$1152	\$1191
1-685		VALVE REQUIRED Newport Brass Balanced Pressure Valve with diverter, 4 port with service stops, universal 1/2" NPT & direct sweat connections See Shower & Drain Sections to complete shower	\$503	—	—	—
5-1232BP		Balanced Pressure Tub & Shower Trim with Crystal Handle Less tub spout, showerhead, shower arm and flange	\$894	\$1118	\$1297	\$1341
1-685		VALVE REQUIRED Newport Brass Balanced Pressure Valve with diverter, 4 port with service stops, universal 1/2" NPT & direct sweat connections See Shower & Drain Sections to complete shower	\$503	—	—	—



METROPOLE

			I	II	III	IV
5-1222BP		Balanced Pressure Tub & Shower Trim with Cross Handle Less tub spout, showerhead, shower arm	\$794	\$993	\$1152	\$1191
1-685		VALVE REQUIRED Newport Brass Balanced Pressure Valve with diverter, 4 port with service stops, universal 1/2" NPT & direct sweat connections See Shower & Drain Sections to complete shower	\$503	—	—	—
3-1204BP		Balanced Pressure Shower Set. Lever Handle	\$863	\$1079	\$1252	\$1295
1-684		VALVE REQUIRED Newport Brass Balanced Pressure Valve, 3 port with service stops, universal 1/2" NPT & direct sweat connections See Shower & Drain Sections to complete shower	\$365	—	—	—
3-1203TR		1/2" Thermostatic Trim Plate with Handles Integrated diverter handle with independent temperature control	\$786	\$983	\$1140	\$1179
		VALVE REQUIRED, see page 338				
3-923TR		1/2" Thermostatic Trim Plate with Handles Integrated diverter handle with independent temperature control	\$786	\$983	\$1140	\$1179
		VALVE REQUIRED, see page 338				
3-1203TS		1/2" Thermostatic Trim Plate with Handles Integrated diverter handle with independent temperature control	\$786	\$983	\$1140	\$1179
		VALVE REQUIRED, see page 338				
3-923TS		1/2" Thermostatic Trim Plate with Handles Integrated diverter handle with independent temperature control	\$786	\$983	\$1140	\$1179
		VALVE REQUIRED, see page 338				
3-1204TR		3/4" Thermostatic Trim Plate with Handle	\$639	\$799	\$927	\$959
1-540		VALVE REQUIRED 3/4" Thermostatic Rough-in Valve	\$1020	—	—	—

METROPOLE

			I	II	III	IV
3-924TR		3/4" Thermostatic Trim Plate with Handle	\$639	\$799	\$927	\$959
I-540		VALVE REQUIRED 3/4" Thermostatic Rough-in Valve	\$1020	—	—	—
3-245		Diverter/Flow Control Trim Use with stop or diverter valves, see page 347-348	\$253	\$324	\$390	\$390
3-447		Diverter/Flow Control Handle Crystal Handle Use with stop or diverter valves, see page 347-348	\$464	\$580	\$672	\$695
3-595		Diverter/Flow Control Trim with Arrow Insert Use with stop or diverter valves, see page 347-348	\$253	\$324	\$390	\$390
1200-1400		Towel Ring - Open	\$235	\$293	\$340	\$352
1200-1230		18" Towel Bar	\$272	\$340	\$394	\$408
1200-1250		24" Towel Bar	\$323	\$404	\$469	\$485
1200-1660		Double Robe Hook	\$160	\$199	\$231	\$239

METROPOLE

			I	II	III	IV
1200-1510		Hanging Toilet Tissue Holder	\$251	\$314	\$364	\$377
1200-1500		Double Post Toilet Tissue Holder	\$352	\$440	\$511	\$528
2-279		Tank Lever for Metropole series	\$204	\$255	\$296	\$306
6-505		Tank Lever Mechanism	\$139	\$174	\$201	\$208

Coordinating Grab Bars starting on page 358



NEW Kimbell Widespread Lavatory Faucet in Aged Brass (034) (see page 200)







MIRO

			I	II	III	IV
1620		Widespread Lavatory Faucet Lever Handles 1/2" valves. Spout reach 5.55" 8" centers.	\$1214	\$1566	\$1779	\$1821
						
1600		Widespread Lavatory Faucet Cross Handles 1/2" valves. Spout reach 5.55" 8" centers.	\$1214	\$1566	\$1779	\$1821
						
1623-1		Single Hole Lavatory Faucet 4.29" spout height at outlet 6.19" spout reach 9.21" overall height Includes pop-up assembly	\$1168	\$1489	\$1745	\$1752
101		Cover Plate 6" x 2-1/2".	\$120	\$157	\$174	\$180
						
3-1626		Roman Tub Faucet Lever Handles. Spout reach 9.06"	\$1520	\$1900	\$2204	\$2280
		VALVE REQUIRED				
1-506		3/4" valves for above. Quick connect included	\$564	—	—	—
3-1627		Roman Tub Faucet with Hand Shower Lever Handles. Spout reach 9.06"	\$1820	\$2275	\$2639	\$2730
		VALVE REQUIRED				
1-503		3/4" valve for above. Includes hose and quick connect	\$1134	—	—	—
						
3-1625		Wall Mount Tub Faucet Lever Handles	\$1090	\$1363	\$1581	\$1635
		VALVE REQUIRED				
1-500U		2-valve rough with 1/2" NPT inlets & outlet	\$477	—	—	—
1620-4273		Exposed Tub and Hand Shower Set Deck Mount Lever Handles 7.25" centers Spout reach 9.11" Includes: 281 Hand Shower	\$2081	\$2602	\$3082	\$3122
						

MIRO

			I	II	III	IV
1600-4272		Exposed Tub and Hand Shower Set Deck Mount Cross Handles 7.25" centers. Spout reach 9.11" Includes: 281 Hand Shower	\$2081	\$2602	\$3082	\$3122
						
1620-4283		Exposed Tub and Hand Shower Set Wall Mount Lever Handles 6" centers. Spout reach 7" Includes: 281 Hand Shower Floor-mount kit item 3-196 or 3-226 sold separately	\$2071	\$2589	\$3003	\$3107
						
1-378		Required Rough for Exposed Tub Filler For use with 3-196 or 3-226 tub risers	\$549	—	—	—
1600-4282		Exposed Tub and Hand Shower Set Wall Mount Cross Handles 6" centers. Spout reach 7" Includes: 281 Hand Shower Floor-mount kit item 3-196 or 3-226 sold separately	\$2081	\$2602	\$3018	\$3122
						
1-378		Required Rough for Exposed Tub Filler For use with 3-196 or 3-226 tub risers	\$549	—	—	—
3-196		Floor Mount Kit for Exposed Tub Sets Set includes: 2 each Floor Flanges 2 each 3/4" Risers - 31" high Decorative Stabilizer Kit sold separately	\$767	\$980	\$1175	\$1175
3-226		Same as above only 24" high	\$736	\$944	\$1135	\$1135
3-192		3/4" Shut-off Valves for above (1 pair hot & cold)	\$1077	\$1347	\$1562	\$1616
2-734		Decorative Stabilizer Kit for Exposed Tub Floor Riser Kits Adjustable for risers that are 6" to 9" apart Includes 1-1/2" finished ring for connecting kit to tub overflow pipe. Finished plate for wall mounting up to 10" center of riser pipes	\$378	\$472	\$547	\$566
		Wall Mount Plate				
2-564		Tub Spout with Stream Straightener 3/4" NPT inlet (1/2" bushing included) 7.43" spout length	\$312	\$390	\$453	\$468

MIRO

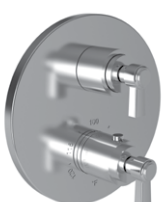
			I	II	III	IV
4-1624BP		Balanced Pressure Shower Trim with Lever Handle Less showerhead, shower arm	\$704	\$880	\$1021	\$1056
1-684		VALVE REQUIRED Newport Brass Balanced Pressure Valve, 3 port with service stops, universal 1/2" NPT & direct sweat connections See Shower & Drain Sections to complete shower.	\$365	—	—	—
4-1604BP		Balanced Pressure Tub & Shower Trim with Cross Handle Less showerhead, shower arm	\$704	\$880	\$1021	\$1056
1-684		VALVE REQUIRED Newport Brass Balanced Pressure Valve, 3 port with service stops, universal 1/2" NPT & direct sweat connections See Shower & Drain Sections to complete shower	\$365	—	—	—
5-1622BP		Balanced Pressure Tub & Shower Trim with Lever Handle Less tub spout, showerhead, shower arm	\$794	\$993	\$1152	\$1191
1-685		VALVE REQUIRED Newport Brass Balanced Pressure Valve with diverter, 4 port with service stops, universal 1/2" NPT & direct sweat connections See Shower & Drain Sections to complete shower	\$503	—	—	—
5-1602BP		Balanced Pressure Tub & Shower Trim with Cross Handle Less tub spout, showerhead, shower arm	\$794	\$993	\$1152	\$1191
1-685		VALVE REQUIRED Newport Brass Balanced Pressure Valve with diverter, 4 port with service stops, universal 1/2" NPT & direct sweat connections See Shower & Drain Sections to complete shower	\$503	—	—	—
3-1624BP		Balanced Pressure Shower Set. Lever Handle	\$863	\$1121	\$1295	\$1295
1-684		VALVE REQUIRED Newport Brass Balanced Pressure Valve, 3 port with service stops, universal 1/2" NPT & direct sweat connections	\$365	—	—	—
3-1623TR		1/2" Thermostatic Trim Plate with Handles Integrated diverter handle with independent temperature control VALVE REQUIRED, see page 338	\$786	\$983	\$1140	\$1179

MIRO

			I	II	III	IV
3-1603TR		1/2" Thermostatic Trim Plate with Handles Integrated diverter handle with independent temperature control VALVE REQUIRED, see page 338	\$786	\$983	\$1140	\$1179
3-1624TR		3/4" Thermostatic Trim Plate with Handle VALVE REQUIRED	\$639	\$802	\$927	\$959
I-540		3/4" Thermostatic Rough-in Valve	\$1020	—	—	—
3-1604TR		3/4" Thermostatic Trim Plate with Handle VALVE REQUIRED	\$639	\$802	\$927	\$959
I-540		3/4" Thermostatic Rough-in Valve	\$1020	—	—	—
3-279L		Diverter/Flow Control Trim Use with stop or diverter valves, see page 347-348	\$309	\$394	\$473	\$473
3-279		Diverter/Flow Control Trim Use with stop or diverter valves, see page 347-348	\$309	\$394	\$473	\$473
2-436		Tank Lever for Miro Series	\$161	\$201	\$233	\$241
6-505		Tank Lever Mechanism	\$139	\$174	\$201	\$208
1600-1200		8" Towel Bar	\$230	\$288	\$334	\$345
1600-1230		18" Towel Bar	\$260	\$325	\$377	\$390
1600-1250		24" Towel Bar	\$300	\$375	\$435	\$450

MIRO

			I	II	III	IV
1600-1660		Double Robe Hook	\$150	\$188	\$218	\$225

1600-1500		Double Post Toilet Tissue Holder	\$300	\$375	\$435	\$450
-----------	---	----------------------------------	-------	-------	-------	-------

Coordinating Grab Bars starting on page 358



MUNCY

			I	II	III	IV
3290		Widespread Lavatory Faucet Lever Handles 1/2" valves. Spout reach 7.13" 8" centers	\$1500	\$1875	\$2175	\$2250
						
3300		Widespread Lavatory Faucet Cross Handles 1/2" valves. Spout reach 7.13" 8" centers	\$1500	\$1875	\$2175	\$2250
						
3360		Widespread Lavatory Faucet Lever Handles 1/2" valves. Spout reach 6.13" 8" centers	\$1500	\$1875	\$2175	\$2250
						
3370		Widespread Lavatory Faucet Cross Handles 1/2" valves. Spout reach 6.13" 8" centers	\$1500	\$1875	\$2175	\$2250
						
3293		Single Hole Lavatory Faucet 2.97" spout height at outlet 5.62" spout reach 9.16" overall height Includes pop-up assembly	\$1168	\$1489	\$1745	\$1752
101		Cover Plate 6" x 2.5"	\$120	\$157	\$174	\$180
						
3-329I		Wall Mount Lavatory Faucet Lever handles. Spout reach 9.50" 8" centers. Drain not included See Fittings #330, 3301, 3302, or 3303	\$1163	\$1454	\$1687	\$1730
1-532U		VALVE REQUIRED 2-valve rough with 1/2" NPT inlets & outlet	\$477	—	—	—
						









MUNCY

		I	II	III	IV
3-3301	 <p>Wall Mount Lavatory Faucet Cross handles. Spout reach 9.50" 8" centers. Drain not included. See Fittings #330, 3301, 3302, or 3303</p> <p>VALVE REQUIRED</p> 	\$1163	\$1454	\$1687	\$1730
1-532U	2-valve rough with 1/2" NPT inlets & outlet	\$477	—	—	—
3-3296	 <p>Roman Tub Faucet Lever Handles. Spout reach 7.88"</p> <p>VALVE REQUIRED</p>	\$1836	\$2295	\$2663	\$2754
1-665	3/4" valve for above Quick connect included	\$564	—	—	—
3-3297	 <p>Roman Tub Faucet with Hand Shower Lever Handles. Spout reach 7.88"</p> <p>VALVE REQUIRED</p> 	\$2136	\$2670	\$3098	\$3204
1-666	3/4" valve for above Includes hose & quick connect	\$1134	—	—	—
3-3295	 <p>Wall Mount Tub Faucet with Lever Handles</p> <p>VALVE REQUIRED</p>	\$1090	\$1386	\$1607	\$1635
1-500U	2-valve rough with 1/2" NPT inlets & outlet	\$477	—	—	—
3290-4261	 <p>Free Standing Tub Filler 37.26" (94.7cm) spout height at outlet (from floor) 8.73" (22.2cm) spout reach 43" overall height 9.25 gallons (35 liters) per minute maximum flow rate (spout)</p> 	\$2862	\$3578	\$4150	\$4293
1-339	<p>Rough for Freestanding Tub Filler For subfloor and concrete floor installations 4.53" overall height 7.20" overall base diameter Universal 3/4" NPT and 1/2" direct sweat connections Test caps included</p> <p>SEE PAGE 307</p>	\$434	—	—	—
3-695	 <p>Tub Spout with Stream Straightener 3/4" NPT inlet (1/2" bushing included) 9.94" spout length</p>	\$351	\$439	\$509	\$527

MUNCY

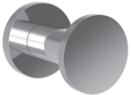
			I	II	III	IV
4-3304BP		Balanced Pressure Shower Trim with Cross Handle Less showerhead, shower arm	\$744	\$1039	\$1187	\$1247
I-684		VALVE REQUIRED Newport Brass Balanced Pressure Valve, 3 port with service stops, universal 1/2" NPT & direct sweat connections See Shower & Drain Sections to complete shower.	\$365	—	—	—
4-3294BP		Balanced Pressure Tub & Shower Trim with Lever Handle Less tub spout, showerhead, shower arm	\$744	\$1039	\$1187	\$1187
I-684		VALVE REQUIRED Newport Brass Balanced Pressure Valve, 3 port with service stops, universal 1/2" NPT & direct sweat connections See Shower & Drain Sections to complete shower.	\$365	—	—	—
5-3292BP		Balanced Pressure Tub & Shower Trim with Lever Handle Less tub spout, showerhead, shower arm	\$894	\$1171	\$1314	\$1341
I-685		VALVE REQUIRED Newport Brass Balanced Pressure Valve with diverter, 4 port with service stops, universal 1/2" NPT & direct sweat connections See Shower & Drain Sections to complete shower	\$503	—	—	—
5-3302BP		Balanced Pressure Tub & Shower Trim with Cross Handle Less tub spout, showerhead, shower arm	\$894	\$1171	\$1314	\$1341
I-685		VALVE REQUIRED Newport Brass Balanced Pressure Valve with diverter, 4 port with service stops, universal 1/2" NPT & direct sweat connections See Shower & Drain Sections to complete shower	\$503	—	—	—
3-3293TR		1/2" Thermostatic Trim Plate with Handles Integrated diverter handle with independent temperature control	\$913	\$1278	\$1473	\$1473
		VALVE REQUIRED, see page 338				
3-3303TR		1/2" Thermostatic Trim Plate with Handles Integrated diverter handle with independent temperature control	\$913	\$1278	\$1473	\$1473
		VALVE REQUIRED, see page 338				
3-3294TR		3/4" Thermostatic Trim Plate with Handle	\$979	\$1224	\$1432	\$1469
I-540		VALVE REQUIRED 3/4" Thermostatic Rough-in Valve	\$1020	—	—	—

MUNCY

			I	II	III	IV
3-3304TR		3/4" Thermostatic Trim Plate with Handle VALVE REQUIRED	\$979	\$1224	\$1432	\$1469
I-540		3/4" Thermostatic Rough-in Valve	\$1020	—	—	—
3-692		Diverter/Flow Control Trim Use with stop or diverter valves, see page 347-348	\$290	\$373	\$465	\$465
3-693		Diverter/Flow Control Trim Use with stop or diverter valves, see page 347-348	\$290	\$373	\$465	\$465
3290-1400		Towel Ring	\$409	\$511	\$593	\$614
3290-1230		18" Towel Bar	\$380	\$475	\$551	\$570
3290-1250		24" Towel Bar	\$421	\$526	\$611	\$632
3290-1650		Single Robe Hook	\$157	\$197	\$228	\$236
3290-1660		Double Robe Hook	\$208	\$259	\$301	\$311
3290-1570		Open Toilet Tissue Holder	\$283	\$353	\$410	\$424
3290-1500		Double Post Toilet Tissue Holder, Pivoting Arm	\$334	\$417	\$484	\$501

Coordinating Grab Bars starting on page 358



Pardees Widespread Lavatory Faucet in Polished Chrome (26) (see page 234)

PARDEES



PARDEES

			I	II	III	IV
3230C		Widespread Lavatory Faucet Lever Handles 1/2" valves. Spout reach to 5.63" 8" centers	\$1500	\$1875	\$2175	\$2250
						
3230		Widespread Lavatory Faucet Lever Handles 1/2" valves. Spout reach 6.13" 8" centers	\$1500	\$1875	\$2175	\$2250
						
3240C		Widespread Lavatory Faucet Cross Handles 1/2" valves. Spout reach to 5.63" 8" centers	\$1500	\$1875	\$2175	\$2250
						
3240		Widespread Lavatory Faucet Cross Handles 1/2" valves. Spout reach 6.13" 8" centers	\$1500	\$1875	\$2175	\$2250
						
3233		Single Hole Lavatory Faucet 4.31" spout height at outlet 6.19" spout reach 9.05" overall height Includes pop-up assembly	\$1168	\$1489	\$1745	\$1752
						
101		Cover Plate 6" x 2.5"	\$120	\$157	\$174	\$180
3-3231		Wall Mount Lavatory Faucet Lever handles. Spout reach 8.25" 8" centers. Drain not included See Fittings #330, 3301, 3302, or 3303	\$1163	\$1454	\$1687	\$1730
		VALVE REQUIRED				
I-532U		2-valve rough with 1/2" NPT inlets & outlet	\$477	—	—	—







PARDEES

		I	II	III	IV
3-3241	 <p>Wall Mount Lavatory Faucet Cross handles. Spout reach 8.25" 8" centers. Drain not included See Fittings #330, 3301, 3302, or 3303</p> <p>VALVE REQUIRED</p> 	\$1163	\$1454	\$1687	\$1730
1-532U	<p>2-valve rough with 1/2" NPT inlets & outlet</p>	\$477	—	—	—
3-3236	 <p>Roman Tub Faucet Lever Handles. Spout reach 8.25"</p> <p>VALVE REQUIRED</p>	\$1610	\$2067	\$2375	\$2415
1-697	 <p>3/4" Valve for above. Quick connect included</p>	\$564	—	—	—
3-3237	 <p>Roman Tub Faucet with Hand Shower Lever Handles. Spout reach 8.25"</p> <p>VALVE REQUIRED</p> 	\$2136	\$2670	\$3098	\$3204
1-698	<p>3/4" valve for above. Includes hose and quick connect</p>	\$1134			
3-3235	 <p>Wall Mount Tub Faucet with Lever Handles</p> <p>VALVE REQUIRED</p>	\$1090	\$1386	\$1607	\$1635
1-500U	 <p>2-valve rough with 1/2" NPT inlets & outlet</p>	\$477	—	—	—
3-3245	 <p>Wall Mount Tub Faucet with Cross Handles</p> <p>VALVE REQUIRED</p>	\$1090	\$1386	\$1607	\$1635
1-500U	 <p>2-valve rough with 1/2" NPT inlets & outlet</p>	\$477	—	—	—
3-641	 <p>Tub Spout with Stream Straightener 1/2" NPT inleft fitting. 8.75" spout length</p>	\$436	\$545	\$633	\$654

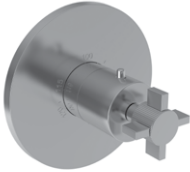
PARDEES

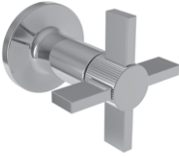
			I	II	III	IV
4-3234BP		Balanced Pressure Tub & Shower Trim with Lever Handle Less showerhead, shower arm	\$744	\$1039	\$1187	\$1187
		VALVE REQUIRED				
I-684		Newport Brass Balanced Pressure Valve, 3 port with service stops, universal 1/2" NPT & direct sweat connections	\$365	—	—	—
		See Shower & Drain Sections to complete shower.				
4-3244BP		Balanced Pressure Tub & Shower Trim with Cross Handle Less showerhead, shower arm	\$744	\$1039	\$1187	\$1187
		VALVE REQUIRED				
I-684		Newport Brass Balanced Pressure Valve, 3 port with service stops, universal 1/2" NPT & direct sweat connections	\$365	—	—	—
		See Shower & Drain Sections to complete shower.				
5-3232BP		Balanced Pressure Tub & Shower Trim with Lever Handle Less tub spout, showerhead, shower arm	\$894	\$1171	\$1314	\$1341
		VALVE REQUIRED				
I-685		Newport Brass Balanced Pressure Valve with diverter, 4 port with service stops, universal 1/2" NPT & direct sweat connections	\$503	—	—	—
		See Shower & Drain Sections to complete shower				
5-3242BP		Balanced Pressure Tub & Shower Trim with Cross Handle Less tub spout, showerhead, shower arm	\$894	\$1171	\$1314	\$1341
		VALVE REQUIRED				
I-685		Newport Brass Balanced Pressure Valve with diverter, 4 port with service stops, universal 1/2" NPT & direct sweat connections	\$503	—	—	—
		See Shower & Drain Sections to complete shower				
3-3233TR		1/2" Thermostatic Trim Plate with Handles Integrated diverter handle with independent temperature control	\$913	\$1278	\$1473	\$1473
		VALVE REQUIRED, see page 338				
3-3243TR		1/2" Thermostatic Trim Plate with Handles Integrated diverter handle with independent temperature control	\$913	\$1278	\$1473	\$1473
		VALVE REQUIRED, see page 338				
3-3234TR		3/4" Thermostatic Trim Plate with Handle	\$979	\$1224	\$1432	\$1469
		VALVE REQUIRED				
I-540		3/4" Thermostatic Rough-in Valve	\$1020	—	—	—

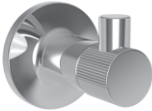
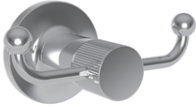
PARDEES

			I	II	III	IV
3-3244TR		3/4" Thermostatic Trim Plate with Handle	\$979	\$1224	\$1432	\$1469
I-540		VALVE REQUIRED 3/4" Thermostatic Rough-in Valve	\$1020	—	—	—
3-644		Diverter/Flow Control Trim Use with stop or diverter valves, see page 347-348	\$302	\$378	\$465	\$465
3-645		Diverter/Flow Control Trim Use with stop or diverter valves, see page 347-348	\$329	\$411	\$476	\$493
3230-1410		Towel Ring	\$289	\$362	\$419	\$434
3230-1230		18" Towel Bar	\$379	\$473	\$549	\$568
3230-1250		24" Towel Bar	\$421	\$526	\$611	\$632
3230-1650		Single Robe Hook	\$236	\$295	\$365	\$365
3230-1660		Double Robe Hook	\$268	\$334	\$393	\$401
3230-1510		Hanging Toilet Tissue Holder	\$286	\$357	\$415	\$429

PARDEES

		I	II	III	IV
3230-1530	Double Post Toilet Tissue Holder	\$393	\$491	\$569	\$589



Coordinating Grab Bars starting on page 358



PAVANI

		I	II	III	IV
3110	 	\$1286	\$1608	\$1865	\$1929
	<p>Widespread Lavatory Faucet 1/2" valves. 8" centers Spout reach 5.74"</p>				
3100	 	\$1286	\$1608	\$1865	\$1929
	<p>Widespread Lavatory Faucet 1/2" valves. 8" centers Spout reach 5.54"</p>				
2480	 	\$1286	\$1608	\$1865	\$1929
	<p>Widespread Lavatory Faucet 1/2" valves. 8" centers Spout reach 5.54"</p>				
3130	 	\$1286	\$1608	\$1865	\$1929
	<p>Widespread Lavatory Faucet 1/2" valves. 8" centers Spout reach 5.25"</p>				
3120	 	\$1286	\$1608	\$1865	\$1929
	<p>Widespread Lavatory Faucet 1/2" valves. 8" centers Spout reach 5.25"</p>				
2490	 	\$1286	\$1608	\$1865	\$1929
	<p>Widespread Lavatory Faucet 1/2" valves. Spout reach 6.05" 8" centers</p>				
2403	 	\$1168	\$1460	\$1694	\$1752
	<p>Single Hole Lavatory Faucet 6.17" spout height at outlet 5.5" spout reach 9.43" overall height Includes pop-up assembly</p>				
101		\$120	\$157	\$174	\$180
	<p>Cover Plate 6" x 2.5"</p>				



PAVANI

		I	II	III	IV
3103	 <p>Single Hole Lavatory Faucet 6.76" spout height at outlet 5.5" spout reach 10.08" overall height Includes pop-up assembly</p> 	\$1168	\$1460	\$1694	\$1752
101	 <p>Cover Plate 6" x 2-1/2".</p>	\$120	\$157	\$174	\$180
2413	 <p>Single Hole Vessel Faucet 6.25" (15.9cm) spout reach. 10.66" (27.1cm) spout height from base 13.99" overall height Drain not included, see Fittings # 330, 3301, 3302 or 3303</p> 	\$1168	\$1460	\$1694	\$1752
101	 <p>Cover Plate 6" x 2.5".</p>	\$120	\$157	\$174	\$180
2493	 <p>Single Hole Lavatory Faucet 5.65" spout height at outlet 5.58" spout reach 10.48" overall height Includes pop-up assembly</p> 	\$1168	\$1460	\$1694	\$1752
101	 <p>Cover Plate 6" x 2-1/2".</p>	\$120	\$157	\$174	\$180
3-3101	 <p>Wall Mount Lavatory Faucet Spout reach 7.11", 8" centers Drain not included See Fittings #330, 3301, 3302 or 3303</p> <p>VALVE REQUIRED</p> 	\$944	\$1180	\$1369	\$1416
I-532U	2-valve rough with 1/2" NPT inlets & outlet	\$477	—	—	—
3-2481	 <p>Wall Mount Lavatory Faucet Spout reach 7.11", 8" centers Drain not included See Fittings #330, 3301, 3302 or 3303</p> <p>VALVE REQUIRED</p> 	\$944	\$1180	\$1369	\$1416
I-532U	2-valve rough with 1/2" NPT inlets & outlet	\$477	—	—	—

PAVANI

			I	II	III	IV
3-3121		Wall Mount Lavatory Faucet Spout reach 7.25. 8" centers Drain not included See Fittings # 330, 3301, 3302 or 3303 VALVE REQUIRED 	\$944	\$1180	\$1369	\$1416
I-532U		2-valve rough with 1/2" NPT inlets & outlet	\$477	—	—	—
3-2491		Wall Mount Lavatory Faucet Spout reach 7.25. 8" centers. Drain not included See Fittings # 330, 3301, 3302 or 3303 VALVE REQUIRED 	\$944	\$1180	\$1369	\$1416
I-532U		2-valve rough with 1/2" NPT inlets & outlet	\$477	—	—	—
3-3106		Roman Tub Faucet Spout reach 7.92" VALVE REQUIRED	\$1520	\$1900	\$2204	\$2280
I-697		3/4" Valve for above. Quick connect included	\$564	—	—	—
3-2486		Roman Tub Faucet Spout reach 7.92" VALVE REQUIRED	\$1520	\$1900	\$2204	\$2280
I-697		3/4" Valve for above. Quick connect included	\$564	—	—	—
3-3126		Roman Tub Faucet Spout reach 7.15" VALVE REQUIRED	\$1520	\$1900	\$2204	\$2280
I-697		3/4" Valve for above. Quick connect included	\$564	—	—	—
3-2496		Roman Tub Faucet Spout reach 7.15" VALVE REQUIRED	\$1520	\$1900	\$2204	\$2280
I-697		3/4" Valve for above. Quick connect included	\$564	—	—	—



PAVANI

		I	II	III	IV
3-3107	 <p>Roman Tub Faucet with Hand Shower Spout reach 7.92"</p> <p>VALVE REQUIRED</p> 	\$1820	\$2275	\$2639	\$2730
1-698	<p>3/4" valve for above. Includes hose and quick connect</p>	\$1134			
3-2487	 <p>Roman Tub Faucet with Hand Shower Spout reach 7.92"</p> <p>VALVE REQUIRED</p> 	\$1820	\$2275	\$2639	\$2730
1-698	<p>3/4" valve for above. Includes hose and quick connect</p>	\$1134			
3-3127	 <p>Roman Tub Faucet with Hand Shower Spout reach 7.15"</p> <p>VALVE REQUIRED</p> 	\$1820	\$2275	\$2639	\$2730
1-698	<p>3/4" valve for above. Includes hose and quick connect</p>	\$1134			
3-2497	 <p>Roman Tub Faucet with Hand Shower Spout reach 7.15"</p> <p>VALVE REQUIRED</p> 	\$1820	\$2275	\$2639	\$2730
1-698	<p>3/4" valve for above. Includes hose and quick connect</p>	\$1134			
3-3105	 <p>Wall Mount Tub Faucet Spout reach 8-1/4"</p> <p>VALVE REQUIRED</p>	\$1090	\$1363	\$1581	\$1635
1-500U	 <p>2-valve rough with 1/2" NPT inlets & outlet</p>	\$477	—	—	—
3-2485	 <p>Wall Mount Tub Faucet Spout reach 8.25"</p> <p>VALVE REQUIRED</p>	\$1090	\$1363	\$1581	\$1635
1-500U	 <p>2-valve rough with 1/2" NPT inlets & outlet</p>	\$477	—	—	—

PAVANI

			I	II	III	IV
3-3125		Wall Mount Tub Faucet Spout reach 8.25" VALVE REQUIRED	\$1090	\$1363	\$1581	\$1635
I-500U		2-valve rough with 1/2" NPT inlets & outlet	\$477	—	—	—
3-2495		Wall Mount Tub Faucet Spout reach 8.25" VALVE REQUIRED	\$1090	\$1363	\$1581	\$1635
I-500U		2-valve rough with 1/2" NPT inlets & outlet	\$477	—	—	—
2480-4261		Free Standing Tub Filler 38.02" (96.6cm) spout height at outlet (from floor) 8.66" (22.0cm) spout reach 43" overall height 9.25 gallons (35 liters) per minute maximum flow rate (spout) 1.8 gallons (6.8 liters) per minute maximum flow rate (hand shower) 	\$2862	\$3578	\$4150	\$4293
I-339	SEE PAGE 306	Rough for Freestanding Tub Filler For subfloor and concrete floor installations 4.53" overall height 7.20" overall base diameter Universal 3/4" NPT and 1/2" direct sweat connections Test caps included	\$434	—	—	—
280R		Contemporary Hand Shower Set Includes: No. 283-101 Single Function Hand Shower Round No. 284 Braided Hose No. 3-672 Supply Elbow & Holder	\$708	\$885	\$1026	\$1062
3-419		Tub Spout 1/2" NPT inlet fitting 9.15" spout length	\$296	\$370	\$429	\$444
3-615		Tub Spout 1/2" NPT inlet fitting 11.15" spout length	\$366	\$457	\$530	\$548

PAVANI







			I	II	III	IV
3-407		Tub Spout 1/2" NPT inlet fitting 9.15" spout length	\$296	\$370	\$429	\$444
4-3104BP		Balanced Pressure Shower Trim Less showerhead, shower arm	\$829	\$1037	\$1203	\$1244
		VALVE REQUIRED				
1-684		Newport Brass Balanced Pressure Valve, 3 port with service stops, universal 1/2" NPT & direct sweat connections	\$365	—	—	—
		See Shower & Drain Sections to complete shower				
4-2494BP		Balanced Pressure Shower Trim Less showerhead, shower arm	\$780	\$975	\$1131	\$1171
		VALVE REQUIRED				
1-684		Newport Brass Balanced Pressure Valve, 3 port with service stops, universal 1/2" NPT & direct sweat connections	\$365	—	—	—
		See Shower & Drain Sections to complete shower				
5-3102BP		Balanced Pressure Tub & Shower Trim Less tub spout, showerhead, shower arm	\$829	\$1037	\$1203	\$1244
		VALVE REQUIRED				
1-685		Newport Brass Balanced Pressure Valve with diverter, 4 port with service stops, universal 1/2" NPT & direct sweat connections	\$503	—	—	—
		See Shower & Drain Sections to complete shower				
5-2492BP		Balanced Pressure Tub & Shower Trim Less tub spout, showerhead, shower arm	\$889	\$1112	\$1290	\$1334
		VALVE REQUIRED				
1-685		Newport Brass Balanced Pressure Valve with diverter, 4 port with service stops, universal 1/2" NPT & direct sweat connections	\$503	—	—	—
		See Shower & Drain Sections to complete shower				
3-3104BP		Balanced Pressure Shower Set	\$1372	\$1715	\$1990	\$2058
		VALVE REQUIRED				
1-684		Newport Brass Balanced Pressure Valve, 3 port with service stops, universal 1/2" NPT & direct sweat connections	\$365	—	—	—
		See Shower & Drain Sections to complete shower				
3-2484BP		Balanced Pressure Shower Set	\$1372	\$1715	\$1990	\$2058
		VALVE REQUIRED				
1-684		Newport Brass Balanced Pressure Valve, 3 port with service stops, universal 1/2" NPT & direct sweat connections	\$365	—	—	—
		See Shower & Drain Sections to complete shower				

PAVANI

			I	II	III	IV
3-3124BP		Balanced Pressure Shower Set	\$1372	\$1715	\$1990	\$2058
I-684		VALVE REQUIRED Newport Brass Balanced Pressure Valve, 3 port with service stops, universal 1/2" NPT & direct sweat connections	\$365	—	—	—
3-2494BP		Balanced Pressure Shower Set	\$1372	\$1715	\$1990	\$2058
I-684		VALVE REQUIRED Newport Brass Balanced Pressure Valve, 3 port with service stops, universal 1/2" NPT & direct sweat connections	\$365	—	—	—
3-3102BP		Balanced Pressure Tub & Shower Set	\$1442	\$1803	\$2091	\$2163
I-685		VALVE REQUIRED Newport Brass Balanced Pressure Valve with diverter, 4 port with service stops, universal 1/2" NPT & direct sweat connections See Shower & Drain Sections to complete shower	\$503	—	—	—
3-3103TR		1/2" Thermostatic Trim Plate with Handles Integrated diverter handle with independent temperature control VALVE REQUIRED, see page 338	\$786	\$983	\$1140	\$1179
3-2023TR		1/2" Thermostatic Trim Plate with Handles Integrated diverter handle with independent temperature control VALVE REQUIRED, see page 338	\$786	\$983	\$1140	\$1179
3-994LTR		3/4" Thermostatic Trim Plate with Handle	\$639	\$799	\$927	\$959
I-540		VALVE REQUIRED 3/4" Thermostatic Rough-in Valve	\$1020	—	—	—
3-2484TR		3/4" Thermostatic Trim Plate with Handle	\$979	\$1224	\$1420	\$1469
I-540		VALVE REQUIRED 3/4" Thermostatic Rough-in Valve	\$1020	—	—	—

BATH

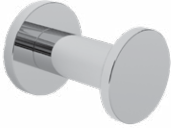
PAVANI

			I	II	III	IV
3-549		Diverter/Flow Control Trim Use with stop or diverter valves, see page 347-348	\$287	\$359	\$416	\$431
3-608		Diverter/Flow Control Trim Use with stop or diverter valves, see page 347-348	\$275	\$344	\$399	\$413
2489		Bidet Set 1/2" valves Includes bottom spray with vacuum breaker. 4 hole mount bidet See page 330 for complete Bidet offering	\$1725	\$2156	\$2501	\$2587
36-09		Towel Ring	\$392	\$490	\$568	\$587
36-01		18" Towel Bar	\$272	\$340	\$394	\$408
36-02		24" Towel Bar	\$333	\$416	\$483	\$499
36-12		Single Robe Hook	\$107	\$134	\$155	\$161
36-13		Double Robe Hook	\$199	\$248	\$288	\$298
36-27		Open Toilet Tissue Holder	\$273	\$341	\$396	\$409

PAVANI

			I	II	III	IV
36-28		Double Post Toilet Tissue Holder Pivoting Arm	\$316	\$394	\$457	\$473

Coordinating Grab Bars starting on page 358













SEAPORT



SEAPORT

			I	II	III	IV
850		Widespread Lavatory Faucet 1/2" valves. Spout reach 4.75" 8" centers	\$1214	\$1518	\$1761	\$1821
						
850c		Widespread Lavatory Faucet 1/2" valves. Spout reach 6.12" 8" centers	\$1357	\$1697	\$1968	\$2036
						
1740		Widespread Lavatory Faucet 1/2" valves. Spout reach 6.11". 8" centers	\$1571	\$1964	\$2278	\$2357
						
3-856c		Roman Tub Faucet Spout reach 9.44"	\$1520	\$1900	\$2204	\$2280
		VALVE REQUIRED				
I-506		3/4" valves for above. Quick connect included	\$564	—	—	—
3-1746		Roman Tub Faucet Spout reach 9.44"	\$1836	\$2295	\$2663	\$2754
		VALVE REQUIRED				
I-506		3/4" valves for above. Quick connect included	\$564	—	—	—
3-857c		Roman Tub Faucet with Hand Shower Set Spout reach 9.44"	\$1820	\$2275	\$2639	\$2730
		VALVE REQUIRED				
I-507		3/4" valve for above Includes hose and quick connect	\$1134	—	—	—
3-1747		Roman Tub Faucet with Hand Shower Spout reach 9.44"	\$2136	\$2670	\$3098	\$3204
		VALVE REQUIRED				
I-507		3/4" valve for above Includes hose and quick connect	\$1134	—	—	—
						







SEAPORT

			I	II	III	IV
3-855		Wall Mount Tub Faucet VALVE REQUIRED	\$1090	\$1363	\$1581	\$1635
1-500U		2-valve rough with 1/2" NPT inlets & outlet	\$477	—	—	—
2201		Tub Spout 1/2" NPT inlet fitting 6.71" spout length	\$262	\$333	\$395	\$400
2-564		Tub Spout 3/4" NPT inlet (1/2" bushing included) 7.43" spout length	\$312	\$390	\$453	\$468
4-854BP		Balanced Pressure Shower Trim Less showerhead, shower arm VALVE REQUIRED	\$704	\$880	\$1021	\$1056
1-684		Newport Brass Balanced Pressure Valve, 3 port with service stops, universal 1/2" NPT & direct sweat connections See Shower & Drain Sections to complete shower.	\$365	—	—	—
4-1744BP		Balanced Pressure Shower Trim Set Less showerhead, shower arm VALVE REQUIRED	\$704	\$917	\$1045	\$1056
1-684		Newport Brass Balanced Pressure Valve, 3 port with service stops, universal 1/2" NPT & direct sweat connections See Shower & Drain Sections to complete shower.	\$365	—	—	—
5-852BP		Balanced Pressure Tub & Shower Trim Less tub spout, showerhead, shower arm VALVE REQUIRED	\$794	\$993	\$1152	\$1191
1-685		Newport Brass Balanced Pressure Valve with diverter, 4 port with service stops, universal 1/2" NPT & direct sweat connections See Shower & Drain Sections to complete shower	\$503	—	—	—
5-1742BP		Balanced Pressure Tub & Shower Trim Set Less tub spout, showerhead, shower arm VALVE REQUIRED	\$806	\$1048	\$1207	\$1207
1-685		Newport Brass Balanced Pressure Valve with diverter, 4 port with service stops, universal 1/2" NPT & direct sweat connections See Shower & Drain Sections to complete shower	\$503	—	—	—

SEAPORT

			I	II	III	IV
3-1663TR		1/2" Thermostatic Trim Plate with Handles Integrated diverter handle with independent temperature control. VALVE REQUIRED, see page 338	\$786	\$983	\$1140	\$1179
3-803TR		1/2" Thermostatic Trim Plate with Handles Integrated diverter handle with independent temperature control. VALVE REQUIRED, see page 338	\$786	\$983	\$1140	\$1179
3-1744TR		3/4" Thermostatic Trim Plate with Handle VALVE REQUIRED	\$639	\$799	\$927	\$959
I-540		3/4" Thermostatic Rough-in Valve	\$1020	—	—	—
3-804TR		3/4" Thermostatic Trim Plate with Handle Extends 1-3/8". Specify finish VALVE REQUIRED	\$639	\$799	\$927	\$959
I-540		3/4" Thermostatic Rough-in Valve	\$1020	—	—	—
3-202		Diverter/Flow Control Trim Use with stop or diverter valves, see page 347-348	\$260	\$335	\$400	\$400
3-289		Diverter/Flow Control Trim Use with stop or diverter valves, see page 347-348	\$475	\$593	\$704	\$712
890-1410		Towel Ring	\$197	\$246	\$285	\$295
890-1400		Towel Ring - Open	\$246	\$307	\$356	\$368

SEAPORT

		I	II	III	IV
890-1230	18" Towel Bar	\$264	\$330	\$383	\$396
890-1250	24" Towel Bar	\$309	\$387	\$449	\$464
					
890-1650	Single Robe Hook	\$87	\$108	\$125	\$130
					
890-1660	Double Robe Hook	\$176	\$220	\$255	\$264
					
890-1510	Hanging Toilet Tissue Holder	\$246	\$307	\$356	\$368
					
890-1500	Double Post Toilet Tissue Holder	\$289	\$362	\$420	\$434
					
2-116	Tank Lever for Seaport Series	\$96	\$121	\$207	\$207
6-505	Tank Lever Mechanism	\$139	\$174	\$201	\$208
					
2-470	Tank Lever for Seaport Series	\$272	\$340	\$394	\$408
6-505	Tank Lever Mechanism	\$139	\$174	\$201	\$208
					

Coordinating Grab Bars starting on page 358 and Baskets starting on page 354



Secant Widespread Lavatory Faucet in Satin Bronze (10) (see page 256)

SECANT



SECANT

		I	II	III	IV
2560	 <p>Widespread Lavatory Faucet Lever Handles. 1/2" valves Spout reach 5.47". 8" centers</p> 	\$1357	\$1697	\$1968	\$2036
2540	 <p>Widespread Lavatory Faucet Triple-deck-plate. 8" centers Spout reach 5.47". 1/2" valves</p> 	\$1500	\$1875	\$2175	\$2250
2990	 <p>Widespread Lavatory Faucet Cross Handles. 1/2" valves Spout reach 5.47". 8" centers</p> 	\$1357	\$1697	\$1968	\$2036
2560c	 <p>Widespread Lavatory Faucet Lever Handles. 1/2" valves Spout reach 5.49". 8" centers</p> 	\$1500	\$1875	\$2175	\$2250
2990c	 <p>Widespread Lavatory Faucet Cross Handles. 1/2" valves Spout reach 5.49". 8" centers</p> 	\$1500	\$1875	\$2175	\$2250
2040	 <p>Widespread Lavatory Faucet Lever Handles. 1/2" valves Spout reach 5.81". 8" centers</p> 	\$1500	\$1875	\$2175	\$2250
2060	 <p>Widespread Lavatory Faucet Cross Handles. 1/2" valves Spout reach 5.81". 8" centers</p> 	\$1500	\$1875	\$2175	\$2250

SECANT

		I	II	III	IV
2563	 <p>Single Hole Lavatory Faucet 5.15" spout height at outlet 4.94" spout reach 8.70" overall height Includes pop-up assembly</p> 	\$1168	\$1460	\$1694	\$1752
101	 <p>Cover Plate 6" x 2.5"</p>	\$120	\$157	\$174	\$180
2043-1	 <p>Single Hole Lavatory Faucet 6.84" spout height at outlet 5.43" spout reach 9.70" overall height Includes pop-up assembly</p> 	\$1168	\$1460	\$1694	\$1752
2043	 <p>Single Hole Lavatory Faucet 7.40" spout height at outlet 6.38" spout reach 11.50" overall height Includes pop-up assembly</p> 	\$1268	\$1625	\$1865	\$1902
3-2561	 <p>Wall Mount Lavatory Faucet Lever Handles. Spout reach 8.32" 8" centers. Drain not included. See Fittings #330, 3301, 3302 or 3303</p> <p>VALVE REQUIRED</p> 	\$1163	\$1454	\$1687	\$1745
I-532U	<p>2-valve rough with 1/2" NPT inlets & outlet</p>	\$477	—	—	—
3-2541	 <p>Wall Mount Lavatory Faucet Spout reach 8.32". 8" centers Drain not included See Fittings # 330, 3301, 3302 or 3303</p> <p>VALVE REQUIRED</p> 	\$1163	\$1454	\$1687	\$1745
I-532U	<p>2-valve rough with 1/2" NPT inlets & outlet</p>	\$477	—	—	—

SECANT

		I	II	III	IV
3-2041	 <p>Wall Mount Lavatory Faucet Lever Handles. Spout reach 9.40" 8" centers. Drain not included. See Fittings #330, 3301, 3302 or 3303</p> <p>VALVE REQUIRED</p> 	\$1163	\$1454	\$1687	\$1745
I-532U	2-valve rough with 1/2" NPT inlets & outlet	\$477	—	—	—
3-2061	 <p>Wall Mount Lavatory Faucet Lever Handles. Spout reach 9.40" 8" centers. Drain not included. See Fittings #330, 3301, 3302 or 3303</p> <p>VALVE REQUIRED</p> 	\$1163	\$1454	\$1687	\$1745
I-532U	2-valve rough with 1/2" NPT inlets & outlet	\$477	—	—	—
3-2566	 <p>Roman Tub Faucet with Lever Handles Spout reach 8.35" Finished deck thickness should be less than or equal to 15/16"</p> <p>VALVE REQUIRED</p>	\$1836	\$2295	\$2663	\$2754
I-665	3/4" valve for above Quick connect included	\$564	—	—	—
3-2546	 <p>Roman Tub Faucet Spout reach 8.35". Finished deck thickness should be less than or equal to 15/16"</p> <p>VALVE REQUIRED</p>	\$1836	\$2295	\$2663	\$2754
I-665	3/4" valve for above Quick connect included	\$564	—	—	—
3-2046	 <p>Roman Tub Faucet Spout reach 8".</p> <p>VALVE REQUIRED</p>	\$1520	\$1900	\$2204	\$2280
I-665	3/4" valve for above Quick connect included	\$564	—	—	—
3-2567	 <p>Roman Tub Faucet with Hand Shower Spout reach 8.35" Finished deck thickness should be less than or equal to 15/16" Set includes: 1 ea. No. 283-4 Hand Shower, No 284 59" Hose, No. 6-289-4 Deck Flange Kit</p> <p>VALVE REQUIRED</p> 	\$2136	\$3223	\$3844	\$4025
I-666	3/4" valve for above Includes hose & quick connect	\$1134	—	—	—

SECANT

		I	II	III	IV
3-2547	 <p>Roman Tub Faucet with Hand Shower Spout reach 8.35" Finished deck thickness should be less than or equal to 15/16"</p> <p>VALVE REQUIRED</p> 	\$2136	\$3223	\$3844	\$4035
1-666	<p>3/4" valve for above Includes hose & quick connect</p>	\$1134	—	—	—
3-2047	 <p>Roman Tub Faucet with Hand Shower Spout reach 8.00"</p> <p>VALVE REQUIRED</p> 	\$1820	\$2275	\$2639	\$2730
1-666	<p>3/4" valve for above Includes hose & quick connect</p>	\$1134	—	—	—
3-2565	 <p>Wall Mount Tub Faucet Lever Handles</p> <p>VALVE REQUIRED</p>	\$1090	\$1369	\$1581	\$1635
1-500U	 <p>2-valve rough with 1/2" NPT inlets & outlet</p>	\$477	—	—	—
3-2545	 <p>Wall Mount Tub Faucet Spout reach 8"</p> <p>VALVE REQUIRED</p>	\$1090	\$1371	\$1581	\$1635
1-500U	 <p>2-valve rough with 1/2" NPT inlets & outlet</p>	\$477	—	—	—
3-2045	 <p>Wall Mount Tub Faucet</p> <p>VALVE REQUIRED</p>	\$1090	\$1363	\$1581	\$1635
1-500U	 <p>2-valve rough with 1/2" NPT inlets & outlet</p>	\$477	—	—	—
2560-4261	 <p>Free Standing Tub Filler 38.02" (96.6cm) spout height at outlet (from floor) 7.86" (22.0cm) spout reach 39.49" overall height 9.25 gallons (35 liters) per minute maximum flow rate (spout) 1.8 gallons (6.8 liters) per minute maximum flow rate (hand shower)</p> 	\$2862	\$3578	\$4150	\$4293
1-339	<p>Rough for Freestanding Tub Filler For subfloor and concrete floor installations 4.53" overall height 7.20" overall base diameter Universal 3/4" NPT and 1/2" direct sweat connections Test caps included</p>	\$434	—	—	—

SEE PAGE 306

SECANT

			I	II	III	IV
2040-4261		Free Standing Tub Filler 37.99" (96.5cm) spout height at outlet (from floor) 8.66" (22.0cm) spout reach 43" overall height 9.25 gallons (35 liters) per minute maximum flow rate (spout) 1.8 gallons (6.8 liters) per minute maximum flow rate (hand shower)	\$2862	\$3578	\$4150	\$4293
I-339	SEE PAGE 305	Rough for Freestanding Tub Filler For subfloor and concrete floor installations 4.53" overall height 7.20" overall base diameter Universal 3/4" NPT and 1/2" direct sweat connections Test caps included	\$434	—	—	—
280P		Contemporary Hand Shower Set Includes: No. 283-102 Single Function Hand Shower Square No. 284 Braided Hose No. 3-671 Supply Elbow & Holder	\$708	\$885	\$1026	\$1062
8-030		Tub Spout 3/4" NPT inlet fitting 9.44" spout length	\$474	\$592	\$686	\$710
3-328		Tub Spout 1/2" NPT inlet fitting 6.94" spout length	\$296	\$370	\$429	\$444
4-2044BP		Balanced Pressure Shower Trim Less showerhead, shower arm	\$780	\$975	\$1131	\$1170
I-684		VALVE REQUIRED Newport Brass Balanced Pressure Valve, 3 port with service stops, universal 1/2" NPT & direct sweat connections See Shower & Drain Sections to complete shower.	\$365	—	—	—
4-2544BP		Balanced Pressure Shower Trim Less showerhead, shower arm	\$780	\$1016	\$1171	\$1171
I-684		VALVE REQUIRED Newport Brass Balanced Pressure Valve, 3 port with service stops, universal 1/2" NPT & direct sweat connections See Shower & Drain Sections to complete shower.	\$365	—	—	—







SECANT

			I	II	III	IV
4-2064BP		Balanced Pressure Shower Trim Less showerhead, shower arm	\$780	\$975	\$1131	\$1170
I-684		VALVE REQUIRED Newport Brass Balanced Pressure Valve, 3 port with service stops, universal 1/2" NPT & direct sweat connections See Shower & Drain Sections to complete shower.	\$365	—	—	—
5-2042BP		Balanced Pressure Tub & Shower Trim Less tub spout, showerhead, shower arm	\$889	\$1112	\$1290	\$1334
I-685		VALVE REQUIRED Newport Brass Balanced Pressure Valve with diverter, 4 port with service stops, universal 1/2" NPT & direct sweat connections See Shower & Drain Sections to complete shower	\$503	—	—	—
5-2542BP		Balanced Pressure Tub & Shower Trim Less tub spout, showerhead, shower arm	\$879	\$1144	\$1321	\$1321
I-685		VALVE REQUIRED Newport Brass Balanced Pressure Valve with diverter, 4 port with service stops, universal 1/2" NPT & direct sweat connections See Shower & Drain Sections to complete shower	\$503	—	—	—
5-2062BP		Balanced Pressure Tub & Shower Trim Less tub spout, showerhead, shower arm	\$889	\$1112	\$1290	\$1334
I-685		VALVE REQUIRED Newport Brass Balanced Pressure Valve with diverter, 4 port with service stops, universal 1/2" NPT & direct sweat connections See Shower & Drain Sections to complete shower	\$503	—	—	—
3-2564BP		Balanced Pressure Shower Set	\$1372	\$1856	\$2134	\$2225
I-684		VALVE REQUIRED Newport Brass Balanced Pressure Valve, 3 port with service stops, universal 1/2" NPT & direct sweat connections	\$365	—	—	—
3-2544BP		Balanced Pressure Shower Set	\$1372	\$1856	\$2134	\$2225
I-684		VALVE REQUIRED Newport Brass Balanced Pressure Valve, 3 port with service stops, universal 1/2" NPT & direct sweat connections	\$365	—	—	—
3-2044BP		Balanced Pressure Shower Set	\$1372	\$1715	\$1990	\$2058
I-684		VALVE REQUIRED Newport Brass Balanced Pressure Valve, 3 port with service stops, universal 1/2" NPT & direct sweat connections	\$365	—	—	—

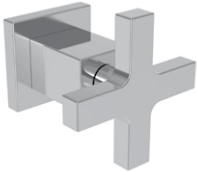

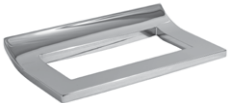



SECANT

			I	II	III	IV
3-2023TS		1/2" Thermostatic Trim Plate with Handles Integrated diverter handle with independent temperature control VALVE REQUIRED, see page 338	\$786	\$983	\$1140	\$1179
3-2063TS		1/2" Thermostatic Trim Plate with Handles Integrated diverter handle with independent temperature control VALVE REQUIRED, see page 338	\$786	\$983	\$1140	\$1179
3-2044TS		3/4" Thermostatic Trim Plate with Handle VALVE REQUIRED	\$831	\$1039	\$1205	\$1247
I-54°		3/4" Thermostatic Rough-in Valve	\$1020	—	—	—
3-2544TS		3/4" Thermostatic Trim Plate with Handle VALVE REQUIRED	\$831	\$1067	\$1205	\$1247
I-54°		3/4" Thermostatic Rough-in Valve	\$1020	—	—	—
3-2064TS		3/4" Thermostatic Trim Plate with Handle VALVE REQUIRED	\$831	\$1039	\$1205	\$1247
I-54°		3/4" Thermostatic Rough-in Valve	\$1020	—	—	—
3-368		Diverter/Flow Control Trim Use with stop or diverter valves, see page 347-348	\$286	\$357	\$415	\$429
3-609		Diverter/Flow Control Trim Use with stop or diverter valves, see page 347-348	\$296	\$370	\$429	\$444

SECANT

		I	II	III	IV	
3-577		Diverter/Flow Control Trim Use with stop or diverter valves, see page 347-348	\$286	\$357	\$415	\$429
2049		Bidet Set Lever Handles. 1/2" valves. Includes bottom spray with vacuum breaker; 4 hole mount bidet See page 330 for complete Bidet offering	\$1798	\$2247	\$2607	\$2697
2489		Bidet Set 1/2" valves Includes bottom spray with vacuum breaker. 4 hole mount bidet See page 330 for complete Bidet offering	\$1725	\$2156	\$2501	\$2587
2020-1200		8" Towel Bar	\$235	\$294	\$341	\$353
37-09		8" Towel Ring	\$327	\$409	\$475	\$491
2540-1410		Towel Ring	\$299	\$374	\$434	\$448
2020-1230		18" Towel Bar	\$276	\$345	\$400	\$414
2020-1250		24" Towel Bar	\$324	\$405	\$470	\$486
37-02		24" Towel Bar	\$365	\$456	\$544	\$547
2540-1250		24" Towel Bar	\$439	\$548	\$636	\$658

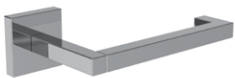
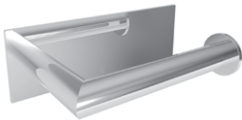
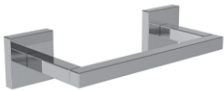
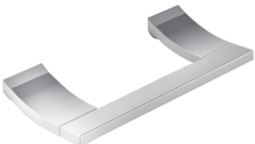
SECANT

			I	II	III	IV
2020-1650		Single Robe Hook	\$120	\$150	\$174	\$180
37-12		Single Robe Hook	\$139	\$174	\$201	\$208
2540-1650		Single Robe Hook	\$143	\$179	\$208	\$215
2540-1660		Double Robe Hook	\$212	\$265	\$307	\$318
2020-1570		Open Toilet Tissue Holder	\$263	\$329	\$381	\$395
2540-1570		Open Toilet Tissue Holder, Right	\$246	\$307	\$356	\$368
2020-1500		Double Post Toilet Tissue Holder	\$308	\$385	\$446	\$462
37-28		Double Post Toilet Tissue Holder Pivoting Arm	\$334	\$417	\$484	\$501
2540-1500		Double Post Toilet Tissue Holder	\$322	\$402	\$467	\$483

BATH

Coordinating Grab Bars starting on page 358 and Baskets starting on page 354





TAFT









TAFT

		I	II	III	IV
2940	 <p>Widespread Lavatory Faucet 1/2" valves. 6.01" centers Spout reach 6.01"</p> 	\$1357	\$1697	\$1968	\$2036
2940CS	 <p>Widespread Lavatory 1/2" valves. 8" centers Spout reach 6.25"</p> 	\$1357	\$1697	\$1968	\$2036
2940C	 <p>Widespread Lavatory 1/2" valves. 8" centers Spout reach 7.13"</p> 	\$1357	\$1697	\$2063	\$2063
3-2941	 <p>Wall Mount Lavatory Faucet Spout reach 9.50". 8" centers Drain not included See Fittings #330, 3301, 3302 or 3303</p> <p>VALVE REQUIRED</p> 	\$1163	\$1454	\$1687	\$1700
I-532U	<p>2-valve rough with 1/2" NPT inlets & outlet</p>	\$477	—	—	—
3-2946	 <p>Roman Tub Faucet Spout reach 8.25"</p> <p>VALVE REQUIRED</p>	\$1520	\$1915	\$2204	\$2280
I-697	 <p>3/4" Valve for above. Quick connect included</p>	\$564	—	—	—
3-2947	 <p>Roman Tub Faucet with Hand Shower Spout reach 8.25"</p> <p>VALVE REQUIRED</p>	\$1820	\$2409	\$2838	\$2950
I-698	 <p>3/4" valve for above. Includes hose and quick connect</p> 	\$1134	—	—	—

TAFT

			I	II	III	IV
3-2945		Wall Mount Tub Faucet Spout reach 9.50"	\$1090	\$1363	\$1581	\$1635
		VALVE REQUIRED				
I-500U		2-valve rough with 1/2" NPT inlets & outlet	\$477	—	—	—
2940-4261		Free Standing Tub Filler 37.22" (94.5cm) spout height at outlet (from floor) 8.73" (22.2cm) spout reach 43.31" overall height 12 gallons (45.41 liters) per minute maximum flow rate (spout) 1.8 gallons (6.8 liters) per minute maximum flow rate (hand shower)	\$2862	\$3578	\$4150	\$4293
						
I-339	 SEE PAGE 307	Rough for Freestanding Tub Filler For subfloor and concrete floor installations 4.53" overall height 7.20" overall base diameter Universal 3/4" NPT and 1/2" direct sweat connections Test caps included	\$434	—	—	—
3-729		Tub Spout 1/2" NPT inlet fitting 9.94" spout length	\$361	\$451	\$524	\$542
4-2944BP		Balanced Pressure Shower Trim Plate with Handle Less showerhead, shower arm	\$704	\$880	\$1021	\$1056
		VALVE REQUIRED				
I-684		Newport Brass Balanced Pressure Valve, 3 port with service stops, universal 1/2" NPT & direct sweat connections See Shower & Drain Sections to complete shower	\$365	—	—	—
5-2942BP		Balanced Pressure Tub & Shower Trim Less tub spout, showerhead, shower arm	\$794	\$993	\$1152	\$1191
		VALVE REQUIRED				
I-685		Newport Brass Balanced Pressure Valve with diverter, 4 port with service stops, universal 1/2" NPT & direct sweat connections See Shower & Drain Sections to complete shower	\$503	—	—	—
3-2943TR		1/2" Thermostatic Trim Plate with Handles Integrated diverter handle with independent temperature control VALVE REQUIRED, see page 338	\$913	\$1142	\$1324	\$1370

TAFT

			I	II	III	IV
3-2944TR		3/4" Thermostatic Trim Plate with Handle	\$979	\$1224	\$1420	\$1469
I-540		VALVE REQUIRED 3/4" Thermostatic Rough-in Valve	\$1020	—	—	—
3-727		3/4" Diverter/Flow Control Trim Use with stop or diverter valves, see page 347-348	\$257	\$329	\$412	\$412
1600-1200		8" Towel Bar	\$230	\$288	\$334	\$345
1600-1230		18" Towel Bar	\$260	\$325	\$377	\$390
1600-1250		24" Towel Bar	\$300	\$375	\$435	\$450
1600-1660		Double Robe Hook	\$150	\$188	\$218	\$225
1600-1500		Double Post Toilet Tissue Holder	\$300	\$375	\$435	\$450

Coordinating Grab Bars starting on page 358

TOLMIN









TOLMIN

			I	II	III	IV
3320		<p>Widespread Lavatory Faucet Lever Handles. 1/2" valves. 8" centers Spout reach 6.01"</p> 	\$1357	\$1697	\$1968	\$2036
3330		<p>Widespread Lavatory Faucet Cross Handles. 1/2" valves. 8" centers Spout reach 6.01"</p> 	\$1357	\$1697	\$1968	\$2036
3320C		<p>Widespread Lavatory Faucet Lever Handles. 1/2" valves. 8" centers Spout reach 7.13"</p> 	\$1357	\$1697	\$2000	\$2036
3330C		<p>Widespread Lavatory Faucet Cross Handles. 1/2" valves. 8" centers Spout reach 7.13"</p> 	\$1357	\$1697	\$2000	\$2036
3400		<p>Widespread Lavatory Faucet 1/2" valves. 8" centers Spout reach 5.54"</p> 	\$1357	\$1697	\$1968	\$2036
3410		<p>Widespread Lavatory Faucet 1/2" valves. 8" centers Spout reach 5.54"</p> 	\$1357	\$1697	\$1968	\$2036
3380		<p>Widespread Lavatory Faucet 1/2" valves. 8" centers Spout reach 5.25"</p> 	\$1357	\$1697	\$1968	\$2036

TOLMIN

			I	II	III	IV
3390		Widespread Lavatory Faucet 1/2" valves. 8" centers Spout reach 5.25"	\$1357	\$1697	\$1968	\$2036
						
3-3321		Wall Mount Lavatory Faucet Lever Handles. Spout reach 9.50" 8" centers. Drain not included See Fittings #330, 3301, 3302 or 3303	\$944	\$1223	\$1528	\$1528
		VALVE REQUIRED				
I-532U		2-valve rough with 1/2" NPT inlets & outlet	\$477	—	—	—
3-3331		Wall Mount Lavatory Faucet Cross Handles. Spout reach 9.50" 8" centers. Drain not included See Fittings #330, 3301, 3302 or 3303	\$944	\$1223	\$1528	\$1528
		VALVE REQUIRED				
I-532U		2-valve rough with 1/2" NPT inlets & outlet	\$477	—	—	—
3-3326		Roman Tub Faucet Lever Handles. Spout reach 8.25"	\$1836	\$2295	\$2663	\$2754
		VALVE REQUIRED				
I-697		3/4" Valve for above. Quick connect included	\$564	—	—	—
3-3327		Roman Tub Faucet with Hand Shower Lever Handles. Spout reach 8.25"	\$2136	\$2670	\$3098	\$3204
		VALVE REQUIRED				
I-698		3/4" valve for above. Includes hose and quick connect	\$1134	—	—	—
3-3325		Wall Mount Tub Faucet Lever Handles. Spout reach 9.50"	\$1090	\$1363	\$1581	\$1635
		VALVE REQUIRED				
I-500U		2-valve rough with 1/2" NPT inlets & outlet	\$477	—	—	—

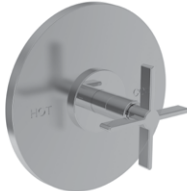
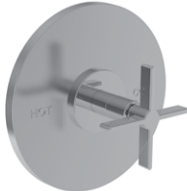
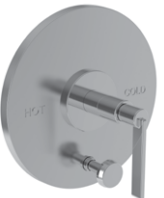
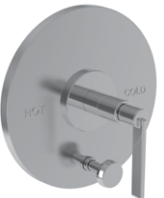
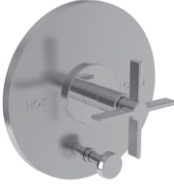
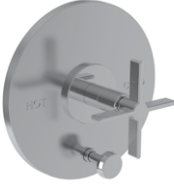
TOLMIN



			I	II	III	IV
3-3335		Wall Mount Tub Faucet Cross Handles. Spout reach 9.50" VALVE REQUIRED	\$1090	\$1363	\$1581	\$1635
1-500U		2-valve rough with 1/2" NPT inlets & outlet	\$477	—	—	—
3-724		Tub Spout 1/2" NPT inlet fitting 9.50" spout length	\$361	\$451	\$524	\$542
4-3324BP		Balanced Pressure Shower Trim Plate with Handle Lever Handle Less showerhead, shower arm VALVE REQUIRED	\$780	\$975	\$1131	\$1170
1-684		Newport Brass Balanced Pressure Valve, 3 port with service stops, universal 1/2" NPT & direct sweat connections See Shower & Drain Sections to complete shower.	\$365	—	—	—
4-3334BP		Balanced Pressure Shower Trim Plate with Handle Cross Handle Less showerhead, shower arm VALVE REQUIRED	\$780	\$975	\$1131	\$1170
1-684		Newport Brass Balanced Pressure Valve, 3 port with service stops, universal 1/2" NPT & direct sweat connections See Shower & Drain Sections to complete shower.	\$365	—	—	—
5-3322BP		Balanced Pressure Tub and Shower Trim with Lever Handle Less tub spout, showerhead, shower arm VALVE REQUIRED	\$889	\$1112	\$1290	\$1334
1-685		Newport Brass Balanced Pressure Valve with diverter, 4 port with service stops, universal 1/2" NPT & direct sweat connections See Shower & Drain Sections to complete shower	\$503	—	—	—
5-3332BP		Balanced Pressure Tub and Shower Trim with Cross Handle Less tub spout, showerhead, shower arm VALVE REQUIRED	\$889	\$1112	\$1290	\$1334
1-685		Newport Brass Balanced Pressure Valve with diverter, 4 port with service stops, universal 1/2" NPT & direct sweat connections See Shower & Drain Sections to complete shower	\$503	—	—	—
3-3323TR		1/2" Thermostatic Trim Plate with Lever Handle Integrated diverter handle with independent temperature control VALVE REQUIRED, see page 338	\$913	\$1142	\$1324	\$1370

BATH

TOLMIN

		I	II	III	IV	
3-3333TR		1/2" Thermostatic Trim Plate with Cross Handle Integrated diverter handle with independent temperature control VALVE REQUIRED, see page 338	\$913	\$1142	\$1324	\$1370
3-3324TR		3/4" Thermostatic Trim Plate with Lever Handle VALVE REQUIRED	\$831	\$1039	\$1205	\$1247
I-54°		3/4" Thermostatic Rough-in Valve	\$1020	—	—	—
3-3334TR		3/4" Thermostatic Trim Plate with Lever Handle VALVE REQUIRED	\$831	\$1039	\$1205	\$1247
I-54°		3/4" Thermostatic Rough-in Valve	\$1020	—	—	—
3-721		Diverter/Flow Control Trim Lever Handle Use with stop or diverter valves, see page 347-348	\$257	\$329	\$412	\$412
3-722		Diverter/Flow Control Trim Cross Handle Use with stop or diverter valves, see page 347-348	\$257	\$329	\$412	\$412
990-1200		8" Towel Bar	\$233	\$292	\$338	\$350
990-1230		18" Towel Bar	\$275	\$344	\$399	\$413
990-1250		24" Towel Bar	\$295	\$369	\$428	\$443
990-1650		Single Robe Hook	\$101	\$127	\$147	\$152

TOLMIN

			I	II	III	IV
990-1660		Robe Hook	\$133	\$167	\$193	\$200
990-1570		Open Toilet Tissue Holder	\$169	\$212	\$246	\$254
990-1500		Double Post Toilet Tissue Holder	\$275	\$344	\$399	\$449

Coordinating Grab Bars starting on page 358









VANDER



VANDER

			I	II	III	IV
2910		Widespread Lavatory Faucet Lever Handles. 1/2" valves. Spout reach 5.82" 8" centers	\$1500	\$1875	\$2175	\$2250
						
3-2916		Roman Tub Faucet with Lever Handles Spout reach 9.12"	\$1836	\$2295	\$2663	\$2754
1-665		VALVE REQUIRED 3/4" valve for above Quick connect included	\$564	—	—	—
3-2917		Roman Tub Faucet with Hand Shower Lever Handles. Spout reach 9.12"	\$2136	\$2692	\$3098	\$3204
		VALVE REQUIRED 				
1-666		3/4" valve for above Includes hose & quick connect	\$1134	—	—	—
3-2915		Wall Mount Tub Faucet with Lever Handles Spout reach 6.05"	\$1090	\$1363	\$1581	\$1635
1-500U		VALVE REQUIRED 2-valve rough with 1/2" NPT inlets & outlet	\$477	—	—	—
20-131		Tub Spout 1/2" NPT inlet fitting 6.71" spout length	\$289	\$369	\$421	\$434
4-2914BP		Balanced Pressure Shower Trim with Lever Handle Less showerhead, shower arm	\$780	\$975	\$1131	\$1171
1-684		VALVE REQUIRED Newport Brass Balanced Pressure Valve, 3 port with service stops, universal 1/2" NPT & direct sweat connections See Shower & Drain Sections to complete shower.	\$365	—	—	—
5-2912BP		Balanced Pressure Shower Trim with Lever Handle Less tub spout, showerhead, shower arm	\$879	\$1099	\$1275	\$1319
1-685		VALVE REQUIRED Newport Brass Balanced Pressure Valve with diverter, 4 port with service stops, universal 1/2" NPT & direct sweat connections See Shower & Drain Sections to complete shower	\$503	—	—	—

VANDER

			I	II	III	IV
3-2913TR		1/2" Thermostatic Trim Plate with Handles Integrated diverter handle with independent temperature control VALVE REQUIRED, see page 338	\$913	\$1142	\$1324	\$1370
3-2914TR		3/4" Thermostatic Trim Plate with Lever Handle VALVE REQUIRED	\$831	\$1081	\$1242	\$1247
I-540		3/4" Thermostatic Rough-in Valve	\$1020	—	—	—
3-561		Diverter/Flow Control Trim Lever Handle Use with stop or diverter valves, see page 347-348	\$318	\$397	\$460	\$476
40-10		Open Towel Ring	\$260	\$325	\$377	\$390
40-02		24" Towel Bar	\$318	\$397	\$464	\$476
40-13		Double Robe Hook	\$297	\$371	\$430	\$445
40-28		Double Post Toilet Tissue Holder	\$297	\$371	\$431	\$445

Coordinating Grab Bars starting on page 358



Victoria Wall Mount Lavatory Faucet in Unlacquered Brass (03N) (see page 282)

VICTORIA











VICTORIA

		I	II	III	IV
1770	 <p>Widespread Lavatory Faucet Lever Handles. 1/2" valves Spout reach 5.93". 8" centers</p> 	\$1357	\$1697	\$1968	\$2036
1760	 <p>Widespread Lavatory Faucet Cross Handles. 1/2" valves. Spout reach 5.93" 8" centers</p> 	\$1357	\$1697	\$1968	\$2036
3-1771	 <p>Wall Mount Lavatory Faucet Lever Handles. Spout reach 7.70". 8" centers Drain not included See Fittings # 330, 3301, 3302 or 3303</p> <p>VALVE REQUIRED</p> 	\$944	\$1180	\$1369	\$1416
I-532U	<p>2-valve rough with 1/2" NPT inlets & outlet</p>	\$477	—	—	—
3-1761	 <p>Wall Mount Lavatory Faucet Cross Handles. Spout reach 7.70". 8" centers Drain not included For sink drain to use with No. 9301 See Fittings # 330, 3301, 3302 or 3303</p> <p>VALVE REQUIRED</p> 	\$944	\$1180	\$1369	\$1416
I-532U	<p>2-valve rough with 1/2" NPT inlets & outlet</p>	\$477	—	—	—
3-1776	 <p>Roman Tub Faucet Lever Handles. Spout reach 8.40"</p> <p>VALVE REQUIRED</p>	\$1836	\$2295	\$2663	\$2754
I-586	 <p>3/4" valve only for above Quick connect included</p>	\$564	—	—	—
3-1766	 <p>Roman Tub Faucet Cross Handles. Spout reach 8.40"</p> <p>VALVE REQUIRED</p>	\$1836	\$2295	\$2663	\$2754
I-586	 <p>3/4" valve only for above Quick connect included</p>	\$564	—	—	—











VICTORIA

		I	II	III	IV
3-1777	 <p>Roman Tub Faucet with Hand Shower Lever Handles. Spout 8.40" Spout reach 11"</p> <p>VALVE REQUIRED</p> 	\$2136	\$2670	\$3098	\$3204
1-587	<p>3/4" valve for above Includes hose & quick connect</p>	\$1134	—	—	—
3-1767	 <p>Roman Tub Faucet with Hand Shower Cross Handles. Spout reach 8.40"</p> <p>VALVE REQUIRED</p> 	\$2136	\$2670	\$3098	\$3204
1-587	<p>3/4" valve for above Includes hose & quick connect</p>	\$1134	—	—	—
3-1775	 <p>Wall Mount Tub Faucet Lever Handles. Spout reach 8.87"</p> <p>VALVE REQUIRED</p>	\$1090	\$1363	\$1581	\$1635
1-500U	 <p>2-valve rough with 1/2" NPT inlets & outlet</p>	\$477	—	—	—
1770-4273	 <p>Exposed Tub and Hand Shower Set Deck Mount Lever Handles 7.25" centers. Spout reach 9.11" Includes: 281 Hand Shower</p> 	\$2081	\$2602	\$3082	\$3122
1760-4272	 <p>Exposed Tub and Hand Shower Set Deck Mount Cross Handles 7.25" centers. Spout reach 9.11" Includes: 281 Hand Shower</p> 	\$2081	\$2602	\$3082	\$3122
1770-4283	 <p>Exposed Tub and Hand Shower Set Wall Mount Lever Handles 6" centers. Spout reach 7" Includes: 281 Hand Shower Floor-mount kit item 3-196 or 3-226 sold separately</p> 	\$2081	\$2602	\$3018	\$3122
1-378	<p>Required Rough for Exposed Tub Filler For use with 3-196 or 3-226 tub risers</p>	\$549	—	—	—

VICTORIA

			I	II	III	IV
1760-4282		Exposed Tub and Hand Shower Set Wall Mount Cross Handles 6" centers. Spout reach 7" Includes: 281 Hand Shower Floor-mount kit item 3-196 or 3-226 sold separately	\$2081	\$2602	\$3018	\$3122
						
1-378		Required Rough for Exposed Tub Filler For use with 3-196 or 3-226 tub risers	\$549	—	—	—
3-196		Floor Mount Kit for Exposed Tub Sets Set includes: 2 each Floor Flanges 2 each 3/4" Risers - 31" high Decorative Stabilizer Kit sold separately	\$767	\$980	\$1175	\$1175
3-226		Same as above only 24" high	\$736	\$944	\$1135	\$1135
3-192		3/4" Shut-off Valves for above (1 pair hot & cold)	\$1077	\$1347	\$1562	\$1616
2-734	 Wall Mount Plate	Decorative Stabilizer Kit for Exposed Tub Floor Riser Kits Adjustable for risers that are 6" to 9" apart Includes 1-1/2" finished ring for connecting kit to tub overflow pipe Finished plate for wall mounting up to 10" center of riser pipes	\$378	\$472	\$547	\$566
3-667		Tub Spout 1/2" NPT inlet fitting 9.42" spout length	\$378	\$472	\$547	\$566
4-1774BP		Balanced Pressure Tub & Shower Trim with Lever Handle Less showerhead, shower arm	\$704	\$880	\$1021	\$1056
1-684		VALVE REQUIRED Newport Brass Balanced Pressure Valve, 3 port with service stops, universal 1/2" NPT & direct sweat connections See Shower & Drain Sections to complete shower	\$365	—	—	—
4-1764BP		Balanced Pressure Tub & Shower Trim with Cross Handle Less showerhead, shower arm	\$704	\$880	\$1021	\$1056
1-684		VALVE REQUIRED Newport Brass Balanced Pressure Valve, 3 port with service stops, universal 1/2" NPT & direct sweat connections See Shower & Drain Sections to complete shower	\$365	—	—	—
5-1772BP		Balanced Pressure Tub & Shower Trim with Lever Handle Less tub spout, showerhead, shower arm	\$794	\$993	\$1152	\$1191
1-685		VALVE REQUIRED Newport Brass Balanced Pressure Valve with diverter, 4 port with service stops, universal 1/2" NPT & direct sweat connections See Shower & Drain Sections to complete shower	\$503	—	—	—

VICTORIA

		I	II	III	IV	
5-1762BP		Balanced Pressure Tub & Shower Trim with Cross Handle Less tub spout, showerhead, shower arm	\$794	\$993	\$1152	\$1191
1-685		VALVE REQUIRED Newport Brass Balanced Pressure Valve with diverter, 4 port with service stops, universal 1/2" NPT & direct sweat connections See Shower & Drain Sections to complete shower	\$503	—	—	—
3-1763TR		1/2" Thermostatic Trim Plate with Handles Integrated diverter handle with independent temperature control VALVE REQUIRED, see page 338	\$786	\$983	\$1140	\$1179
3-1764TR		3/4" Thermostatic Trim Plate with Lever Handle VALVE REQUIRED	\$831	\$1039	\$1205	\$1247
1-540		3/4" Thermostatic Rough-in Valve	\$1020	—	—	—
3-323		Diverter/Flow Control Trim Use with stop or diverter valves, see page 347-348	\$296	\$370	\$441	\$444
3-322		Diverter/Flow Control Trim Use with stop or diverter valves, see page 347-348	\$296	\$370	\$441	\$444
1600-1200		8" Towel Bar	\$230	\$288	\$334	\$345
1600-1230		18" Towel Bar	\$260	\$325	\$377	\$390
1600-1250		24" Towel Bar	\$300	\$375	\$435	\$450

VICTORIA

			I	II	III	IV
1600-1660		Double Robe Hook	\$150	\$188	\$218	\$225

1600-1500		Double Post Toilet Tissue Holder	\$300	\$375	\$435	\$450
-----------	---	----------------------------------	-------	-------	-------	-------

Coordinating Grab Bars starting on page 358

Crafted entirely from solid brass, Newport Brass tub and shower fixtures bring material integrity and quiet precision to the bath. From faucet to tub spout, showerhead to drain, every element is designed to work in harmony—offering complete finish freedom across a full suite of trims, showerheads, tub fillers, and drains for a perfectly coordinated space.

At the core of each system are Newport Brass precision valves, machined from a single piece of solid brass and individually pressure tested for uncompromising performance. Designed and crafted in-house, they deliver enduring reliability and a refined, intuitive experience—where craftsmanship is felt in every detail and built to last.

TUB &



SHOWER



TUB & SHOWER COLLECTIONS

NUMERICAL INDEX

CATEGORY	PAGE
1/2" GENERAL GUIDELINES FOR PLANNING AND LAYOUT	292
3/4" GENERAL GUIDELINES FOR PLANNING AND LAYOUT	298
3/4" THERMOSTATIC VALVE	302
FREESTANDING TUB FILLERS	304
DECORATIVE DRAINS	308
TILE IN DRAIN	311
SHOWERHEAD, ARMS & FLANGES	312
HAND SHOWERS	318
HAND SHOWER SETS	320
SLIDE BAR HAND SHOWER KITS	322
SLIDE BARS	324
SHOWER SLIDER KITS FOR GRAB BARS	326

CATEGORY	PAGE
SHOWER PARTS	328
BIDETS	330
BODY SPRAYS	332
TUB SPOUTS	334
SHOWER TRIM VALVES	338
DIVERTER / FLOW CONTROL TRIM	340
BP TUB & SHOWER TRIM SETS	350
BASKETS	354
GRAB BARS	358
SPECIALTY BATHROOM ACCESSORIES	361
TANK LEVERS	362

1/2" GENERAL GUIDELINES FOR PLANNING AND LAYOUT

1/2" thermostatic valve will provide automatic temperature control and adequate water flow to operate multiple devices. The temperature control feature is independent of the integrated transfer valve.

I-741 THERMOSTATIC VALVE

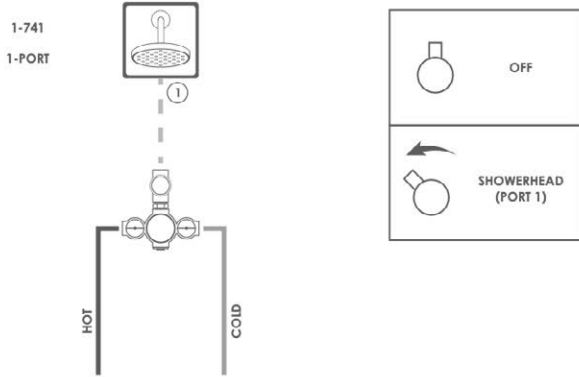
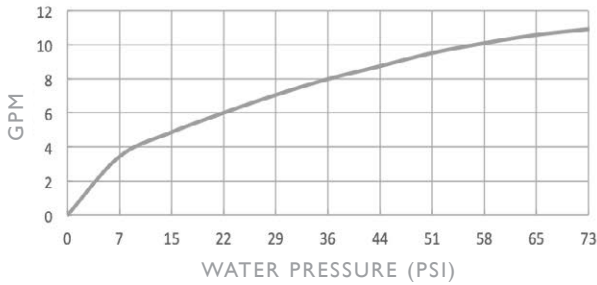

The sum total of water consumption of the combined shower outlets must not exceed the rated gallons per minute (gpm) of the thermostatic valve (see flow charts below, as measured from the top outlet, mixed hot & cold).

I-742 THERMOSTATIC VALVE

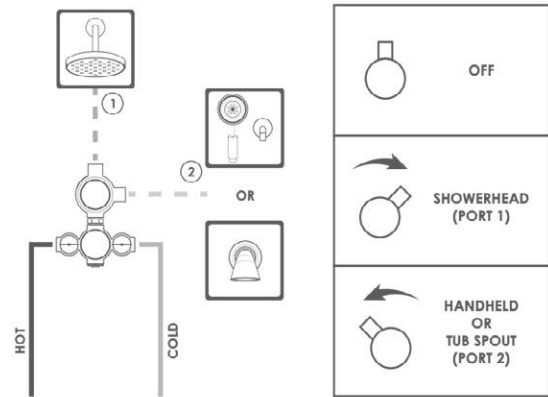
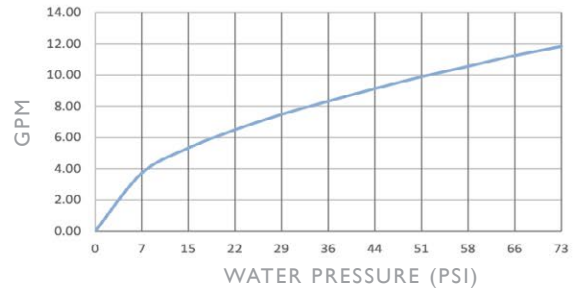

I-743 THERMOSTATIC VALVE

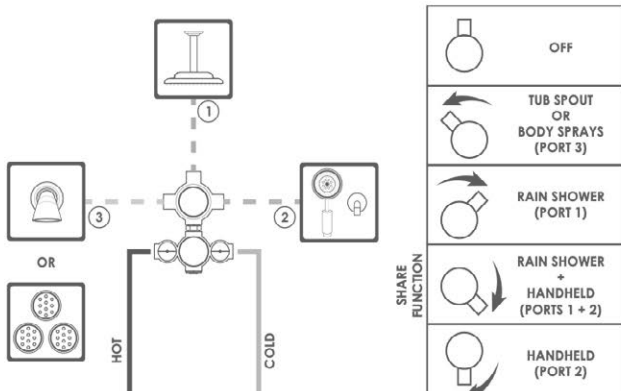
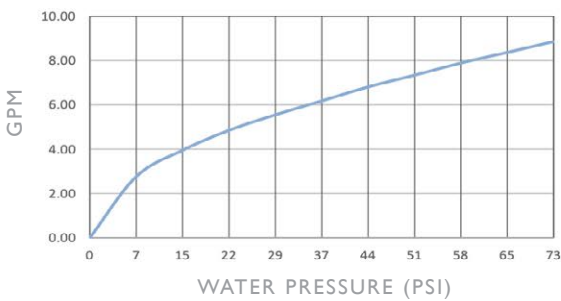

I-744 THERMOSTATIC VALVE

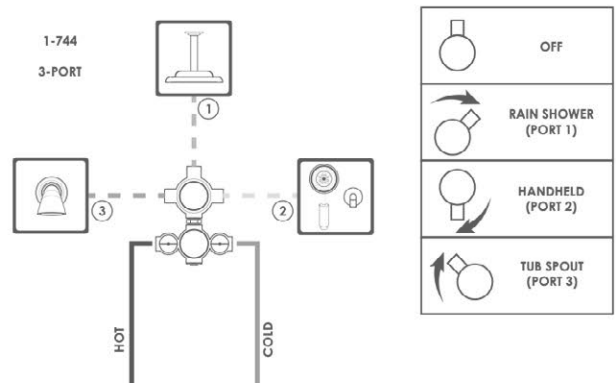
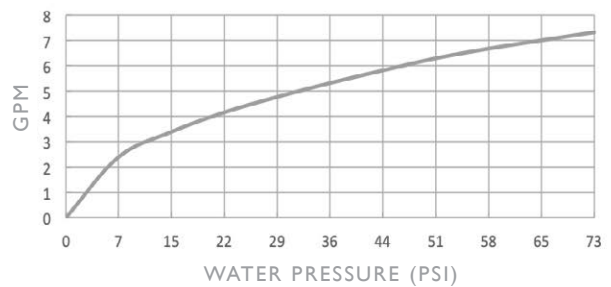

I-745 THERMOSTATIC VALVE

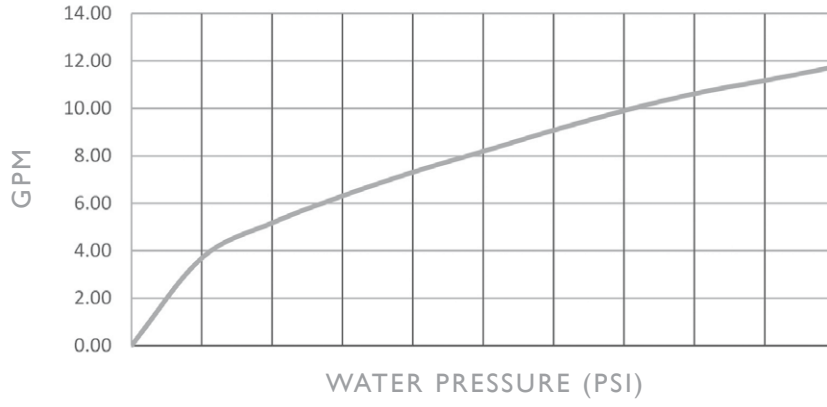

1-745
2-PORT w/ SHARE

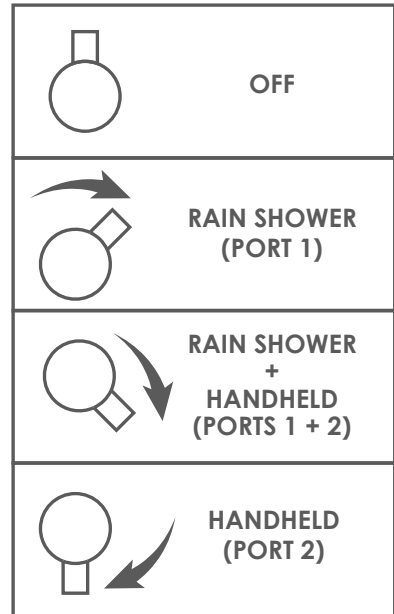
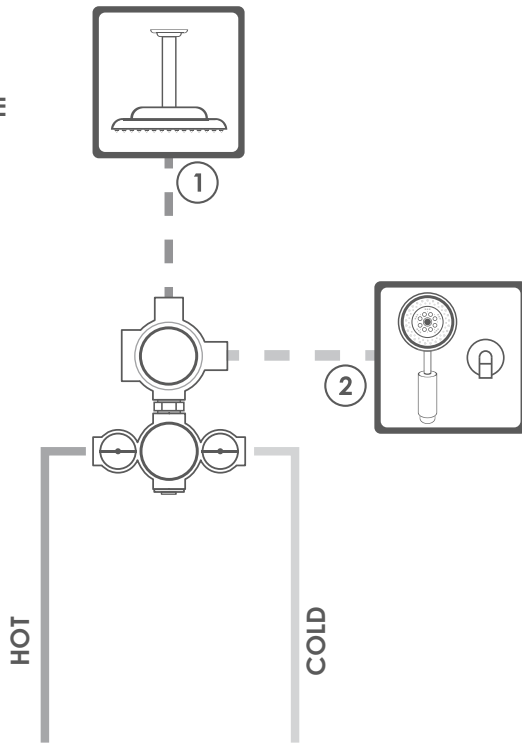

3 FUNCTION WITH OFF I-701

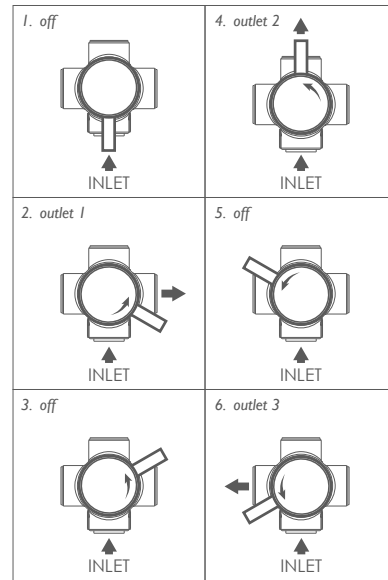
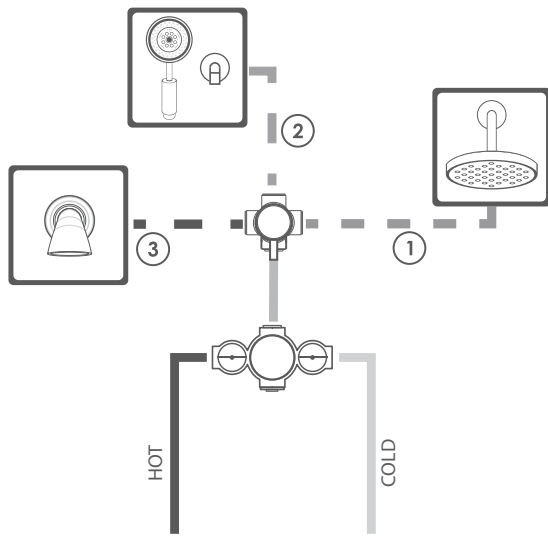

DESIGNED FOR USE WITH 3/4" THERMOSTATIC VALVE (I-540) SOLD SEPARATELY
NOT DESIGNED TO BE USED WITH BP VALVES

5 FUNCTION WITH SHARE AND OFF I-702

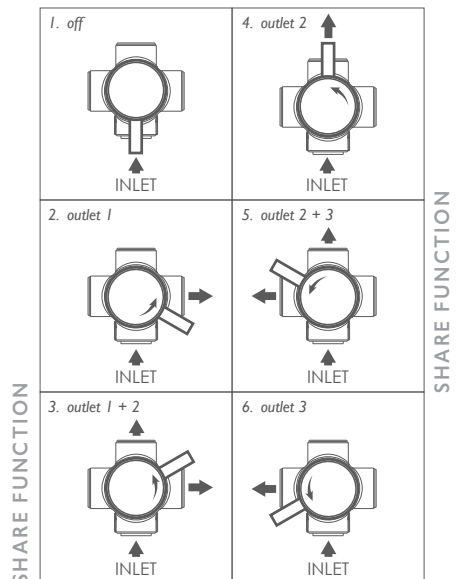
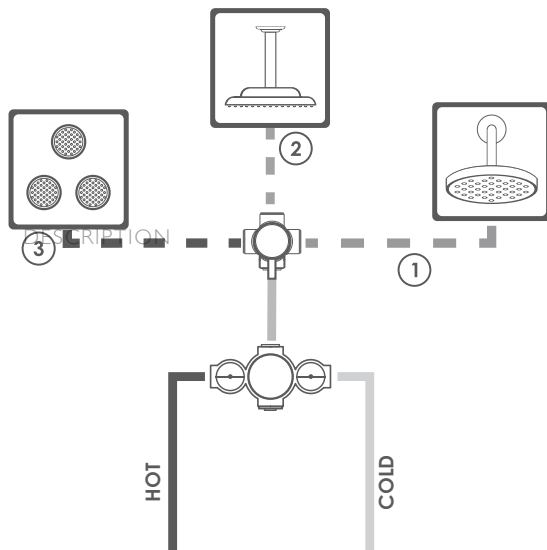

DESIGNED FOR USE WITH 3/4" THERMOSTATIC VALVE (I-540) SOLD SEPARATELY
NOT DESIGNED TO BE USED WITH BP VALVES

3 FUNCTION WITH PAUSE, FOR PRESSURE BALANCE SYSTEM I-703

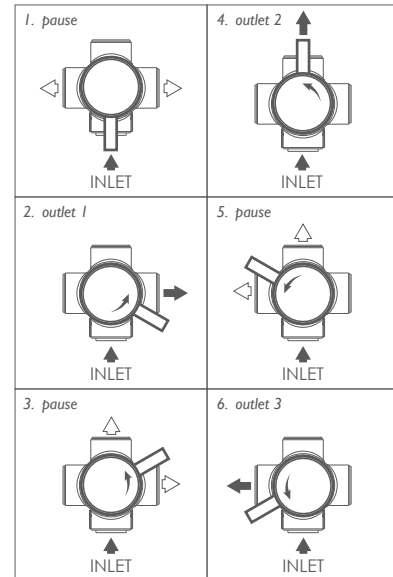
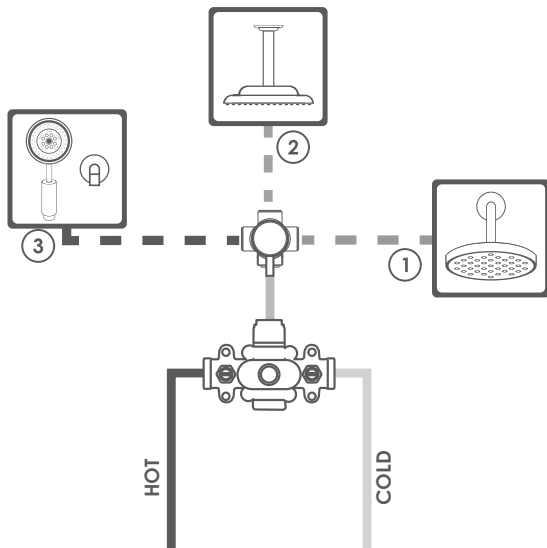

DESIGNED FOR USE WITH 3-PORT BP VALVE (I-684) SOLD SEPARATELY

2 FUNCTION WITH OFF I-704

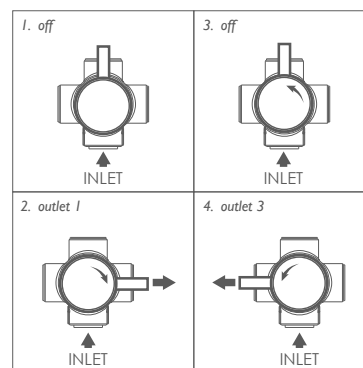
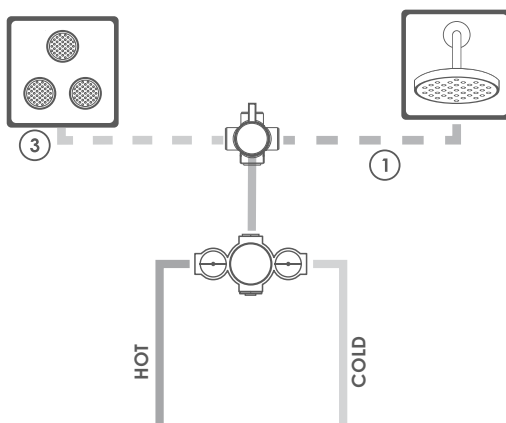

DESIGNED FOR USE WITH 3/4" THERMOSTATIC VALVE (I-540) SOLD SEPARATELY
NOT DESIGNED TO BE USED WITH BP VALVES

3 FUNCTION WITH SHARE AND OFF I-705

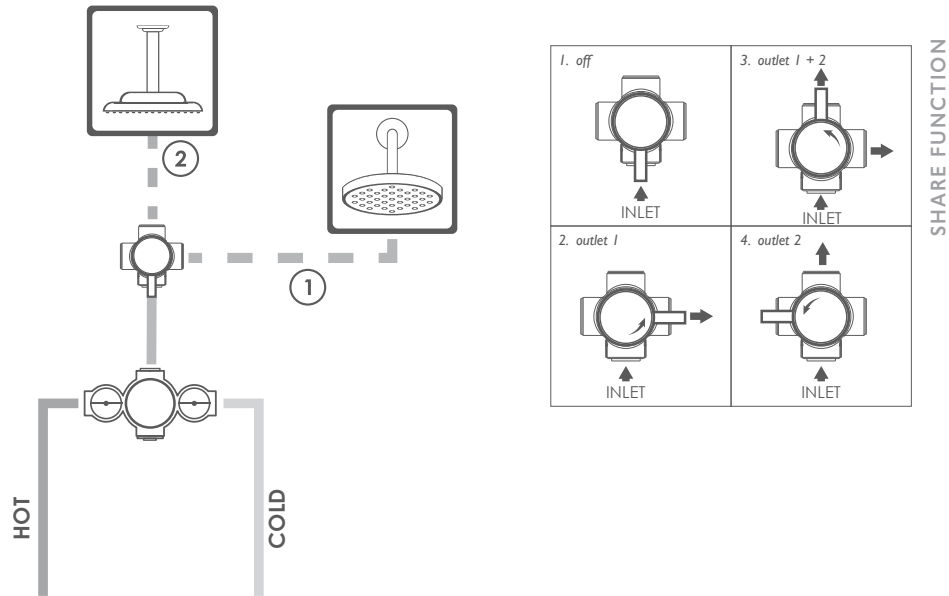

DESIGNED FOR USE WITH 3/4" THERMOSTATIC VALVE (I-540) SOLD SEPARATELY
NOT DESIGNED TO BE USED WITH BP VALVES

2 FUNCTION FOR PRESSURE BALANCE SYSTEM I-706

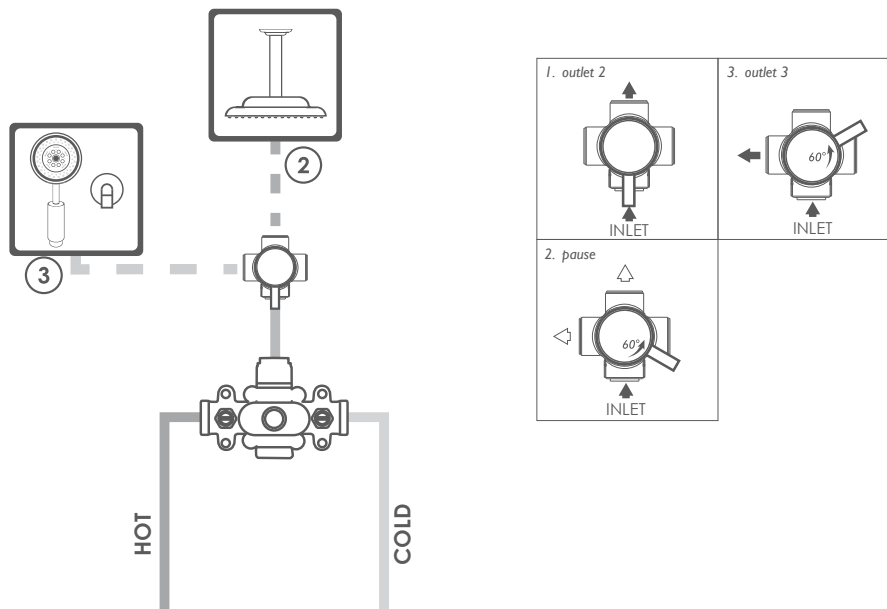

DESIGNED FOR USE WITH 3-PORT BP VALVE (I-684) SOLD SEPARATELY

3 FUNCTION SHARE (NO OFF) I-707

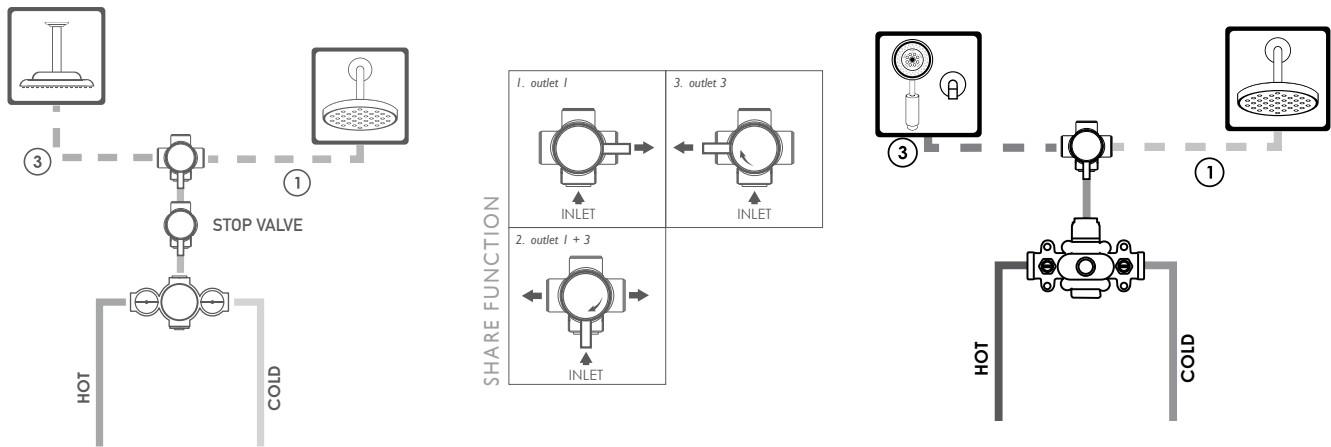

3/4" THERMOSTATIC VALVE (I-540) SETUP SHOWN ABOVE
STOP VALVE REQUIRED SOLD SEPARATELY

BALANCE PRESSURE SETUP SHOWN ABOVE
BP VALVE (I-684) SOLD SEPARATELY

1/2" DIVERTER SPARE PARTS PRICING

I-355	Spare Cartridge for I-701 - 3 function with off	\$233
I-356	Spare Cartridge for I-702 - 5 function, with share and off	\$233
I-357	Spare Cartridge for I-703 - 3 function with pause	\$233
I-358	Spare Cartridge - 6 function, no off Installation of the I-358 cartridge requires a dedicated shut-off or stop valve as part of the shower system, sold separately.	\$233
I-478	Spare Cartridge for I-704 - 2 function with off	\$233
I-479	Spare Cartridge for I-705 - 3 function with share and off	\$233
I-480	Spare Cartridge for I-706 - 2 function with pause	\$233
I-481	Spare Cartridge for I-707 - 3 function with share (no off)	\$233
I-482	Plug Nut Assembly	\$65

3/4" GENERAL GUIDELINES FOR PLANNING AND LAYOUT

- 1) **Valve**—3/4" thermostatic valve. This valve will provide automatic temperature control and adequate water flow to operate multiple devices. The temperature control feature is not only a convenience but a safety consideration as well.
- 2) **Shower Outlets**—The sum total of water consumption of the combined shower outlets must not exceed the rated gallons per minute (gpm) of the thermostatic valve (see flow chart below).
- 3) Exceeding the capacity of the valve will result in the reduction of the overall performance of the shower. Since water pressure directly facilitates optimum performance, Newport Brass recommends a minimum of 50 pounds per square inch (psi) for 3 or more outlets.

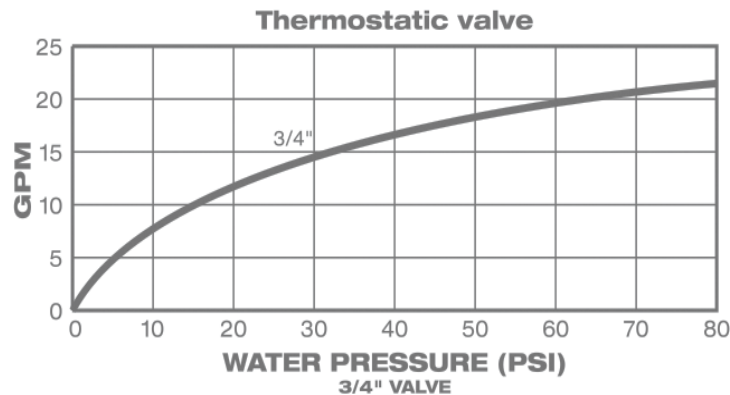

NOTE: In the case of a well/pump system, flow and pressure capacity may not accommodate a multi-component shower installation. Please consult a licensed plumber to ensure the supply you're working with is adequate.

- 4) **Removing flow restrictions** from showerheads or body sprays will upset the balance and the capacity of the valve and is a violation of national code.
- 5) When using more outlets than one thermostatic valve can accommodate, we recommend that 2 or more valves be used. If this is the case, Newport Brass suggests that the main water supply be 1" or larger.
- 6) Some plumbers 'tee' from one set of hot and cold supplies to accommodate more than one valve. This practice is not recommended. This situation requires that each valve be plumbed directly from the main water supply. It should be noted that the use of a 'tee' could cause fluctuations in temperature and water flow.

3/4" GENERAL GUIDELINES FOR PLANNING AND LAYOUT

- 7) **Volume Controls**—Most custom showers are designed with separate on/off volume controls for each outlet device. As with the other outlet devices, the volume controls also have their own flow rates. Newport Brass suggests using 3/4" volume control valves. Where cost is concerned 1/2" volume controls can be used, however, a reduction in the flow rate will result.
- 8) **Body Sprays**—It is recommended that a 1/2" pressure-balancing loop be plumbed for 2 or more body sprays. This technique will allow equal flow rates and temperature to each body spray. Please refer to diagram below.

NOTE: Pressure-Balance Loop should be used on each shower bar installed.

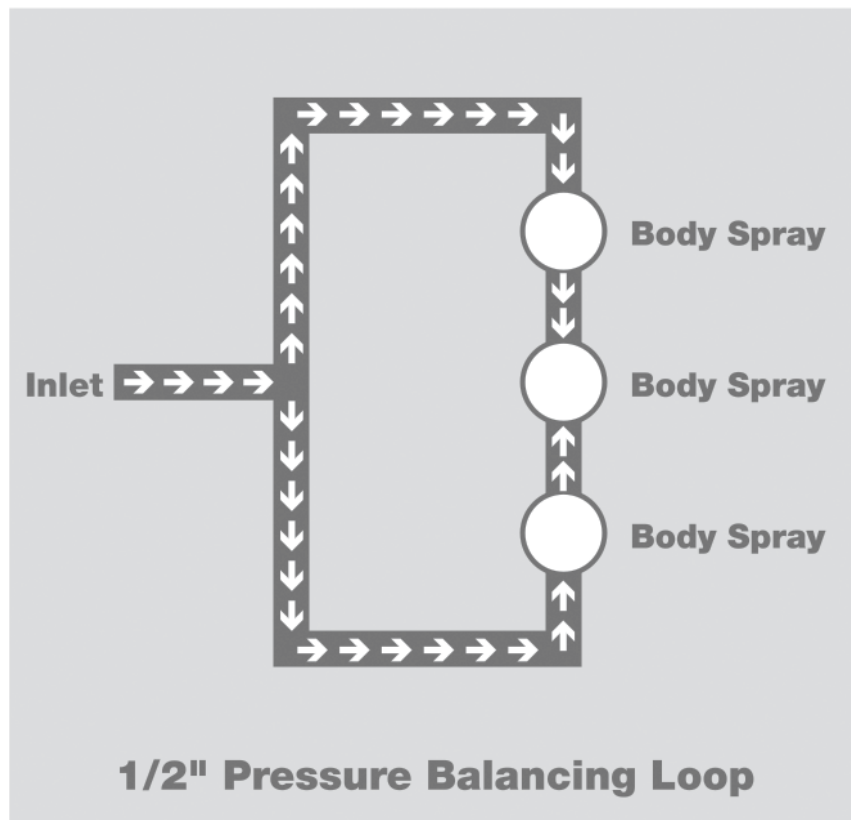

Designing the Custom Shower

Please refer to the custom shower configuration examples on the following pages for reference and client presentation purposes on your next project.

TWO-WALL POWER SYSTEM

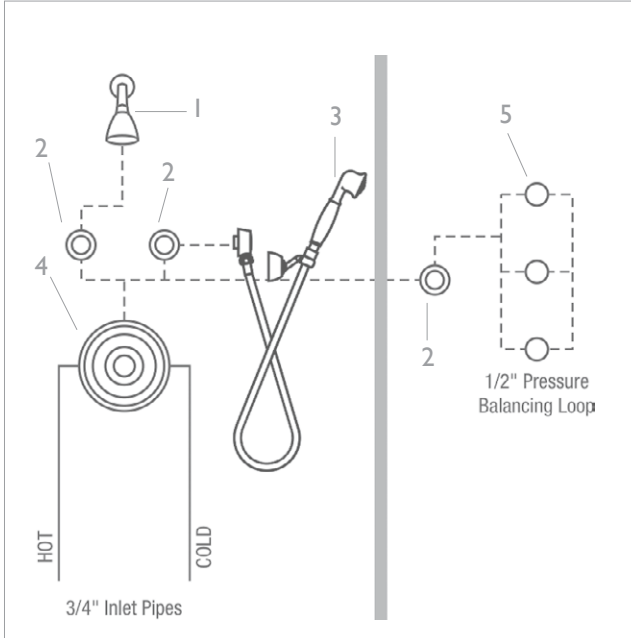

- 1) SHOWERHEAD
- 2) VOLUME CONTROL (3 ea.)
- 3) HAND SHOWER
- 4) THERMOSTATIC VALVE
- 5) BODY SPRAY (3 ea.)

TWO-WALL SYSTEM

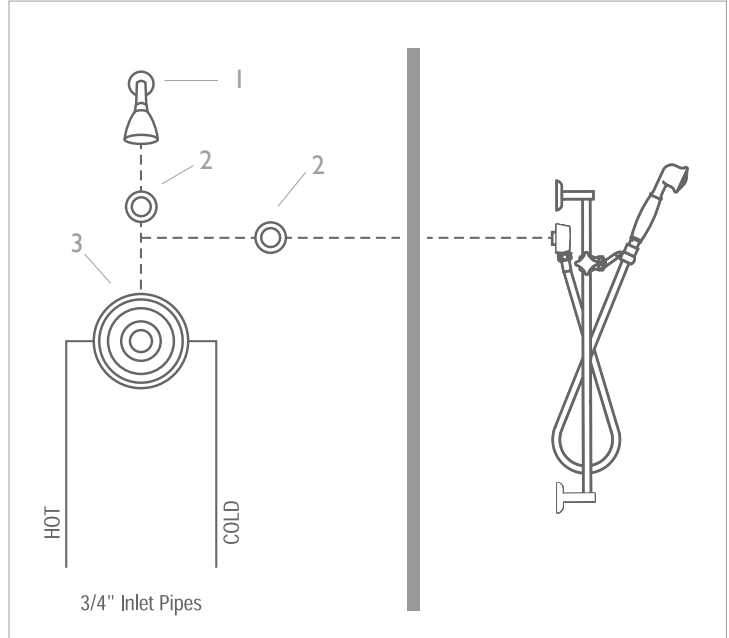

- 1) SHOWERHEAD
- 2) VOLUME CONTROL (2 ea.)
- 3) THERMOSTATIC VALVE
- 4) HAND SHOWER KIT

OPPOSITE WALLS SYSTEM

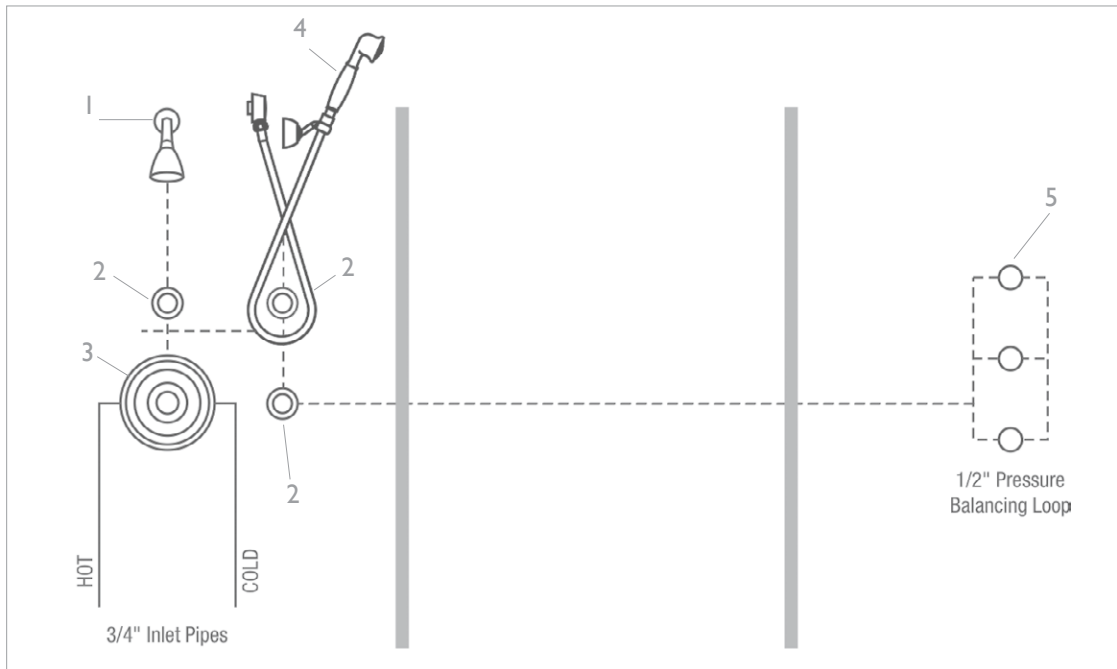

- 1) SHOWERHEAD
- 2) VOLUME CONTROL (3 ea.)
- 3) THERMOSTATIC VALVE
- 4) HAND SHOWER
- 5) BODY SPRAY (3 ea.)

THREE-WALL HIS/HERS

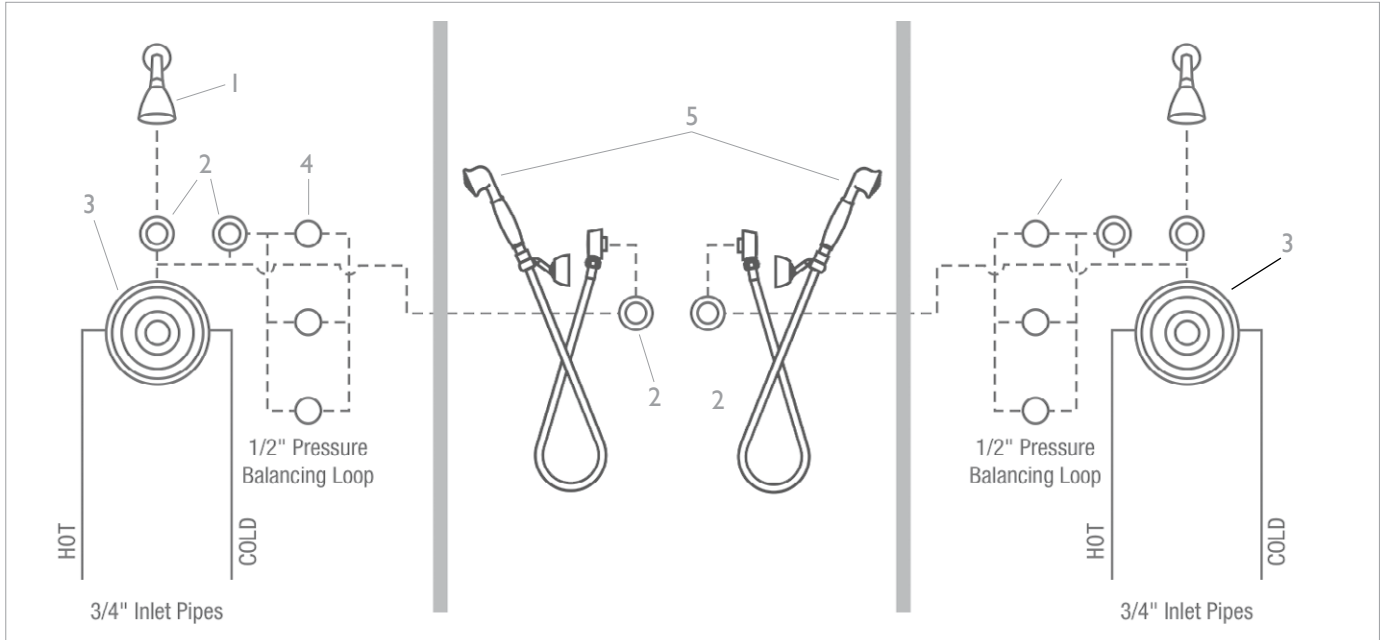

- 1) SHOWERHEAD (2 ea.)
- 2) VOLUME CONTROL (6 ea.)
- 3) THERMOSTATIC VALVE (2 ea.)
- 4) BODY SPRAY (6 ea.)
- 5) HAND SHOWER (2 ea.)

THREE-WALL & CEILING SYSTEM

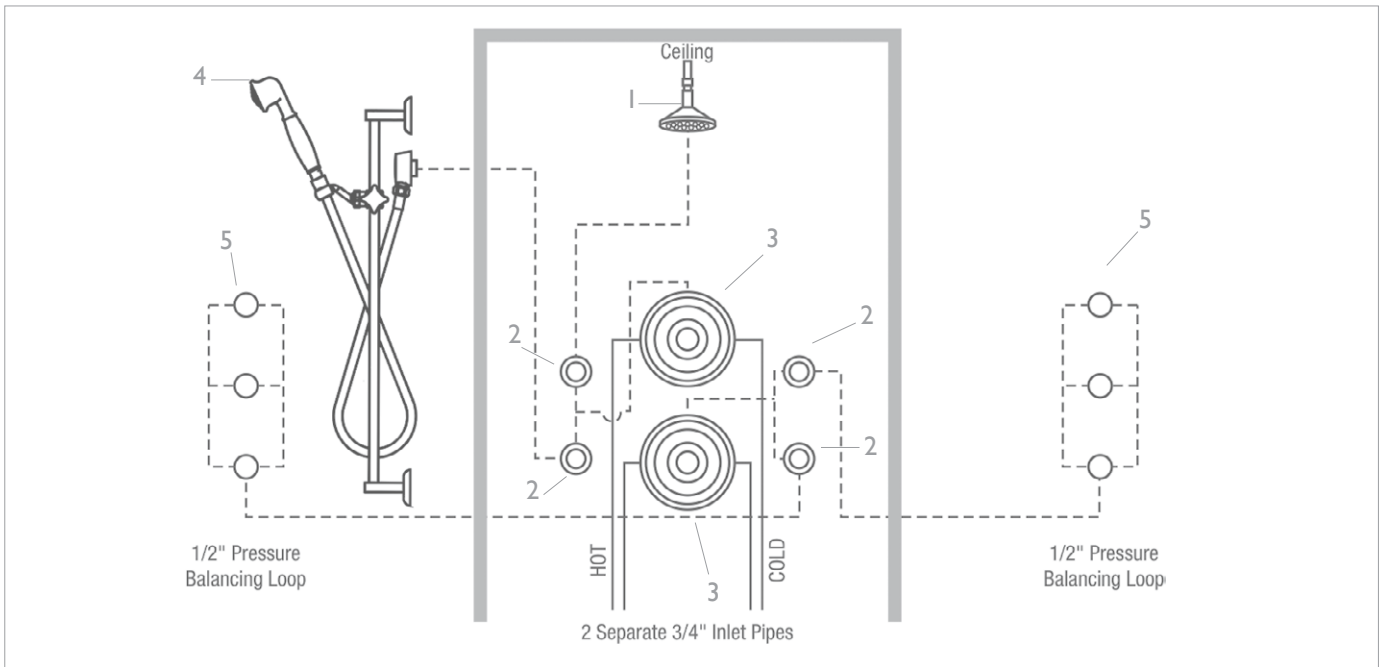

- 1) CEILING SHOWERHEAD
- 2) VOLUME CONTROL (4 ea.)
- 3) THERMOSTATIC VALVE (2 ea.)
- 4) HAND SHOWER KIT
- 5) BODY SPRAY (6 ea.)

3/4" THERMOSTATIC VALVE

Newport Brass is pleased to provide you with the following Component Price List and Shower System Planner for your convenience.

These pages will provide you with all of the tools needed to create a versatile and unique showering environment.

Custom shower installations can be confusing, but they don't have to be as long as you keep a few simple things in mind.



Please refer to "General Guidelines for Planning and Layout" and create your new shower system by following these easy steps:

- 1) Select "In-Wall Plumbing Products" for rough valve pricing.
- 2) Select design Collection-finish with Round or Square Trim Plate.
- 3) Select shower system components.



Please refer to Shower System Planner.

Quantity	Part	Description
Example: Two-Wall Power System— Matches Astor Collection in Satin Nickel Finish		
1	3-924TR-15S	Round Trim Plate/Handle for 3/4" Thermo Valve
1	211-15S	Showerhead
3	3-163-15S	Trim Kit for Volume Control (Stop Valves)
1	288-15S	Supply Outlet with Holder for Handshower
1	284-15S	Handshower Hose, 59"
1	281-15S	Handshower with Smooth Handle
3	2170-15S	Body Spray
1	1-540	3/4" Thermostatic Rough-In Valve
3	1-607U	3/4" Volume Control (Stop Valves) Roughs

FREESTANDING TUB FILLERS

		I	II	III	IV
910-4261	 <p>Free Standing Tub Filler 37.22" (94.5cm) spout height at outlet (from floor) 8.73" (22.2cm) spout reach (c-c) 43.3" overall height Single handle flow/temperature control Includes 3/4" braided steel supply line connectors Includes 3/4" to 1/2" supply line adapter Meets AMSE A1 12.18.1/CSA B125.1 requirements 12 gallons (45.2 liters) per minute maximum flow rate (spout) 1.8 gallons (6.8 liters) per minute maximum flow rate (hand shower)</p> <p>Matches Astor Collection</p> 	\$2862	\$3578	\$4150	\$4293



930-4261	 <p>Free Standing Tub Filler 35.95" (91.3cm) spout height at outlet (from floor) 8.72" (22.2cm) spout reach (c-c) 41.93" overall height Single handle flow/temperature control Includes 3/4" braided steel supply line connectors Includes 3/4" to 1/2" supply line adapter Meets AMSE A1 12.18.1/CSA B125.1 requirements 9.25 gallons (35 liters) per minute maximum flow rate (spout) 1.8 gallons (6.8 liters) per minute maximum flow rate (hand shower)</p> <p>Matches Chesterfield Collection</p> 	\$2862	\$3578	\$4150	\$4293
----------	--	--------	--------	--------	--------



		I	II	III	IV
1400-4261	 <p>15, 15S & 26 FINISH</p> <p>ALL OTHER FINISHES</p> 	\$2862	\$3578	\$4150	\$4293
<p>Free Standing Tub Filler 36.53" (92.7cm) spout height at outlet (from floor) 10.05" (25.5cm) spout reach (c-c) 40.37" overall height Single handle flow/temperature control Includes 3/4" braided steel supply line connectors Includes 3/4" to 1/2" supply line adapter Meets AMSE A112.18.1/CSA B125.1 requirements 9.25 gallons (35 liters) per minute maximum flow rate (spout) 1.8 gallons (6.8 liters) per minute maximum flow rate (hand shower)</p> <p>Matches East Linear Collection</p> <p>NOTE: 15, 15S, 26 finishes include handshower item 3-459 All other finishes include handshower item #283-101 Switching the handshower is not an option on finishes 15, 15S, and 26</p>					

2040-4261	 <p>15, 15S & 26 FINISH</p> <p>ALL OTHER FINISHES</p> 	\$2862	\$3578	\$4150	\$4293
<p>Free Standing Tub Filler 37.99" (96.5cm) spout height at outlet (from floor) 8.66" (22.0cm) spout reach (c-c) 43" overall height Single handle flow/temperature control Includes 3/4" braided steel supply line connectors Includes 3/4" to 1/2" supply line adapter Meets AMSE A112.18.1/CSA B125.1 requirements</p> <p>Matches Secant Collection</p> <p>NOTE: 15, 15S, 26 finishes include handshower item 3-453 All other finishes include handshower item #283-102 Switching the handshower is not an option on finishes 15, 15S, and 26</p>					



TUB & SHOWER



FREESTANDING TUB FILLERS

		I	II	III	IV	
2480-4261	 <p>15, 15S & 26 FINISH</p> <p>ALL OTHER FINISHES</p>	<p>Free Standing Tub Filler 38.03" (96.6cm) spout height at outlet (from floor) 8.66" (22.0cm) spout reach (c-c) 43" overall height Single handle flow/temperature control Includes 3/4" braided steel supply line connectors Includes 3/4" to 1/2" supply line adapter Meets AMSE A112.18.1/CSA B125.1 requirements 9.25 gallons (35 liters) per minute maximum flow rate (spout) 1.8 gallons (6.8 liters) per minute maximum flow rate (hand shower)</p> <p>Matches East Linear and Pavani Collection</p> <p>NOTE: 15, 15S, 26 finishes include handshower item 3-459 All other finishes include handshower item #283-101 Switching the handshower is not an option on finishes 15, 15S, and 26</p> 	\$2862	\$3578	\$4150	\$4293

2560-4261	 <p>15, 15S & 26 FINISH</p> <p>ALL OTHER FINISHES</p>	<p>Free Standing Tub Filler 38.02" (96.6cm) spout height at outlet (from floor) 7.86" (19.9cm) spout reach (c-c) 39.49" overall height Single handle flow/temperature control Includes 3/4" braided steel supply line connectors Includes 3/4" to 1/2" supply line adapter Meets AMSE A112.18.1/CSA B125.1 requirements 9.25 gallons (35 liters) per minute maximum flow rate (spout) 1.8 gallons (6.8 liters) per minute maximum flow rate (hand shower)</p> <p>Matches Secant Collection</p> <p>NOTE: 15, 15S, 26 finishes include handshower item 3-459 All other finishes include handshower item #283-101 Switching the handshower is not an option on finishes 15, 15S, and 26</p> 	\$2862	\$3578	\$4150	\$4293
-----------	---	---	--------	--------	--------	--------

FREESTANDING TUB FILLERS

	I	II	III	IV
2940-4261	\$2862	\$3578	\$4150	\$4293
 <p>Free Standing Tub Filler 37.22" (94.5cm) spout height at outlet (from floor) 8.73" (22.2cm) spout reach (c-c) 43.31" overall height Single handle flow/temperature control Includes 3/4" braided steel supply line connectors Includes 3/4" to 1/2" supply line adapter Meets AMSE A112.18.1/CSA B125.1 requirements 12 gallons (45.2 liters) per minute maximum flow rate (spout) 1.8 gallons (6.8 liters) per minute maximum flow rate (hand shower)</p> <p>Matches Taft Collection</p> 				

3290-4261	\$2862	\$3578	\$4150	\$4293
 <p>Free Standing Tub Filler 37.26" (94.7cm) spout height at outlet (from floor) 8.73" (22.2cm) spout reach (c-c) 43" overall height Single handle flow/temperature control Includes 3/4" braided steel supply line connectors Includes 3/4" to 1/2" supply line adapter Meets AMSE A112.18.1/CSA B125.1 requirements 9.25 gallons (35 liters) per minute maximum flow rate (spout) 1.8 gallons (6.8 liters) per minute maximum flow rate (hand shower)</p> <p>Matches Muncy Collection</p> 				





I-339	\$434	—	—	—
 <p>Optional Rough for Freestanding Tub Filler For subfloor and concrete floor installations 4.53" overall height 7.20" overall base diameter Universal 3/4" NPT and 1/2" direct sweat connections Test caps included</p>				

DECORATIVE DRAINS

HOW TO ORDER

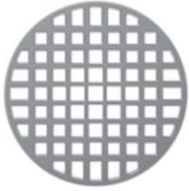
- STEP 1:** Select Shower Drain
STEP 2: Select Required Drain Throat #277-03
STEP 3: Select Drain Body (If Required)

STEP 01

4" SHOWER DRAIN	243-401 4" Shower Drain 	243-403 4" Shower Drain 	243-404 4" Shower Drain 	243-406 4" Shower Drain 
Pricing	I \$336 II \$420 III \$487 IV \$504	I \$336 II \$420 III \$487 IV \$504	I \$336 II \$420 III \$487 IV \$504	I \$336 II \$420 III \$487 IV \$504

STEP 02

REQUIRED ACCESSORY	277-03 4" Round Shower Drain Throat 2" IPS Outlets 
Pricing	\$144

STEP 03









OPTIONAL ACCESSORIES	278-01 Drain Body, Cast Iron 2" Inlet, IPS 2" Outlet 	278A-01 NO HOT MOP Drain Body, ABS 2" Inlet, IPS 2" Solvent Weld Outlet 	278P-01 NO HOT MOP Drain Body, PVC 2" Inlet, IPS 2" Solvent Weld Outlet 	277-01A 2" Adapter Kit Cast Iron 	277-01-E Drain Throat Extension for 2" Inlet 
Pricing	\$127	\$104	\$104	\$86	\$144

OPTIONAL ACCESSORIES	RPI-288 2" No Hub Coupling 
Pricing	\$50

DECORATIVE DRAINS

HOW TO ORDER

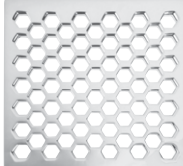
- STEP I:** Select Shower Drain
STEP I: Select Required Drain Throat #277-01
STEP I: Select Drain Body (If Required)

STEP 01						
4" SHOWER DRAIN	233-401 4" Shower Drain 	233-402 4" Shower Drain 	233-403 4" Shower Drain 	233-403 4" Shower Drain 	233-405 4" Shower Drain 	
Pricing	I \$336 II \$420 III \$487 IV \$504	I \$336 II \$420 III \$487 IV \$504	I \$336 II \$420 III \$487 IV \$504	I \$336 II \$420 III \$487 IV \$504	I \$336 II \$420 III \$487 IV \$504	I \$336 II \$420 III \$487 IV \$504
4" SHOWER DRAIN	233-406 4" Shower Drain 	233-407 4" Shower Drain 	233-408 4" Shower Drain 			
Pricing	I \$336 II \$420 III \$487 IV \$504	I \$336 II \$420 III \$487 IV \$504	I \$336 II \$420 III \$487 IV \$504			

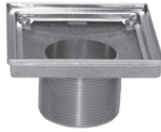
STEP 02	
REQUIRED ACCESSORY	277-01 4" Square Shower Drain Throat 2" IPS Outlet 
Pricing	\$137

STEP 02						
OPTIONAL ACCESSORIES	278-01 Drain Body, Cast Iron 2" Inlet, IPS 2" Outlet 	278A-01 NO HOT MOP Drain Body, ABS 2" Inlet, IPS 2" Solvent Weld Outlet 	278P-01 NO HOT MOP Drain Body, PVC 2" Inlet, IPS 2" Solvent Weld Outlet 	277-01A 2" Adapter Kit Cast Iron 	277-01-E Drain Throat Extension for 2" Inlet 	RPI-288 2" No-Hub Coupling 
Pricing	\$127	\$104	\$104	\$86	\$144	\$50







TUB & SHOWER

DECORATIVE DRAINS

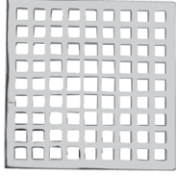
HOW TO ORDER

- STEP 1:** Select Shower Drain
STEP 2: Select Required Drain Throat #277-03
STEP 3: Select Drain Body (If Required)

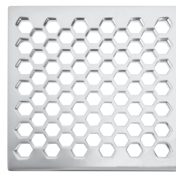
STEP 01

6" SQUARE DRAINS	233-601 6" Shower Drain 	233-603 6" Shower Drain 	233-604 6" Shower Drain 	233-606 6" Shower Drain 	233-607 6" Shower Drain 
Pricing	I \$383 II \$479 III \$555 IV \$574	I \$383 II \$479 III \$555 IV \$574	I \$383 II \$479 III \$555 IV \$574	I \$383 II \$479 III \$555 IV \$574	I \$383 II \$479 III \$555 IV \$574
REQUIRED ACCESSORY	277-02 6" Square Shower Drain Throat 4" IPS Outlet 				
Pricing	\$207				

STEP 03

OPTIONAL ACCESSORIES	278-02 Drain Body, Cast Iron 4" Inlet, IPS 2" Outlet 	278A-02 NO HOT MOP Drain Body, ABS 4" Inlet, IPS 2" Solvent Weld Outlet 	278P-02 NO HOT MOP Drain Body, PVC 2" Inlet, IPS 2" Solvent Weld Outlet 	277-02A 2" Adapter Kit Cast Iron 	277-02-E Drain Throat Extension for 2" Inlet 
Pricing	\$165	\$138	\$138	\$103	\$144
OPTIONAL ACCESSORIES	RPI-288 2" No Hub Coupling 				
Pricing	\$50				

TILE IN DRAIN





HOW TO ORDER

STEP 1: Customer Selects Desired Tile (not included)

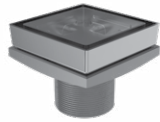
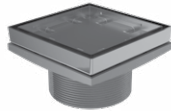
STEP 2: Select Required Drain Rough #277-04 or #277-06

STEP 3: Select Drain Body (If Required)

STEP 02			
REQUIRED ACCESSORY	277-04 4" Tile in Drain Throat 	277-06 6" Tile in Drain Throat 	
Pricing	I \$495 II \$619 III \$718 IV \$743	I \$556 II \$757 III \$807 IV \$834	

STEP 03 FOR 277-04 (4" DRAIN THROAT)						
OPTIONAL ACCESSORIES	278-01 Drain Body, Cast Iron 2" Inlet, IPS 2" Outlet 	278A-01 NO HOT MOP Drain Body, ABS 2" Inlet, IPS 2" Solvent Weld Outlet 	278P-01 NO HOT MOP Drain Body, PVC 2" Inlet, IPS 2" Solvent Weld Outlet 	277-01A 2" Adapter Kit Cast Iron 	277-01-E Drain Throat Extension for 2" Inlet 	RPI-288 2" No-Hub Coupling 
Pricing	\$127	\$104	\$104	\$86	\$144	\$50

STEP 03 FOR 277-06 (6" DRAIN THROAT)						
OPTIONAL ACCESSORIES	278-02 Drain Body, Cast Iron 4" Inlet, IPS 2" Outlet 	278A-02 NO HOT MOP Drain Body, ABS 4" Inlet, IPS 2" Solvent Weld Outlet 	278P-02 NO HOT MOP Drain Body, PVC 2" Inlet, IPS 2" Solvent Weld Outlet 	277-02A 2" Adapter Kit Cast Iron 	277-01-E Drain Throat Extension for 4" Inlet 	RPI-288 2" No-Hub Coupling 
Pricing	\$165	\$138	\$138	\$103	\$144	\$50

TUB & SHOWER

SHOWERHEAD, ARMS & FLANGES

CUSTOMIZE YOUR SHOWER

STEP 1: Select Showerhead All are 1.8 Gallons (6.8 liters) per minute maximum flow rate











STEP 2: Select Shower Arm

STEP 3: Select Shower Flange

OR

STEP 4: Select Nipple & Escutcheon Kit

STEP 01

SHOWERHEAD 1/2" NPT	<p>211</p> <p>3.5" Diameter 8 Shower Jets</p> 	<p>212</p> <p>2.75" Diameter 6 Shower Jets</p> 	<p>214</p> <p>5.5" Diameter, Single Function, 29 Spray Jets</p> 	<p>2141</p> <p>6" Diameter Single Function</p> 	<p>2142</p> <p>6" Diameter Single Function</p> 
Pricing	<p>I \$523 II \$653 III \$758 IV \$784</p>	<p>I \$385 II \$481 III \$558 IV \$578</p>	<p>I \$1039 II \$1299 III \$1507 IV \$1559</p>	<p>I \$604 II \$755 III \$885 IV \$906</p>	<p>I \$604 II \$755 III \$885 IV \$906</p>
SHOWERHEAD 1/2" NPT	<p>2143</p> <p>6" Diameter, Multifunction, 3 Spray Modes</p> 	<p>2144</p> <p>6" Diameter, Multifunction, 3 Spray Modes</p> 	<p>2154</p> <p>8" x 3" Single Function</p> 	<p>2155</p> <p>4" Diameter, Multifunction, 3 Spray Patterns</p> 	<p>2156</p> <p>4.25" Diameter 3 Spray Patterns</p> 
Pricing	<p>I \$677 II \$847 III \$1002 IV \$1016</p>	<p>I \$677 II \$847 III \$1002 IV \$1016</p>	<p>I \$746 II \$932 III \$1082 IV \$1119</p>	<p>I \$310 II \$387 III \$449 IV \$465</p>	<p>I \$310 II \$387 III \$449 IV \$465</p>
SHOWERHEAD 1/2" NPT	<p>2157</p> <p>8.5" Diameter, Multifunction, 3 Spray Modes</p> 	<p>2158</p> <p>8.5" Diameter, Multifunction, 3 Spray Modes</p> 	<p>2159</p> <p>8" Square, Multifunction, 3 Spray Modes</p> 		
Pricing	<p>I \$777 II \$971 III \$1126 IV \$1165</p>	<p>I \$777 II \$971 III \$1126 IV \$1165</p>	<p>I \$777 II \$971 III \$1126 IV \$1165</p>		

SHOWERHEAD, ARMS & FLANGES

CUSTOMIZE YOUR SHOWER

STEP 1: Select Showerhead All are 1.8 Gallons
(6.8 liters) per minute maximum flow rate













STEP 2: Select Shower Arm

STEP 3: Select Shower Flange

OR

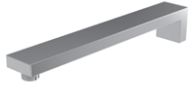
STEP 4: Select Nipple & Escutcheon Kit

STEP 02

SHOWER ARM 1/2" NPT	200 6" Shower Arm 	201 7.5" Shower Arm 	201-1 8" Shower Arm with Flange 	201-2 9" Shower Arm 	200-2001 18" Shower Arm 
Pricing	I \$78 II \$98 III \$117 IV \$117	I \$85 II \$107 III \$125 IV \$128	I \$341 II \$426 III \$494 IV \$511	I \$375 II \$469 III \$544 IV \$563	I \$395 II \$494 III \$573 IV \$592
SHOWER ARM 1/2" NPT	202 90° 12" Shower Arm 	2021 90° 18" Shower Arm 	202-1 90° 12" Shower Arm 2.5" Height 	201-1001 12" Shower Arm 	203 9" Shower Arm 
Pricing	I \$183 II \$229 III \$266 IV \$275	I \$190 II \$238 III \$276 IV \$285	I \$359 II \$449 III \$520 IV \$538	I \$526 II \$657 III \$762 IV \$789	I \$105 II \$131 III \$152 IV \$157
SHOWER ARM 1/2" NPT	200-1001 12" Shower Arm 	205 "S" Shower Arm Raises Showerhead 10" 	208 7.5" Shower Arm 		
Pricing	I \$149 II \$186 III \$215 IV \$223	I \$144 II \$180 III \$209 IV \$216	I \$273 II \$341 III \$396 IV \$409		

SHOWERHEAD, ARMS & FLANGES

CUSTOMIZE YOUR SHOWER

STEP 1: Select Showerhead All are 1.8 Gallons
(6.8 liters) per minute maximum flow rate









STEP 2: Select Shower Arm

STEP 3: Select Shower Flange

OR

STEP 4: Select Nipple & Escutcheon Kit

STEP 03











1/2" SHOWER FLANGE	<p>206</p> <p>2-3/8" Outer Diameter</p> 	<p>206-1</p> <p>2-1/4" Outer Diameter</p> 	<p>207</p> <p>2-3/8" Outer Diameter</p> 	<p>2-332</p> <p>2-3/8" Outer Diameter</p> 
Pricing	<p>I \$56 II \$70</p> <p>III \$81 IV \$84</p>	<p>I \$56 II \$70</p> <p>III \$81 IV \$84</p>	<p>I \$56 II \$70</p> <p>III \$81 IV \$84</p>	<p>I \$150 II \$187</p> <p>III \$217 IV \$224</p>
1/2" SHOWER FLANGE	<p>2-503</p> <p>2-3/8" Outer Diameter</p> 	<p>2-640</p> <p>2-1/2" Square</p> 		
Pricing	<p>I \$56 II \$70</p> <p>III \$81 IV \$84</p>	<p>I \$150 II \$187</p> <p>III \$217 IV \$224</p>		
3/4" SHOWER FLANGE	<p>2-221</p> <p>2-3/8" Outer Diameter</p> 	<p>206-301</p> <p>2.5" Outer Diameter</p> 	<p>206-302</p> <p>2-1/4" Outer Diameter</p> 	
Pricing	<p>I \$150 II \$187</p> <p>III \$217 IV \$224</p>	<p>I \$150 II \$187</p> <p>III \$217 IV \$224</p>	<p>I \$150 II \$187</p> <p>III \$217 IV \$224</p>	

SHOWERHEAD, ARMS & FLANGES

CUSTOMIZE YOUR SHOWER

- STEP 1:** Select Showerhead All are 1.8 Gallons (6.8 liters) per minute maximum flow rate
STEP 2: Select Shower Arm
STEP 3: Select Shower Flange
 OR
STEP 4: Select Nipple & Escutcheon Kit

STEP 01

1/2" NPT Overhead Showerheads	215 9" Diameter Single Function  	2152 9" Diameter Single Function  	2153 9" Diameter Single Function  	2161 7.9" Diameter Single Function  
	Pricing I \$2541 II \$3177 III \$3685 IV \$3812	Pricing I \$1190 II \$1487 III \$1770 IV \$1784	Pricing I \$1190 II \$1487 III \$1770 IV \$1784	Pricing I \$853 II \$1066 III \$1236 IV \$1279
3/4" NPT Overhead Showerheads	2162 11.5" Diameter Single Function  	2165 11.5" Diameter Single Function  NEW	2168 11.5" Diameter Single Function  NEW	
	Pricing I \$1099 II \$1374 III \$1609 IV \$1649	Pricing I \$1299 II \$1624 III \$1884 IV \$1949	Pricing I \$1299 II \$1624 III \$1884 IV \$1949	

STEP 02

1/2" NPT SHOWER ARM	202 90° 12" Shower Arm 5" Height 	2021 90° 18" Shower Arm 5" Height 
	Pricing I \$183 II \$229 III \$266 IV \$275	Pricing I \$190 II \$238 III \$276 IV \$285

TUB & SHOWER

SHOWERHEAD, ARMS & FLANGES

CUSTOMIZE YOUR SHOWER

STEP 1: Select Showerhead All are 1.8 Gallons
(6.8 liters) per minute maximum flow rate

STEP 2: Select Shower Arm

STEP 3: Select Shower Flange

OR

STEP 4: Select Nipple & Escutcheon Kit

STEP 02



1/2" NPT Nipple	200-7102 2" 200-7104 4" 200-7106 6" 200-7108 8" 200-7110 10"	200-7112 12" 200-7118 18"	200-7124 24" 200-7130 30"
	Nipple	Nipple	Nipple
Pricing	I \$104 II \$134	I \$149 II \$186	I \$197 II \$246
	III \$151 IV \$156	III \$215 IV \$223	III \$285 IV \$295



1/2" NPT Nipple & Escutcheon	517-2 2" 517-4 4" 517-6 6" 517-8 8" 517-10 10"	517-12 12" 517-18 18"	517-24 24" 517-30 30"	517-36 36" 517-42 42"
	Nipple & Escutcheon	Nipple & Escutcheon	Nipple & Escutcheon	Nipple & Escutcheon
Pricing	I \$155 II \$194	I \$212 II \$265	I \$256 II \$319	I \$314 II \$393
	III \$226 IV \$233	III \$308 IV \$318	III \$376 IV \$383	III \$469 IV \$471















1/2" NPT Nipple & Escutcheon	516-2 2" 516-4 4" 516-6 6" 516-8 8" 516-10 10"	516-12 12" 516-18 18"	516-24 24" 516-30 30"	516-36 36" 516-42 42"
	Nipple & Escutcheon	Nipple & Escutcheon	Nipple & Escutcheon	Nipple & Escutcheon
Pricing	I \$171 II \$213	I \$241 II \$302	I \$297 II \$371	I \$374 II \$468
	III \$252 IV \$256	III \$356 IV \$362	III \$446 IV \$446	III \$553 IV \$561











New Thin Shower Head in Polished Nickel (15P) (see page 315)

HAND SHOWERS

		I	II	III	IV
280	 <p>Single Function Hand Shower Grooved Brass Handle</p> 	\$260	\$325	\$377	\$390
281	 <p>Single Function Hand Shower Smooth Brass Handle Solid Brass, without Hose</p> 	\$259	\$323	\$375	\$388
281-I	 <p>Traditional Multifunctional Hand Shower 3-spray patterns: Spray, Rain & Massage</p> <p>Does not work with bracket on item No. 287, 288 and 292.</p> 	\$580	\$725	\$841	\$870
283	 <p>Single Function Hand Shower</p> 	\$363	\$495	\$612	\$612
283-101	 <p>Single Function Hand Shower Round, Contemporary</p> 	\$363	\$495	\$612	\$612
283-102	 <p>Single Function Hand Shower Square, Contemporary</p> 	\$363	\$495	\$612	\$612

HAND SHOWERS







		I	II	III	IV	
283-2	 	Single Function Hand Shower	\$363	\$495	\$612	\$612
283-201	 	Single Function Hand Shower	\$363	\$495	\$612	\$612
283-3	 	Contemporary Multifunctional Hand Shower 3-spray patterns: Spray, Rain & Massage Hose not included Does not work with bracket on item No. 287, 288 and 292	\$580	\$725	\$841	\$870
283-4	 	Contemporary Single Function Hand Shower Does not work with bracket on item # 287, 288 and 292	\$567	\$709	\$822	\$851

TUB & SHOWER

HAND SHOWER SETS

		I	II	III	IV	
280A		<p>Wall-Mounted Hand Shower Kit Diverts from in-wall supply using diverter valve Consists of No. 280 Hand Shower, No. 284 Hose, No. 285 Supply Elbow, and No. 287 Wall Bracket</p> 	\$710	\$887	\$1029	\$1065
281A		<p>Wall-Mounted Hand Shower Kit Diverts from in-wall supply using diverter valve Consists of No. 281 Hand Shower, No. 284 Hose, No. 285 Supply Elbow, and No. 287 Wall Bracket</p> 	\$682	\$852	\$1013	\$1022
280G		<p>Traditional Hand Shower Set Includes: No. 281-1 Traditional Multifunction Hand Shower No. 284 Braided Hose No. 285-1 Supply Elbow No. 297 Coordinating Wall Bracket</p> 	\$1031	\$1288	\$1494	\$1546
280H		<p>Contemporary Hand Shower Set Includes: No. 283-3 Contemporary Multifunction Hand Shower No. 284 Braided Hose No. 285-2 Supply Elbow No. 296 Coordinating Wall Bracket</p> 	\$1031	\$1288	\$1494	\$1546
280J		<p>Contemporary Hand Shower Set Includes: No. 283-4 Contemporary Single Function Hand Shower No. 284 Braided Hose No. 285-5 Supply Elbow No. 296-1 Coordinating Square Wall Bracket</p> 	\$1031	\$1288	\$1494	\$1546
280M		<p>Contemporary Hand Shower Set Includes: No. 283-4 Contemporary Single Function Hand Shower No. 284 Braided Hose No. 285-6 Supply Elbow No. 296-1 Coordinating Square Wall Bracket</p> 	\$1031	\$1288	\$1494	\$1546

HAND SHOWER SETS

			I	II	III	IV
28ON		<p>Traditional Hand Shower Set</p> <p>Includes:</p> <ul style="list-style-type: none"> No. 281-1 Traditional Multifunction Hand Shower No. 284 Braided Hose No. 285-3 Supply Elbow No. 297 Wall Coordinating Round Bracket 	\$1031	\$1288	\$1494	\$1546
						
28OP		<p>Contemporary Hand Shower Set</p> <p>Includes:</p> <ul style="list-style-type: none"> No. 283-102 Single Function Hand Shower No. 284 Braided Hose No. 3-671 Supply Elbow & Holder Combo 	\$708	\$885	\$1026	\$1062
						
28OR		<p>Contemporary Hand Shower Set</p> <p>Includes:</p> <ul style="list-style-type: none"> No. 283-101 Single Function Hand Shower No. 284 Braided Hose No. 3-672 Supply Elbow & Holder Combo 	\$708	\$885	\$1026	\$1062
						

TUB & SHOWER

SLIDE BAR HANDSHOWER KITS



		I	II	III	IV	
280D		Slide Bar Handshower Kit Water supply from in-wall supply using diverter valve Includes: No. 280 Handshower No. 284 Hose No. 285 Supply Elbow No. 292 Slide Bar with Adjustable Bracket	\$1177	\$1472	\$1707	\$1766
						
281D		Slide Bar Handshower Kit Water supply from in-wall supply using diverter valve Includes: No. 281 Handshower No. 284 Hose No. 285 Supply Elbow No. 292 Slide Bar with Adjustable Bracket	\$1075	\$1344	\$1559	\$1613
						
280E		Traditional 36" Slide Bar Handshower Kit All Brass Includes: No. 281-1 Traditional Multifunction Hand Shower No. 284 Braided Hose No. 285-1 Supply Elbow No. 294 36" Slide Bar with Adjustable Bracket	\$1580	\$1975	\$2348	\$2370
						
280F		Contemporary 36" Slide Bar Handshower Kit All Brass Includes: No. 283-3 Contemporary Multifunctional Hand Shower No. 284 Braided Hose No. 285-2 Supply Elbow No. 295 36" Slide Bar with Adjustable Bracket	\$1580	\$1975	\$2348	\$2370
						
280L		Traditional 36" Slide Bar Handshower Kit All Brass Includes: No. 281-1 Traditional Multifunctional Hand Shower No. 284 Braided Hose No. 285-3 Supply Elbow No. 294-1 36" Slide Bar with Adjustable Bracket	\$1580	\$1975	\$2348	\$2370
						

SLIDE BAR HANDSHOWER KITS

			I	II	III	IV
280s		<p>Contemporary 36" Slide Bar Handshower Kit All Brass</p> <p>Includes: No. 283-101 Single Function Handshower No. 284 Braided Hose No. 285-2 Supply Elbow No. 295 36" Slide Bar with Adjustable Bracket</p>	\$1262	\$1577	\$1917	\$1917
						

280T		<p>Contemporary 36" Slide Bar Handshower Kit</p> <p>Includes: No. 283-102 Single Function Handshower No. 284 Braided Hose No. 285-7 Supply Elbow No. 295-1 Slide Bar with Adjustable Bracket</p>	\$1262	\$1577	\$1917	\$1917
						









SLIDE BARS

		I	II	III	IV
292	 <p>Wall-Mounted Slide Bar with Adjustable Bracket for holding Hand Shower 23" c-c. 3" projection. 2 concealed screws</p> <p>Does not work with 281-1, 283-3 and 283-4 handshowers</p>	\$630	\$788	\$914	\$945
294	 <p>Traditional 36" Wall-Mounted Slide bar with Adjustable Bracket</p>	\$853	\$1066	\$1236	\$1279
294-I	 <p>Traditional 36" Wall-Mounted Slide bar with Adjustable Bracket</p>	\$853	\$1066	\$1236	\$1279
295	 <p>Contemporary 36" Wall-Mounted Slide bar with Adjustable Bracket</p>	\$853	\$1066	\$1236	\$1279



SLIDE BARS



		I	II	III	IV	
295-I		Contemporary 36" Wall-Mounted Slide bar with Adjustable Bracket.	\$875	\$1093	\$1268	\$1312

SHOWER SLIDER KITS FOR GRAB BARS







		I	II	III	IV
930-0442	 <p>Shower Slider Kit For Grab Bar Traditional, Cross handle Includes: No. 284 hose No. 285-1 supply elbow No. 281-1 handshower No. 20-411 slider No. 20-408 handle</p> <p>GRAB BAR SOLD SEPARATELY</p> 	\$1228	\$1535	\$1793	\$1842
930-0443	 <p>Shower Slider Kit For Grab Bar Traditional, Lever handle Includes: No. 284 hose No. 285-1 supply elbow No. 281-1 handshower No. 20-411 slider No. 2-136 handle</p> <p>GRAB BAR SOLD SEPARATELY</p> 	\$1228	\$1535	\$1793	\$1842
990-0442	 <p>Shower Slider Kit For Grab Bar Contemporary, Cross handle Includes: No. 284 hose No. 285-2 supply elbow No. 283-3 handshower No. 20-410 slider No. RP20-289 handle</p> <p>GRAB BAR SOLD SEPARATELY</p> 	\$1228	\$1535	\$1793	\$1842
990-0443	 <p>Shower Slider Kit For Grab Bar Contemporary, Lever handle Includes: No. 284 hose No. 285-2 supply elbow No. 283-3 handshower No. 20-410 slider No. RP2-111H handle</p> <p>GRAB BAR SOLD SEPARATELY</p> 	\$1228	\$1535	\$1793	\$1842

SHOWER SLIDER KITS FOR GRAB BARS

		I	II	III	IV
2040-0442	 <p>Shower Slider Kit For Grab Bar Contemporary, Cross handle Includes: No. 284 hose No. 285-7 supply elbow No. 283-102 handshower No. 20-410 slider No. RP20-406 handle</p> <p>GRAB BAR SOLD SEPARATELY</p> 	\$1228	\$1535	\$1793	\$1842

2040-0443	 <p>Shower Slider Kit For Grab Bar Contemporary, Lever handle Includes: No. 284 hose No. 285-7 supply elbow No. 283-102 handshower No. 20-410 slider No. RP20-407 handle</p> <p>GRAB BAR SOLD SEPARATELY</p> 	\$1228	\$1535	\$1793	\$1842
-----------	---	--------	--------	--------	--------





SHOWER PARTS

			I	II	III	IV
284		59" Hand Shower Hose Double spiral for strength Solid Brass	\$217	\$272	\$315	\$326
285		Supply Elbow for Hand Shower Hose Solid Brass	\$116	\$145	\$168	\$174
285-1		Traditional Supply Elbow Solid Brass	\$145	\$182	\$211	\$218
285-2		Contemporary Supply Elbow Solid Brass	\$145	\$182	\$211	\$218
285-3		Traditional Supply Elbow	\$145	\$182	\$211	\$218
285-5		Contemporary Supply Elbow	\$145	\$182	\$211	\$218
285-6		Contemporary Supply Elbow	\$145	\$182	\$211	\$218



SHOWER PARTS

			I	II	III	IV
3-671		Contemporary Supply Elbow & Holder - Square	\$322	\$444	\$529	\$529
3-672		Contemporary Supply Elbow & Holder - Round	\$322	\$444	\$529	\$529
287		Wall Bracket for Hand Shower Does not work with 281-1, 283-3 and 283-4 handshowers	\$176	\$220	\$255	\$264
288		Supply Outlet with holder for Hand Shower Does not work with 281-1, 283-3 and 283-4 handshowers.	\$221	\$276	\$320	\$331
296		Contemporary Wall Mount Bracket Matches 283-3 Hand Shower Not adjustable Solid Brass	\$192	\$240	\$279	\$288
296-1		Contemporary Wall Mount Bracket Matches 283-4 Hand Shower Not adjustable Solid Brass	\$192	\$240	\$279	\$288
297		Traditional Wall-Mount Bracket Matches 281-1 Hand Shower Not adjustable Solid Brass	\$192	\$240	\$279	\$288
291		Vacuum Breaker for Hand Showers. In-line type For wall-hung showers only. Not for deck-mounted Hand Showers IAPMO-UPC listed Solid Brass	\$104	\$131	\$158	\$165

BIDETS

		I	II	III	IV	
929		Bidet Set 1/2" valves. Includes Bottom Spray, with vacuum breaker, 4 hole mount bidet	\$1907	\$2446	\$2936	\$3025
989		Bidet Set 1/2" valves. Includes Bottom Spray with vacuum breaker, 4 hole mount bidet	\$2040	\$2620	\$3147	\$3240
999L		Bidet Set 1/2" valves. Includes bottom spray with vacuum breaker, 4 hole mount bidet	\$1925	\$2477	\$2973	\$2973
2049		Bidet Set 1/2" valves. Includes bottom spray with vacuum breaker, 4 hole mount bidet	\$1798	\$2247	\$2607	\$2697
2419		Bidet Set. Lever Handles 1/2" valves. Includes bottom spray with vacuum breaker, 4 hole mount bidet	\$1798	\$2247	\$2607	\$2697
2489		Bidet Set, Lever Handles 1/2" valves. Includes bottom spray with vacuum breaker, 4 hole mount bidet	\$1725	\$2156	\$2501	\$2587

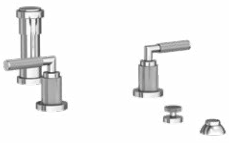
BIDETS

			I	II	III	IV
3429		<p>Bidet Set Lever Handles. 1/2" valves Includes bottom spray with vacuum breaker, 4 hole mount bidet</p>	\$2066	\$2583	\$2996	\$3202
3439		<p>Bidet Set Lever Handles. 1/2" valves Includes bottom spray with vacuum breaker, 4 hole mount bidet</p>	\$2066	\$2583	\$2996	\$3202

BODY SPRAYS

		I	II	III	IV
217	 <p>Solid Brass. 1-7/8" diameter. 1-3/4" projection 1/2" female IPS pivot connection With flange. 1.75 GPM Max Solid Brass</p>	\$218	\$273	\$317	\$327
2170	 <p>Body Spray 1/2" female inlet. 1.75 GPM Max Solid Brass</p>	\$314	\$393	\$456	\$471
2171	 <p>Body Spray with volume control 1-7/8" diameter. 2-5/16" projection 1/2" female IPS pivot connection With flange. 1.75 GPM Max Solid Brass</p>	\$314	\$393	\$456	\$471
2173	 <p>Body Spray Square Escutcheon 1/2" female inlet. 1.75 GPM Max Solid Brass</p>	\$314	\$393	\$456	\$471
2174	 <p>Body Spray Round Escutcheon 1/2" female inlet. 1.75 GPM Max Solid Brass</p>	\$314	\$393	\$456	\$471
2178	 <p>Body Spray 1/2" female inlet. 1.75 GPM Max Solid Brass</p>	\$314	\$393	\$456	\$471

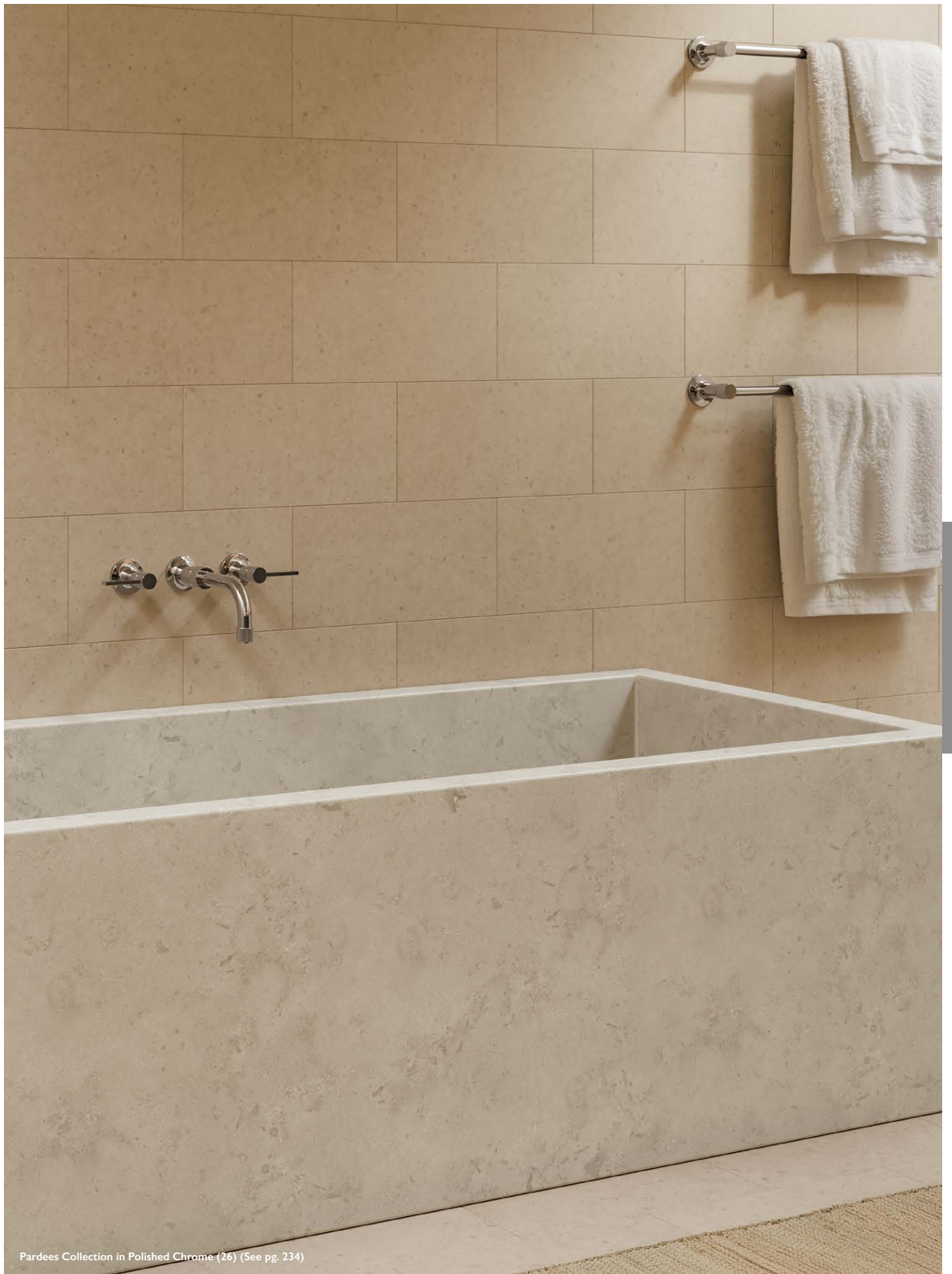







TUB SPOUTS

			I	II	III	IV
2201		Tub Spout 1/2" NPT inlet fitting 6.71" spout overall length Matches Seaport Collection	\$262	\$333	\$395	\$400
20-258		Tub Spout 3/4" NPT inlet fitting 7.35" spout overall length Matches Joffrey Collection	\$381	\$488	\$581	\$581
2-144		Tub Spout 1/2" NPT inlet fitting 7.56" spout overall length Matches Astor, Chesterfield, and Metropole Collections	\$277	\$347	\$402	\$416
2-250		Tub Spout 1/2" NPT inlet fitting 6.29" spout overall length Matches Amisa Collection	\$289	\$362	\$419	\$434
2-564		Tub Spout with Stream Straightener 3/4" NPT inlet (1/2" bushing included) 7.43" spout overall length Matches Seaport and Miro Collections	\$312	\$390	\$453	\$468
3-234		Tub Spout 1/2" NPT inlet fitting 7" spout overall length Matches Dorrance and East Linear Collections	\$274	\$342	\$397	\$411
3-328		Tub Spout 1/2" NPT inlet fitting 6.94" spout overall length Matches Secant Collection	\$296	\$370	\$429	\$444

TUB SPOUTS





			I	II	III	IV
3-383		Tub Spout 1/2" NPT inlet fitting 7.82" spout overall length Matches Aylesbury Collection	\$296	\$370	\$429	\$444
3-407		Tub Spout 1/2" NPT inlet fitting 9.15" spout overall length Matches Pavani Collection	\$296	\$370	\$429	\$444
3-419		Tub Spout 1/2" NPT inlet fitting 9.15" spout overall length Matches Pavani Collection	\$296	\$370	\$429	\$444
3-427		Tub Spout 3/4" NPT inlet fitting 6.90" spout overall length Matches Ithaca Collection	\$366	\$457	\$530	\$548
3-583		Tub Spout 1/2" NPT inlet fitting 7.92" spout overall length Matches Malvina Collection	\$411	\$514	\$596	\$617
3-614		Tub Spout 1/2" NPT inlet fitting 11.15" spout overall length Matches Pavani Collection	\$366	\$457	\$530	\$548
3-615		Tub Spout 1/2" NPT inlet fitting 11.15" spout overall length Matches Pavani Collection	\$366	\$457	\$530	\$548

TUB SPOUTS

			I	II	III	IV
3-641		Tub Spout with Stream Straightener 1/2" NPT inlet fitting 8.75" spout overall length Matches Pardees Collection	\$436	\$545	\$633	\$654
3-642		Tub Spout 1/2" NPT inlet fitting 8.82" spout overall length Matches Clemens Collection	\$436	\$545	\$633	\$654
3-643		Tub Spout 1/2" NPT inlet fitting 8.79" spout overall length Matches Griffey Collection	\$436	\$545	\$633	\$654
3-667		Tub Spout 1/2" NPT inlet fitting 9.42" spout overall length Matches Victoria Collection	\$378	\$472	\$547	\$566
3-668		Tub Spout 1/2" NPT inlet fitting 10.32" spout overall length Matches Jacobean Collection	\$296	\$370	\$429	\$444
3-669		Tub Spout 1/2" NPT inlet fitting 9.83" spout overall length Matches Aylesbury Collection	\$296	\$370	\$429	\$444
3-677		Tub Spout 1/2" NPT inlet fitting 7.06" spout overall length Matches Kimbell Collection	\$484	\$605	\$702	\$751

NEW

TUB SPOUTS

			I	II	III	IV
3-695		Tub Spout with Stream Straightener 1/2" NPT inlet fitting 9.94" spout overall length Matches Muncy Collection	\$351	\$439	\$509	\$527
3-724		Tub Spout 1/2" NPT inlet fitting 9.50" spout overall length Matches Tolmin Collection	\$361	\$451	\$524	\$542
3-729		Tub Spout 1/2" NPT inlet fitting 9.94" spout overall length Matches Taft Collection	\$361	\$451	\$524	\$542
8-030		Tub Spout 3/4" NPT inlet fitting 9.44" spout overall length Matches Secant Collection	\$474	\$592	\$686	\$710
20-131		Tub Spout 1/2" NPT inlet fitting 6.71" spout overall length Matches Vander Collection	\$289	\$369	\$421	\$434

SHOWER TRIM VALVES

PICK A VALVE AND THEN
CHOOSE TRIM PLATES

BP SHOWER VALVE

I-684 Newport Brass BP Valve, 3 port with service stops, universal 1/2" NPT & direct sweat connections \$365 — — —



BP TUB & SHOWER VALVE

I-685 Newport Brass BP Valve with diverter, 4 port with service stops, universal 1/2" NPT & direct sweat \$503 — — —



1/2" THERMOSTATIC VALVES

I-741 1/2" Thermostatic Rough-in with Volume/Shut off Control. Flow rate of 10.25 gpm at 60 PSI hot & cold mixed flow. Factory calibrated comfort setting at 100° F, built-in check valves w/service stops Independent adjustment of temperature & volume control. \$686 — — —



I-742 1/2" Thermostatic Rough-in** w/Integrated 2 Way Diverter & Shut off Control Flow rate of 10 gpm at 60 PSI hot and cold mixed flow, top outlet. Factory calibrated comfort setting at 100° F, built-in check valves w/service stops Independent adjustment of temperature & volume control. \$821 — — —



I-743 1/2" Thermostatic Rough-in w/Integrated 3 Way Diverter w/share function ports 1 & 2, & Shut Off Control. Flow rate of 8 gpm at 60 PSI hot & cold mixed flow, combo outlet. Factory calibrated comfort setting at 100° F, built-in check valves w/service stops Independent adjustment of temperature & volume control. \$898 — — —



I-744 1/2" Thermostatic Rough-in** w/Integrated 3 Way Diverter & Shut off Control Flow rate of 6.75 gpm at 60 PSI hot and cold mixed flow, top outlet. Factory calibrated comfort setting at 100° F, built-in check valves w/service stops Independent adjustment of temperature & volume control. \$898 — — —



I-745 1/2" Thermostatic Rough-in w/Integrated 2 Way Diverter w/share function ports 1 & 2, & shut off control. Flow rate of 8 gpm at 60 PSI hot and cold mixed flow, top outlet. Factory calibrated comfort setting at 100° F, built-in check valves w/service stops Independent adjustment of temperature & volume control \$821 — — —



**Cal Green Compliant

SHOWER TRIM VALVES

3/4" THERMOSTATIC VALVES		I	II	III	IV
I-540	 <p>3/4" Thermostatic Rough-in Valve Flow rate of 18 gpm at 60 PSI. Factory calibrated comfort setting at 100° F, built-in check valves w/service stops</p> <p>MUST USE WITH SEPARATE STOP/VOLUME CONTROL</p>	\$1020	—	—	—
TUB FILLER ROUGHS		I	II	III	IV
I-378	 <p>Required Rough For Exposed Tub Filler For subfloor or concrete floor installations 3.65" overall height 10.38" x 5" overall base size Universal 1/2" NPT connections. Test caps included For use with 3-196 or 3-226 tub risers</p>	\$549	—	—	—
I-469	 <p>Required Rough for Exposed Tub Filler with Risers For subfloor or concrete floor installations 3.65" overall height 10.38" x 5" overall base size Universal 1/2" NPT connections. Test caps included For use with 1500-426X tub fillers with risers</p>	\$705	—	—	—
I-339	 <p>Optional Rough for Freestanding Tub Filler For subfloor and concrete floor installations 4.53" overall height 7.20" overall base diameter Universal 3/4" NPT and 1/2" direct sweat connections Test caps included</p>	\$434	—	—	—





DIVERTER / FLOW CONTROL TRIM

			I	II	III	IV
3-163		Diverter/Flow Control Trim.Arrow Insert	\$302	\$378	\$438	\$453
3-163B		Diverter/Flow Control Trim.Plain Insert Use with stop or diverter valves Matches Astor and Chesterfield Collections	\$276	\$345	\$401	\$414
3-188H		Diverter/Flow Control Trim.Hot. Use with stop or diverter valves Matches Amisa Collection	\$405	\$520	\$624	\$624
3-202		Diverter/Flow Control Trim Use with stop or diverter valves Matches Seaport Collection	\$260	\$335	\$400	\$400
3-227		Diverter/Flow Control Trim Use with stop or diverter valves Matches East Linear Collection	\$288	\$371	\$445	\$445
3-227LH		Diverter/Flow Control Trim.Hot. Use with stop or diverter valves Matches East Linear Collection	\$288	\$371	\$445	\$445
3-230		Diverter/Flow Control Trim.Arrow.	\$253	\$324	\$390	\$390
3-230B		Diverter/Flow Control Trim.Plain Insert Use with stop or diverter valves NOTE: HOT & COLD HANDLE BUTTONS ARE IN FRENCH Matches Chesterfield Collection	\$253	\$324	\$390	\$390
3-241		Diverter/Flow Control Handle Trim.Arrow Insert	\$253	\$324	\$390	\$390
3-241B		Diverter/Flow Control Trim.Plain Insert Use with stop or diverter valves Matches Chesterfield Collection	\$253	\$324	\$390	\$390

DIVERTER / FLOW CONTROL TRIM

			I	II	III	IV
3-245		Diverter/Flow Control Trim Use with stop or diverter valves Matches Metropole Collection	\$253	\$324	\$390	\$390
3-248		Diverter/Flow Control Trim Use with stop or diverter valves Matches Alexandria Collection	\$427	\$545	\$654	\$654
3-255		Diverter/Flow Control Trim Use with stop or diverter valves Matches East Linear Collection	\$288	\$371	\$445	\$465
3-279		Diverter/Flow Control Trim Use with stop or diverter valves Matches Miro Collection	\$309	\$394	\$473	\$473
3-279L		Diverter/Flow Control Trim Use with stop or diverter valves Matches Miro Collection	\$309	\$394	\$473	\$473
3-289		Diverter/Flow Control Trim Use with stop or diverter valves Matches Seaport Collection	\$475	\$593	\$704	\$712
3-322		Diverter/Flow Control Trim Use with stop or diverter valves Matches Victoria Collection	\$296	\$370	\$441	\$444

DIVERTER / FLOW CONTROL TRIM

			I	II	III	IV
3-323		Diverter/Flow Control Trim Use with stop or diverter valves Matches Victoria Collection	\$296	\$370	\$441	\$444
3-343		Diverter/Flow Control Trim Use with stop or diverter valves Matches Astor Collection	\$253	\$324	\$390	\$390
3-368		Diverter/Flow Control Trim Use with stop or diverter valves Matches Secant Collection	\$286	\$357	\$415	\$429
3-373		Diverter/Flow Control Trim Use with stop or diverter valves Matches Aylesbury and Jacobean Collections	\$286	\$357	\$415	\$429
3-374		Diverter/Flow Control Trim Use with stop or diverter valves Matches Aylesbury and Jacobean Collections	\$286	\$357	\$415	\$429
3-378		Diverter/Flow Control Trim Use with stop or diverter valves Matches Aylesbury Collection	\$286	\$357	\$415	\$429
3-379		Diverter/Flow Control Trim Use with stop or diverter valves Matches Aylesbury Collection	\$286	\$357	\$415	\$429



DIVERTER / FLOW CONTROL TRIM

			I	II	III	IV
3-447		Diverter/Flow Control Handle Crystal Handle Use with stop or diverter valves Matches Metropole Collection	\$464	\$580	\$672	\$695
3-549		Diverter/Flow Control Trim Use with stop or diverter valves Matches Pavani Collection	\$287	\$359	\$416	\$431
3-561		Diverter/Flow Control Trim, Lever Handle Use with stop or diverter valves Matches Vander Collection	\$318	\$397	\$460	\$476
3-570		Diverter/Flow Control Trim Use with stop or diverter valves Matches East Linear Collection	\$355	\$443	\$514	\$532
3-573		Diverter/Flow Control Trim Use with stop or diverter valves Matches Dorrance Collection	\$275	\$344	\$399	\$413
3-575		Diverter/Flow Control Trim Use with stop or diverter valves Matches Dorrance Collection	\$275	\$344	\$399	\$413
3-577		Diverter/Flow Control Trim Use with stop or diverter valves Matches Secant Collection	\$286	\$357	\$415	\$429

DIVERTER / FLOW CONTROL TRIM

			I	II	III	IV
3-580		Diverter/Flow Control Trim, Cold Use with stop or diverter valves Matches Malvina Collection	\$329	\$411	\$476	\$493
3-581		Diverter/Flow Control Trim, Cold Use with stop or diverter valves Matches Malvina Collection	\$329	\$411	\$476	\$493
3-593		Diverter/Flow Control Trim Use with stop or diverter valves Matches Ithaca Collection	\$277	\$347	\$421	\$421
3-594		Diverter/Flow Control Trim Use with stop or diverter valves Matches Joffrey Collection	\$275	\$344	\$399	\$413
3-595		Diverter/Flow Control Trim. Arrow Insert Use with stop or diverter valves Matches Metropole Collection	\$253	\$324	\$390	\$390
3-608		Diverter/Flow Control Trim Use with stop or diverter valves Matches Pavani Collection	\$275	\$344	\$399	\$413
3-609		Diverter/Flow Control Trim Use with stop or diverter valves Matches Secant Collection	\$296	\$370	\$429	\$444

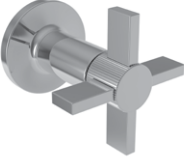
DIVERTER / FLOW CONTROL TRIM

			I	II	III	IV
3-644		Diverter/Flow Control Trim Use with stop or diverter valves Matches Pardees Collection	\$302	\$378	\$465	\$465
3-645		Diverter/Flow Control Trim Use with stop or diverter valves Matches Pardees Collection	\$329	\$411	\$476	\$493
3-646		Diverter/Flow Control Trim Use with stop or diverter valves Matches Clemens Collection	\$290	\$373	\$465	\$465
3-647		Diverter/Flow Control Trim Use with stop or diverter valves Matches Clemens Collection	\$290	\$373	\$465	\$465
3-648		Diverter/Flow Control Trim Use with stop or diverter valves Matches Griffey Collection	\$290	\$373	\$465	\$465
3-649		Diverter/Flow Control Trim Use with stop or diverter valves Matches Griffey Collection	\$290	\$373	\$465	\$465
3-692		Diverter/Flow Control Trim Use with stop or diverter valves Matches Muncy Collection	\$290	\$373	\$465	\$465

DIVERTER / FLOW CONTROL TRIM

			I	II	III	IV
3-693		Diverter/Flow Control Trim Use with stop or diverter valves Matches Muncy Collection	\$290	\$373	\$465	\$465
3-721		Diverter/Flow Control Trim. Lever Handle Use with stop or diverter valves Matches Tolmin Collection	\$257	\$329	\$412	\$412
3-722		Diverter/Flow Control Trim. Cross Handle Use with stop or diverter valves Matches Tolmin Collection	\$257	\$329	\$412	\$412
3-727		3/4" Diverter/Flow Control Trim Use with stop or diverter valves Matches Taft Collection	\$257	\$329	\$412	\$412
30-130		Diverter/Flow Control, Lever Handle Use with stop or diverter valves Matches Kimbell Collection	\$384	\$480	\$557	\$596
30-132		Diverter/Flow Control, Cross Handle Use with stop or diverter valves Matches Kimbell Collection	\$484	\$580	\$657	\$696
20-511		Round Diverter Trim Plate Traditional Optional use up to 2.5" hole	\$247	\$308	\$358	\$370

DIVERTER / FLOW CONTROL TRIM

			I	II	III	IV
20-512		Round Diverter Trim Plate Contemporary Optional use up to 2.5" hole	\$247	\$308	\$358	\$370
20-513		Square Diverter Trim Plate Contemporary Optional use up to 2.5" hole	\$247	\$308	\$358	\$370
20-514		Square Diverter Trim Plate Traditional Optional use up to 2.5" hole	\$247	\$308	\$358	\$370
2-260		3/4" Valve trim extension kit Extends 1-3/8" Please specify finish	\$230	\$288	\$343	\$345
20-146		1/2" Valve Trim Extension Kit Extends 1-3/8" Please specify finish	\$329	\$411	\$476	\$493
I-617		1/2" In-wall 2 & 3 way diverter valve 1 inlet, 3 outlets**	\$359	—	—	—
I-606U		1/2" inlet/outlet stop valve (clockwise off)	\$261	—	—	—
I-607U		3/4" inlet/outlet stop valve (clockwise off)	\$354	—	—	—

DIVERTER / FLOW CONTROL TRIM









		I	II	III	IV	
<u>1/2" in-wall diverter valves* with:</u>						
I-701	 <p>*SEE PAGE 294 FOR HOW TO USE THESE DIVERTERS</p>	3 function with off. 1 inlet, 3 outlets**	\$430	—	—	—
I-702		5 function with share and off. 1 inlet, 3 outlets	\$430	—	—	—
I-703		3 function with pause. 1 inlet, 3 outlets**	\$430	—	—	—
I-704		2 function with off. 1 inlet, 2 outlets**	\$430	—	—	—
I-705		3 function with share and off. 1 inlet, 2 outlets	\$430	—	—	—
I-706		2 function with pause. 1 inlet, 2 outlets**	\$430	—	—	—
I-707		3 function with share (no off). 1 inlet, 2 outlets	\$430	—	—	—

**Cal Green Compliant















Pardees Collection (see page 234)













BP SHOWER TRIM SETS

			I	II	III	IV
REQUIRED ACCESSORY	BP Valve					
PART #	1-685					
						
Pricing	\$503	Newport Brass BP Valve with diverter, 4 port with service stops, universal 1/2" NPT & direct sweat				
Collection	ASTOR	ASTOR & CHESTERFIELD	AYLESBURY	CHESTERFIELD		
PART #	3-912BP	3-922BP	3-2412BP	3-1032BP		
						
Pricing	I \$1142 II \$1428 III \$1656 IV \$1713	I \$1142 II \$1428 III \$1656 IV \$1713	I \$1442 II \$1803 III \$2091 IV \$2163	I \$1142 II \$1428 III \$1656 IV \$1713		
Collection	EAST LINEAR	EAST LINEAR	ITHACA	PAVANI		
PART #	3-992BP	3-1502BP	3-2552BP	3-3102BP		
						
Pricing	I \$1142 II \$1428 III \$1656 IV \$1713	I \$1142 II \$1428 III \$1656 IV \$1713	I \$1687 II \$2278 III \$2534 IV \$2650	I \$1442 II \$1803 III \$2091 IV \$2163		

BP SHOWER TRIM SETS

REQUIRED ACCESSORY	BP Valve			
PART #	1-684			
				
	\$365			
Pricing	Newport Brass BP Valve, 3 port with service stops, universal 1/2" NPT & direct sweat			
Collection	AMISA	ASTOR	ASTOR & CHESTERFIELD	AYLESBURY & JACOBAN
PART #	3-984BP	3-914BP	3-924BP	3-2404BP
				
Pricing	I \$863 II \$1121 III \$1297 IV \$1297	I \$863 II \$1079 III \$1252 IV \$1295	I \$863 II \$1079 III \$1252 IV \$1295	I \$1372 II \$1715 III \$1990 IV \$2058
Collection	AYLESBURY & JACOBAN	CHESTERFIELD	DORRANCE	EAST LINEAR
PART #	3-2414BP	3-1034BP	3-2974BP	3-994BP
				
Pricing	I \$1372 II \$1715 III \$1990 IV \$2058	I \$863 II \$1079 III \$1252 IV \$1295	I \$1279 II \$1721 III \$1988 IV \$2050	I \$863 II \$1079 III \$1252 IV \$1295
Collection	EAST LINEAR	EAST LINEAR	ITHACA	JOFFREY
PART #	3-994LBP	3-1504BP	3-2554BP	3-2574BP
				
Pricing	I \$849 II \$1061 III \$1230 IV \$1273	I \$863 II \$1079 III \$1252 IV \$1295	I \$1372 II \$1733 III \$1990 IV \$2058	I \$1372 II \$1802 III \$2070 IV \$2175

BP SHOWER TRIM SETS

REQUIRED ACCESSORY PART #	BP Valve I-684 				
Pricing	\$365	Newport Brass BP Valve, 3 port with service stops, universal 1/2" NPT & direct sweat			
Collection PART #	PAVANI 3-2494BP 	PAVANI 3-3124BP 	MALVINA 3-3144BP 	METRO 3-2544BP 	
Pricing	I \$1372 II \$1715 III \$1990 IV \$2058	I \$1372 II \$1715 III \$1990 IV \$2058	I \$1279 II \$1721 III \$1988 IV \$2050	I \$1372 II \$1856 III \$2134 IV \$2225	
Collection PART #	METROPOLE 3-1204BP 	MIRO 3-1624BP 	PAVANI 3-3104BP 	PAVANI 3-2484BP 	
Pricing	I \$863 II \$1079 III \$1252 IV \$1295	I \$863 II \$1121 III \$1295 IV \$1295	I \$1372 II \$1715 III \$1990 IV \$2058	I \$1372 II \$1715 III \$1990 IV \$2058	
Collection PART #	SECANT 3-2044BP 	SECANT 3-2564BP 	SECANT 3-2454BP 		
Pricing	I \$1372 II \$1715 III \$1990 IV \$2058	I \$1372 II \$1856 III \$2134 IV \$2225	I \$1372 II \$1715 III \$1990 IV \$2058		

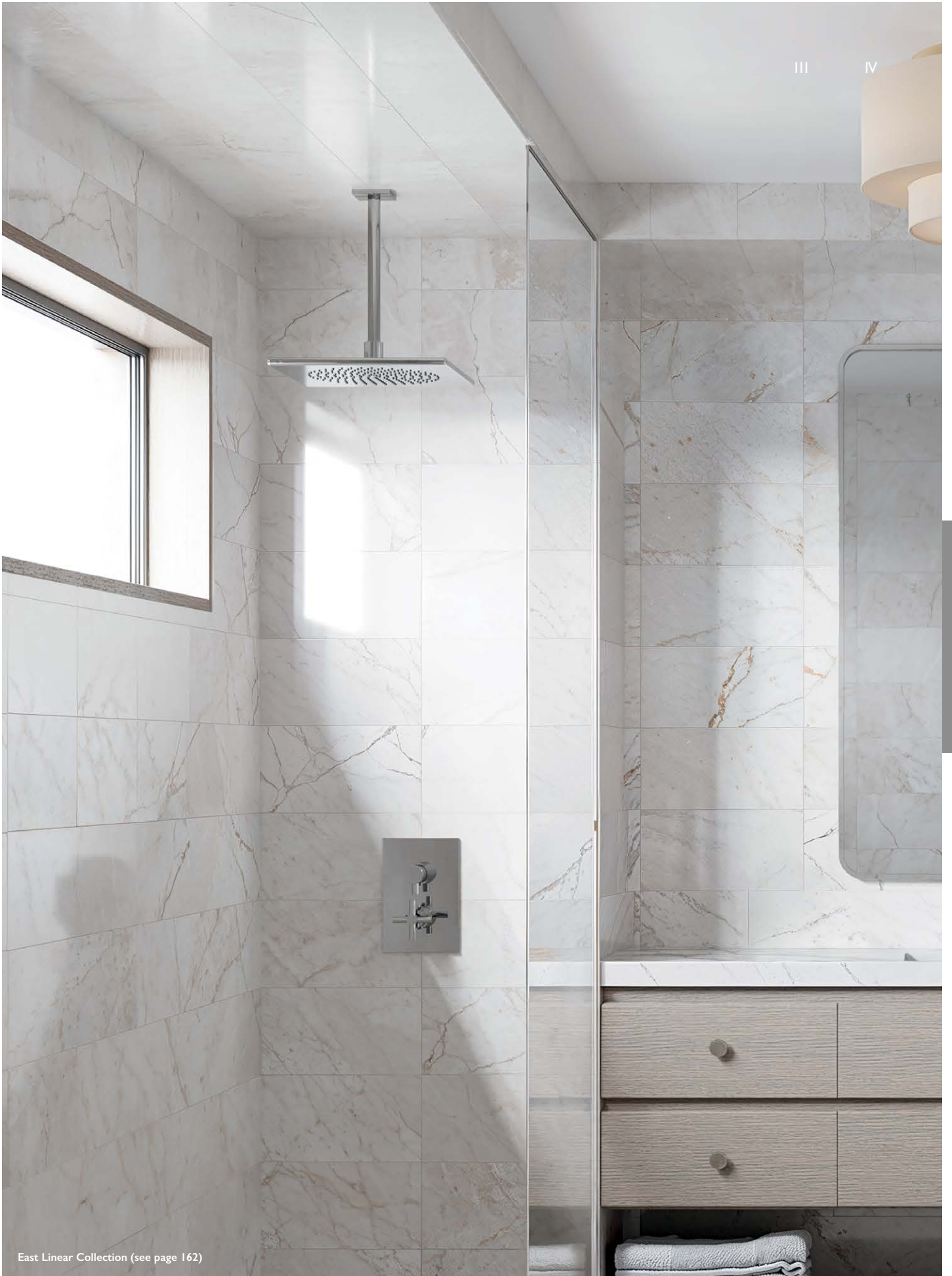

East Linear Collection (see page 162)

BASKETS

11" COMBINATION BASKET

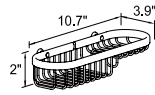
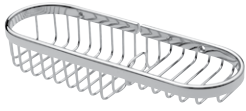

Astor

ITEM	DESCRIPTION	LIST
501-26	Polished Chrome	\$240
501-15	Polished Nickel	\$300
501-15S	Satin Nickel	\$300

11" DEEP TOILETRY BASKET

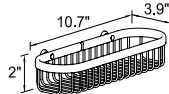
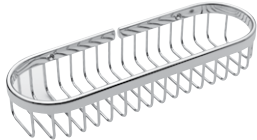

Astor

ITEM	DESCRIPTION	LIST
G502-26	Polished Chrome	\$240
G502-15	Polished Nickel	\$300
G502-15S	Satin Nickel	\$300

18" LARGE COMBINATION BASKET

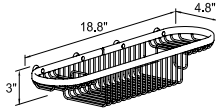

Astor

ITEM	DESCRIPTION	LIST
503L-26	Polished Chrome	\$426
503L-15	Polished Nickel	\$533
503L-15S	Satin Nickel	\$533

CORNER COMBINATION BASKET

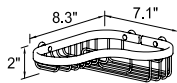

Astor

ITEM	DESCRIPTION	LIST
G504-26	Polished Chrome	\$426
G504-15	Polished Nickel	\$533
G504-15S	Satin Nickel	\$533

LARGE CORNER COMBINATION BASKET

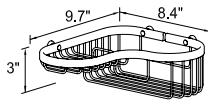
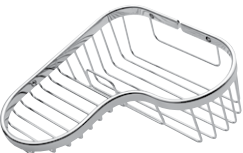

Astor

ITEM	DESCRIPTION	LIST
504L-26	Polished Chrome	\$462
504L-15	Polished Nickel	\$578
504L-15S	Satin Nickel	\$578

LARGE CORNER BASKET

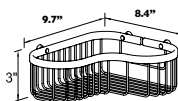
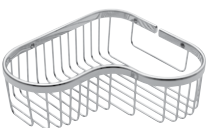

Astor

ITEM	DESCRIPTION	LIST
505L-26	Polished Chrome	\$462
505L-15	Polished Nickel	\$578
505L-15S	Satin Nickel	\$578

BASKETS

RAZOR HOOK

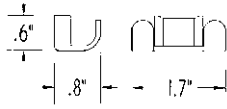

Can be used on Astor only
Does NOT work with East Linear or Secant Baskets/Shelves

Razor hooks must be used in conjunction with basket
Razor hooks cannot be installed directly on the wall

ITEM	DESCRIPTION	LIST
599-26	Polished Chrome	\$59
599-15	Satin Nickel	\$75
599-15S	Satin Nickel	\$75

SOAP BASKET

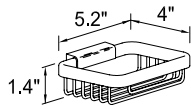

East Linear

ITEM	DESCRIPTION	LIST
550G-56	Flat Black	\$131
550G-26	Polished Chrome	\$105
550G-15	Polished Nickel	\$131
550G-15S	Satin Nickel	\$131

LONG BASKET

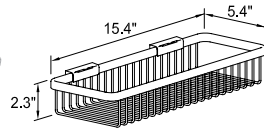
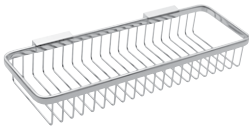

East Linear

ITEM	DESCRIPTION	LIST
552G-56	Flat Black	\$324
552G-26	Polished Chrome	\$263
552G-15	Polished Nickel	\$329
552G-15S	Satin Nickel	\$329

6" CORNER BASKET

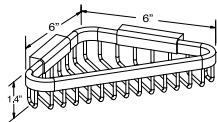

East Linear

ITEM	DESCRIPTION	LIST
553G-56	Flat Black	\$171
553G-26	Polished Chrome	\$137
553G-15	Polished Nickel	\$171
553G-15S	Satin Nickel	\$171

6" CORNER BASKET

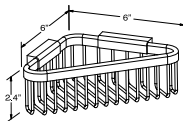
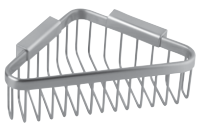

East Linear

ITEM	DESCRIPTION	LIST
553DG-56	Flat Black	\$176
553DG-26	Polished Chrome	\$141
553DG-15	Polished Nickel	\$176
553DGI5S	Satin Nickel	\$176

BASKETS

9" DEEP CORNER BASKET

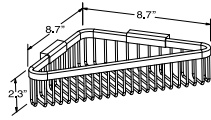

East Linear

ITEM	DESCRIPTION	LIST
554DG-56	Flat Black	\$253
554DG-26	Polished Chrome	\$202
554DG-15	Polished Nickel	\$253
554DG-15S	Satin Nickel	\$253

SHOWER SHELF - SOAP HOLDER

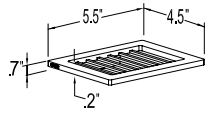

Secant

ITEM	DESCRIPTION	LIST
28500-26	Polished Chrome	\$433
28500-15S	Satin Nickel	\$545

12" SHOWER SHELF

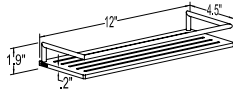
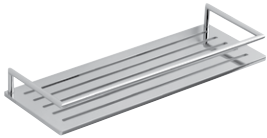

Secant

ITEM	DESCRIPTION	LIST
28502-26	Polished Chrome	\$676
28502-15S	Satin Nickel	\$847

CORNER SHOWER SHELF

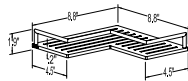
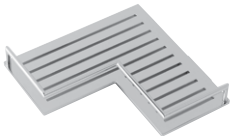

Secant

ITEM	DESCRIPTION	LIST
28505-26	Polished Chrome	\$946
28505-15S	Satin Nickel	\$1183



Kimbell Wall Mount Tub Filler in Venetian Bronze (VB) (see page 203)

GRAB BARS

I II III IV

HOW TO ORDER:

STEP I: Select Decorative Rings and Mounting Kit



920-2400

Decorative Rings and Mounting Kit

\$197

\$246

\$309

\$309

Matches Astor, Aylesbury, Chesterfield, Ithaca, Seaport, Taft and Victoria Collections



990-2400

Decorative Rings and Mounting Kit

\$197

\$246

\$309

\$309

Matches Clemens, East Linear, Griffrey, Kimbell, Muncy, Pardees and Tolmin Collections



1200-2400

Decorative Rings and Mounting Kit

\$197

\$246

\$309

\$325

Matches Metropole Collection



1020-2400

Decorative Rings and Mounting Kit

\$197

\$246

\$309

\$325

Matches Alexandria and Amisa Collections



2480-2400

Decorative Rings and Mounting Kit

\$253

\$317

\$367

\$380

Matches Dorrance and Pavani Collections

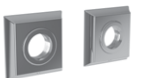

2570-2400

Decorative Rings and Mounting Kit

\$271

\$372

\$428

\$428

Matches Joffrey Collections



2040-2400

Decorative Rings and Mounting Kit

\$271

\$338

\$392

\$406

Matches Malvina and Secant Collections



2400-2400

Decorative Rings and Mounting Kit

\$318

\$430

\$482

\$482

Matches Aylesbury and Jacobean Collections



2440-2400

Decorative Rings and Mounting Kit

\$318

\$430

\$482

\$482

Matches Vander Collections



1600-2400

Decorative Rings and Mounting Kit

\$318

\$430

\$482

\$490



Matches Miro Collections







GRAB BARS



I II III IV



STEP 2: Select Grab Bar Tube



	5080	12" Grab Bar Tube	\$210	\$263	\$305	\$315
	5081	16" Grab Bar Tube	\$235	\$294	\$341	\$353
	5082	18" Grab Bar Tube	\$230	\$292	\$334	\$345
	5083	24" Grab Bar Tube	\$275	\$344	\$399	\$413
	5085	36" Grab Bar Tube	\$405	\$506	\$587	\$607
	5080SQ	12" Grab Bar Tube - Square	\$223	\$278	\$323	\$334
	5081SQ	16" Grab Bar Tube - Square	\$272	\$340	\$394	\$408
	5082SQ	18" Grab Bar Tube - Square	\$299	\$374	\$434	\$448
	5083SQ	24" Grab Bar Tube - Square	\$347	\$434	\$503	\$520
	5085SQ	36" Grab Bar Tube - Square	\$454	\$567	\$658	\$681

920-3942		42" Grab Bar	\$734	\$917	\$1064	\$1101
		<i>Sold as complete unit</i> NOT available in Stainless Steel (20) finish				
						

990-3942		42" Grab Bar	\$734	\$917	\$1064	\$1101
		<i>Sold as complete unit</i> NOT available in Stainless Steel (20) finish				
						









1020-3942		42" Grab Bar	\$734	\$917	\$1064	\$1101
		<i>Sold as complete unit</i> NOT available in Stainless Steel (20) finish				
						

1200-3942		42" Grab Bar	\$734	\$917	\$1064	\$1101
		<i>Sold as complete unit</i> NOT available in Stainless Steel (20) finish				
						

1600-3942		42" Grab Bar	\$847	\$1059	\$1229	\$1271
		<i>Sold as complete unit</i> NOT available in Stainless Steel (20) finish				
						

2040-3942		42" Grab Bar	\$847	\$1059	\$1229	\$1271
		<i>Sold as complete unit</i> NOT available in Stainless Steel (20) finish				
						

GRAB BARS

		I	II	III	IV
2400-3942	 <p>42" Grab Bar</p> <p><i>Sold as complete unit</i> NOT available in Stainless Steel (20) finish</p> 	\$847	\$1059	\$1229	\$1271
2440-3942	 <p>42" Grab Bar</p> <p><i>Sold as complete unit</i> NOT available in Stainless Steel (20) finish</p> 	\$847	\$1059	\$1229	\$1271
2480-3942	 <p>42" Grab Bar</p> <p><i>Sold as complete unit</i> NOT available in Stainless Steel (20) finish</p> 	\$847	\$1059	\$1229	\$1271
2570-3942	 <p>42" Grab Bar</p> <p><i>Sold as complete unit</i> NOT available in Stainless Steel (20) finish</p> 	\$847	\$1059	\$1229	\$1271

SPECIALTY BATHROOM ACCESSORIES

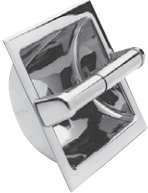
		I	II	III	IV
10-81	 <p>Standing Toilet Tissue Holder Height 22". Base diameter 7-1/2"</p>	\$517	\$646	\$750	\$775
10-89	 <p>Recessed Toilet Tissue Holder Mounting screw holes 3" c-c Wood screws and clamp included Rough in dimensions 5-1/4" x 5-1/4"</p>	\$275	\$344	\$399	\$413

TANK LEVERS

HOW TO ORDER:

STEP 1: ORDER THE MECHANISM WITH YOUR FINISH CHOICE

6-505 + Finish = 6-505-Finish (6-505 + Polished Chrome = 6-505-26)

STEP 2: ORDER THE HANDLE SELECTION WITH YOUR FINISH CHOICE

2-436 + Finish = 2-436-Finish (2-436 + Polished Chrome = 2-436-26)

REQUIRED ACCESSORY			
PART #	6-505		
 <p>The 6-505 rotates into a front, side or angled position, making it compatible with many types of toilets. Works with insulated tanks (Max 5/8" Wall Thickness)</p>			

Collection	AYLESBURY, JACOBAN	CHESTERFIELD	EAST LINEAR	EAST LINEAR
PART #	2-645	2-136	2-111H	20-289
Description	TANK LEVER	TANK LEVER	TANK LEVER	TANK LEVER
				
Pricing	I \$177 III \$257	II \$221 IV \$265	I \$171 III \$247	II \$213 IV \$256
			I \$233 III \$361	II \$297 IV \$375
			I \$233 III \$361	II \$297 IV \$379

Collection	METROPOLE	MIRO	SEAPORT	SEAPORT	SECANT
PART #	2-279	2-436	2-116	2-470	20-406
Description	TANK LEVER	TANK LEVER	TANK LEVER	TANK LEVER	TANK LEVER
					
Pricing	I \$204 III \$296	II \$255 IV \$306	I \$161 III \$233	II \$201 IV \$241	I \$96 III \$207
			I \$96 III \$207	II \$121 IV \$207	I \$272 III \$394
			I \$272 III \$394	II \$340 IV \$408	I \$90 III \$191
					II \$113 IV \$200

TANK LEVERS



Collection	SECANT	
PART #	RP20-407	
Description	TANK LEVER	
		
Pricing	I \$156	II \$195
	III \$227	IV \$234

PART #	500	
Pricing	I \$172	II \$174
	III \$201	IV \$208



Tank Lever for commonly used toilets (8" arm).
 Front mount Solid Brass. May be used with
 Devonshire toilets.

Newport Brass fittings are crafted from solid brass, chosen for its weight, strength, and lasting integrity. This commitment to material is felt in every detail—from the reassuring substance in hand to the quiet confidence of performance over time. Brass is not a surface treatment here; it is the foundation, shaping both the character and longevity of every piece.

Refined through careful machining and finishing, each fitting carries the presence of thoughtful craftsmanship. The result is hardware that does more than complete a space—it anchors it, bringing durability, precision, and a sense of permanence to kitchens and baths designed to endure.

FITTINGS

FITTINGS

NUMERICAL INDEX

CATEGORY	PAGE
FITTINGS - KITCHEN	368
FITTINGS - TUB & SHOWER	369
FITTINGS - TANK & LAVATORY	374







FITTINGS - KITCHEN

			I	II	III	IV
112		Garbage Disposer Flange. Fits most InSinkErator models (also KitchenAid, Emerson, Kenmore and Grainger)	\$109	\$153	\$181	\$190
112A		Deep Garbage Disposer Flange Fits farm style and fireclay sinks 2-1/2" deep	\$130	\$164	\$199	\$209
113		Garbage Disposer Stopper Fits No. 112 & 112A above	\$66	\$106	\$129	\$135
120		Large Basket Strainer, Wing Nut Locking Style, with nuts and washers Fits 3-1/2" opening.	\$250	\$290	\$339	\$356
121		Large Basket Strainer, Post Type, with nuts and washers. Fits 3-1/2" opening	\$217	\$255	\$277	\$291
122		Large Brass Basket Strainer, Post Type, with strainer and nuts Fits 3-1/2" opening	\$194	\$221	\$255	\$268
122LS		Same as above with 1" extension	\$207	\$229	\$265	\$278







FITTINGS - TUB & SHOWER

			I	II	III	IV
230		3-1/4" Drain Trim Set. Consists of grill, crown and screws Fits Plumbing Products drains	\$55	\$72	\$86	\$90
231		Deluxe Trim Set. Consists of grill, crown, screws, No. 230 Drain Trim Set	\$110	\$141	\$182	\$191
236		Fits Casper Strainer No. 129, Sioux Chief, Intercon, Prier Brass and B&K. 4-1/4" O.D. 2-7/8" prong to prong	\$69	\$81	\$94	\$99
238		Solid Brass Strainer for Plastic Oddities, Prier Brass, Richmond Foundry, Sioux Chief, C.P. Industries and Rapidfit shower drains 4" diameter. 3-3/8" c-c screw holes	\$94	\$110	\$128	\$134
III-2961		Pivoting Waste & Overflow. Lift & Turn Style with 2-hole faceplate Maximum make-up 22-5/8" All Parts Polished For Use with Tubs on Legs	\$939	\$1172	\$1586	\$1665
III-2962		Pivoting Waste & Overflow Toe Activated Style with 2-hole faceplate Maximum make-up 22-5/8" All Parts Polished For Use with Tubs on Legs	\$939	\$1172	\$1586	\$1665
257		Waste & Overflow, Lift & Turn Style with Maximum make-up 22" All Parts Polished For Use With Tubs On Legs	\$666	\$898	\$1079	\$1133





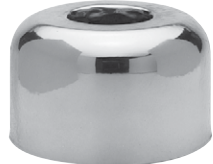

FITTINGS - TUB & SHOWER

			I	II	III	IV
255		Toe-Activated Waste & Overflow Includes No. 265 Faceplate and No. 272 Tub Drain Other parts are in ABS plastic. 22" high, 6" shoe Not assembled Can be cut for lesser height	\$305	\$369	\$415	\$436
265		Faceplate for Waste & Overflow 1 hole with screws Solid Brass 3" overall	\$84	\$88	\$110	\$116
266		Faceplate for Waste & Overflow 2 holes with screws Solid Brass 3" overall	\$84	\$104	\$124	\$130
267		Round Trip Lever Faceplate with screws Solid Brass 3" overall	\$87	\$116	\$141	\$148
270		Lift & Turn Bath Plug 1-1/2" IPS coarse thread	\$116	\$141	\$155	\$163
272		Toe-Activated Tub Drain 1-1/2" coarse thread strainer shoes, including Gerber, Rapid Fit and Watco Solid Brass	\$141	\$181	\$219	\$230
273		Toe-Activated Drain Kit One hole. Includes Nos. 272 & 265	\$187	\$233	\$275	\$289

FITTINGS - TUB & SHOWER

			I	II	III	IV
274		Toe-Activated Drain Kit Two holes. Includes Nos. 272 & 266	\$215	\$265	\$311	\$327
275		Trip Lever Drain Kit	\$124	\$155	\$208	\$218
276		Toe-Activated Drain Kit with ABS shoe & Overflow elbow. Includes Nos. 272 & 265	\$208	\$265	\$296	\$311
301-2		1-1/4" x 1-1/4" contemporary P-Trap Comes with 1-1/4" x 1-1/2" bushing adapter for connection to 1-1/2" sewer line. Wall flange sold separately	\$415	\$570	\$647	\$679
3016		301-2 packaged with 314 flange	\$455	\$638	\$720	\$756
3013		"P" Trap Kit. Includes 1-1/2" "P" Trap and High Box Flange Packed in one box	\$279	\$347	\$399	\$419
3013-1		Same as 3013 only the wall bend tube is 24" long	\$387	\$483	\$551	\$579
3014		"P" Trap Kit. Includes 1-1/4" "P" Trap and High Box Flange Packed in one box	\$257	\$322	\$374	\$393
3014-1		Same as 3014 only the wall bend tube is 24" long	\$387	\$483	\$551	\$579
314		High Box Flange. Deep. For 1-1/4" O.D. 1-1/4" I.D. x 3" O.D. x 1-3/4" HT	\$66	\$82	\$95	\$100

FITTINGS - TUB & SHOWER

			I	II	III	IV
321		P.O. Plug with Flat Strainer Plate Fits 1-5/8" to 1-3/4" opening. Has Overflow holes Tailpiece 1-1/4" O.D.	\$143	\$197	\$218	\$229
3212		Same as 321 fully Finished	\$227	\$273	\$313	\$329
3211		Same as 321 with no Overflow	\$143	\$197	\$218	\$229
3213		Same as 321 I fully Finished	\$227	\$273	\$313	\$329
499		Dome Cap Drain with Overflow	\$157	\$226	\$240	\$252
499-1		Same as 499 without Overflow	\$157	\$226	\$240	\$252
499-2		Same as 499 fully Finished	\$276	\$372	\$424	\$445
499-3		Same as 499-1 fully Finished	\$276	\$372	\$424	\$445
324		Lavatory Pop-Up Drain Assembly with no Overflow. Can be used with glass sinks Fits 1-5/8" to 1-3/4" opening Completely Finished	\$280	\$374	\$429	\$450
325		Lavatory Pop-Up Drain Assembly with Overflow. Fits 1-5/8" to 1-3/4" opening	\$195	\$265	\$303	\$318
325 ¹		Pop-Up Lift Rod Extension Kit Available in raw brass only. Fits pop-up rod or horizontal lift rod on pop-up assembly Non-Finished Item	\$65	-	-	-
326		Full Lavatory Pop-Up Drain Assembly with Overflow. Fits 1-5/8" to 1-3/4" opening Completely Finished	\$269	\$351	\$404	\$424
330		Push Pop-Up Assembly Fits 1-5/8" to 1-3/4" opening Has Overflow holes Tailpiece 1-1/4" O.D.	\$177	\$249	\$285	\$299
330 ²		Same as 330 above fully Finished	\$239	\$288	\$328	\$344
330 ¹		Same as 330 no Overflow	\$195	\$265	\$303	\$318
330 ³		Same as 330 ¹ fully Finished	\$239	\$288	\$328	\$344
372						

FITTINGS - TUB & SHOWER

			I	II	III	IV
327		1-1/4" x 8" Tail Piece for lavatory drain (Works only with #324, #325, and #326)	\$114	\$135	\$150	\$158
328		1-1/4" O.D. x 8" Slip Joint Extension Tube Works for all 1-1/4" drains	\$130	\$163	\$181	\$190
404X		Angle Valve with Cross Handle Inlet 3/8" IPS. Outlet 3/8" O.D. Compression	\$143	\$188	\$215	\$226







FITTINGS - TANK & LAVATORY

			I	II	III	IV
403		Angle Valve Inlet 1/2" Compression Outlet 3/8" O.D. Compression	\$135	\$172	\$206	\$216
403X		Angle Valve with Cross Handle Inlet 1/2" Compression Outlet 3/8" O.D. Compression	\$161	\$215	\$237	\$249
403-1		1/4" Turn Ceramic Disk Angle valve, contemporary style with lever handle Inlet 1/2" Compression Outlet 3/8" Compression	\$272	\$369	\$421	\$442
403-3		1/4" Turn Ceramic Disk Angle valve square contemporary style Inlet 1/2" Compression Outlet 3/8" Compression	\$332	\$407	\$452	\$475
403X-1		1/4" Turn Ceramic Disk Angle valve contemporary style with cross handle Inlet 1/2" Compression Outlet 3/8" Compression	\$340	\$401	\$452	\$475
412		Straight Valve Inlet 1/2" Compression Outlet 3/8" O.D. Compression	\$130	\$163	\$175	\$184
416		Angle Valve 1/2" sweat x 3/8" O.D. Compression with 1 1/16" bell flange	\$171	\$211	\$253	\$266
416X		Angle Valve with Cross Handle 1/2" sweat x 3/8" O.D. Compression with 1 1/16" bell flange	\$211	\$285	\$319	\$335

FITTINGS - TANK & LAVATORY

			I	II	III	IV
417		Straight Valve. 1/2" sweat x 3/8" Compression with 1 1/16" bell flange	\$171	\$226	\$255	\$268
417X		Straight Valve with Cross Handle 1/2" sweat x 3/8" O.D. Compression with 1 1/16" bell flange	\$226	\$307	\$351	\$369
432		3/8" O.D. x 20" Bullnose Rigid Supply Tube	\$75	\$88	\$105	\$110
435		3/8" O.D. x 12" Flat Head Rigid Supply Tube	\$62	\$82	\$94	\$99
436		3/8" O.D. x 20" Flat Head Rigid Supply Tube	\$66	\$94	\$99	\$104
441		Brass Flange Sure Grip. For 5/8" O.D. Same as 1/2" Compression 5/8" I.D. x 2-1/2" O.D. x 13/32" HT	\$44	\$54	\$62	\$65
482		Toilet Supply Kit 1/2" Compression x 3/8" Includes: (1) 403: Angle Valve. Inlet 1/2" Compression* Outlet 3/8" O.D. Compression (1) 436: 3/8" O.D. x 20" Flat Head Rigid Supply Tube (1) 441: Brass Flange. Sure Grip. For 5/8" O.D. Same as 1/2" Compression 5/8" I.D. x 2-1/2" O.D. x 13/32" HT	\$190	\$241	\$279	\$293
482X		Toilet Supply Kit with Cross Handle 1/2" Compression x 3/8" Includes: (1) 403X: Angle Valve with Cross Handle Inlet 1/2" Compression. Outlet 3/8" O.D. Compression (1) 436: 3/8" O.D. x 20" Flat Head Rigid Supply Tube (1) 441: Brass Flange. Sure Grip. For 5/8" O.D. Same as 1/2" Compression 5/8" I.D. x 2-1/2" O.D. x 13/32" HT	\$226	\$307	\$344	\$361

FITTINGS - TANK & LAVATORY

		I	II	III	IV	
482-I		Toilet Supply Kit 1/2" Compression x 3/8" O.D. Includes: (1) 403-I: 1/4" Turn Ceramic disk. Angle valve, contemporary style with lever handle Inlet 1/2" Compression. Outlet 3/8" Compression (1) 436: 3/8" O.D. x 20" Flat Head Rigid Supply Tube (1) 441: Brass Flange. Sure Grip. For 5/8" O.D. Same as 1/2" Compression 5/8" I.D. x 2-1/2" O.D. x 13/32" HT	\$339	\$464	\$535	\$562
482X-I		Toilet Supply Kit 1/2" Compression x 3/8" O.D. Includes: (1) 403X-I: 1/4" turn ceramic disk Angle valve contemporary style with cross handle Inlet 1/2" Compression Outlet 3/8" Compression (1) 436: 3/8" O.D. x 20" Flat Head Rigid Supply Tube (1) 441: Brass Flange. Sure Grip. For 5/8" O.D. Same as 1/2" Compression 5/8" I.D. x 2-1/2" O.D. x 13/32" HT	\$361	\$487	\$555	\$583
495		Toilet Supply Kit 1/2" Compression x 3/8" O.D. Includes: (1) 4403: Angle Valve. Inlet 1/2" Compression Outlet 3/8" O.D. Compression (1) 435: 3/8" O.D. x 12" Flat Head Rigid Supply Tube (1) 441: Brass Flange. Sure Grip. For 5/8" O.D. Same as 1/2" Compression 5/8" I.D. x 2-1/2" O.D. x 13/32" HT	\$184	\$239	\$306	\$321
495X		Toilet Supply Kit with Cross Handle 1/2" Compression x 3/8" Includes: (1) 403X: Angle Valve with Cross Handle Outlet 3/8" O.D. Compression (1) 435: 3/8" O.D. x 12" Flat Head Rigid Supply Tube (1) 441: Brass Flange. Sure Grip. For 5/8" O.D. Same as 1/2" Compression 5/8" I.D. x 2-1/2" O.D. x 13/32" HT	\$211	\$307	\$357	\$375
493		Lavatory Supply Kit 1/2" Compression x 3/8" Includes: (2) 403: Angle Valve. Inlet 1/2" Compression Outlet 3/8" O.D. Compression (2) 432: 3/8" O.D. x 20" Bullnose Rigid Supply Tube (2) 441: Brass Flange. Sure Grip. For 5/8" O.D. Same as 1/2" Compression 5/8" I.D. x 2-1/2" O.D. x 13/32" HT	\$361	\$542	\$602	\$632
493X		Lavatory Supply Kit with Cross Handles 1/2" Compression x 3/8" Includes: (2) 403X: Angle Valve with Cross Handle Inlet 1/2" Compression Outlet 3/8" O.D. Compression (2) 432: 3/8" O.D. x 20" Bullnose Rigid Supply Tube (2) 441: Brass Flange. Sure Grip. For 5/8" O.D. Same as 1/2" Compression 5/8" I.D. x 2-1/2" O.D. x 13/32" HT	\$407	\$570	\$661	\$694
493-I		Lavatory Supply Kit 1/2" Compression x 3/8" O.D. Includes: (2) 403-I: 1/4" Turn Ceramic disk Angle valve contemporary style with lever handle Inlet 1/2" Compression Outlet 3/8" Compression (2) 432: 3/8" O.D. x 20" Bullnose Rigid Supply Tub (2) 441: Brass Flange. Sure Grip. For 5/8" O.D. Same as 1/2" Compression 5/8" I.D. x 2-1/2" O.D. x 13/32" HT	\$641	\$884	\$1016	\$1067

FITTINGS - TANK & LAVATORY

		I	II	III	IV
493X-1	 <p>Lavatory Supply Kit 1/2" Compression x 3/8" O.D. Includes: (2) 403X-1: 1/4" turn ceramic disk Angle valve contemporary style with cross handle Inlet 1/2" Compression, Outlet 3/8" Compression (2) 432: 3/8" O.D. x 20" Bullnose Rigid Supply Tube (2) 441: Brass Flange. Sure Grip. For 5/8" O.D. Same as 1/2" Compression 5/8" I.D. x 2-1/2" O.D. x 13/32" HT</p>	\$672	\$903	\$1050	\$1103

TERMS & CONDITIONS

Sales by Brasstech, Inc ("Seller") to purchaser ("Buyer") are governed by these Terms & Conditions, which may not be varied by any unilateral writing of the Buyer without the expressed written consent of the Seller. Our acceptance of your order is conditioned upon the application of these terms and conditions to the order. Any terms and conditions that you may propose in connection with your order that are additional or different from these terms and conditions are deemed material and are hereby rejected.

1. PRICES:

Prices are subject to change without notice and are exclusive of any shipping, delivery, packaging or handling charges that might apply.

2. TERMS OF DELIVERY:

Seller's products ("Products") are offered Ex-Works Brasstech, Inc., unless otherwise specifically agreed in writing. Risk of loss of Products shall pass to Buyer upon delivery to carrier at place of shipment. Title shall also pass to Buyer upon delivery thereof, subject to our rights under our purchase money security interest pursuant to paragraph 3(c) below. Carrier acts as Buyer's agent. Unless we expressly authorize in our sole discretion otherwise, all Products will be shipped to Buyer's approved showroom location or to a location within Buyer's local trade area.

3. CLAIMS:

(a) Nonconforming orders: Buyer shall submit to Seller any and all claims for nonconforming delivery of Products by written notice to Seller within fourteen (14) days of receipt of Products. Seller's occasional acceptance of claims made beyond the 14-day period does not constitute a waiver of the 14-day requirement. (b) Damages: Upon delivery of the Products, Buyer should examine the package for damage. Any damage should be noted on the carrier's delivery receipt before signing. In the event of apparent or concealed damage or shortage, Buyer should retain all packaging and file a claim with the carrier. **SELLER'S RESPONSIBILITY CEASES WHEN THE PRODUCTS ARE DELIVERED IN GOOD CONDITION TO THE CARRIER.**

4. RETURNS:

Effective on orders placed on or after July 1, 2009, the following Return Policy is in place for all Brasstech, Inc. products including products branded: Brasstech®, Newport Brass®, GINGER® and Newport 365:

- All non-defective returns are subject to a 25% restocking fee.
- Returns of non-defective products are subject to a 15% re-boxing fee, to be applied at the discretion of the company, if the product packaging is damaged.
- All returns due to a Brasstech, Inc. error or non-conforming products are subject to a 0% restocking fee.
- RGA (Return Goods Authorization) requests will be accepted up to 180 days from shipment of the product.
- Living finishes are non-returnable.
- Mirrors - returns are permitted for nonconforming product only.
- Special order items and finishes are non-returnable.

5. QUOTATIONS:

All quotations will provide an Estimated Time of Delivery (ETD). The ETD is offered as a best estimate of the anticipated delivery time, which the Seller will attempt to meet. It is expressly stated that the ETD is not binding upon Seller and does not provide the basis for consequential or other damages for delay.

6. CHARGES:

- (A) RETURNED CHECK CHARGE: \$50.
- (B) HANDLING CHARGE: HANDLING CHARGES WILL APPLY.
- (C) RESTOCKING CHARGE: 25% OF INVOICED VALUE, PER 5 ABOVE.
- (D) REBOXING CHARGE: 15% OF INVOICED VALUE, PER 5 ABOVE.

7. BUYER'S SPECIFICATIONS:

If the Products sold hereunder are to be manufactured according to the Buyer's specifications, Buyer shall defend, hold harmless, and indemnify Seller against any claims, damages, suits, proceedings, liabilities, costs or attorney's fees incurred in relation to any claim for patent, copyright, trademark or other intellectual property interest infringement or product design defect.

8. FORCE MAJEURE:

Seller shall not be liable for any delay in delivery or for non-delivery, in whole or in part, caused by the occurrence of any contingency beyond the control either of Seller or of suppliers to the Seller, including but not limited to failure or delay in transportation, acts of any government or any agency or subdivision thereof, judicial action, labor, fuel, raw material or machinery or technical failure. If any contingency occurs, Seller may allocate production and deliveries among Seller's customers.

9. CREDIT APPROVAL:

Acceptance of your order and shipment and delivery of Products shall at all times be subject to the approval of Seller's credit department and Seller may at any time decline to make any shipment or delivery except upon receipt of payment in advance or upon terms and conditions or security satisfactory to Seller. Seller is entitled to recover costs and attorney's fees in the enforcement or defense of any rights under any order. Interest accrues on all past-due accounts at the maximum rate of interest allowed by law.

10. SELLER'S INTELLECTUAL PROPERTY:

Buyer does not and shall not acquire ownership or any rights in Seller's patents, inventions, technical data, copyrights, trademarks or other intellectual property rights under any order; regardless of when such patents, inventions, technical data or other intellectual property rights may be or have been issued, conceived, generated, or produced. All Seller patents, information, technical data, copyrights, trademarks and other intellectual property rights are reserved by Seller; and the same shall not be reproduced or used by Buyer for any purpose whatsoever without Seller's written permission.

11. GOVERNING LAW:

All orders shall be construed, interpreted and the rights of the parties determined in accordance with the laws of the State of Delaware.

12. LIMITATIONS ON ACTIONS AND LIABILITY:

The statute of limitations applicable to all Buyer's claims arising under this agreement shall be one year from the date the claim accrues. In no event shall Seller be liable for incidental, indirect, special or consequential damages, whether based upon warranty, breach of contract, negligence, strict liability or any other legal theory.

13. ENTIRE AGREEMENT:

These Terms and Conditions and Seller's dealer policies published from time to time by Seller contain the entire agreement of the parties relating to the subject matter hereof and may not be waived, changed, modified, extended or discharged orally but only by agreement in writing and signed by the party against whom enforcement of any such waiver, charge, modification, extension or discharge is sought. If you have a current separate written dealer agreement with Seller ("Dealer Agreement"), the provisions of the Dealer Agreement will apply to all orders placed during the effective term of the Dealer Agreement, and to the extent that these Terms and Conditions conflict with the provisions of any such Dealer Agreement, the provisions of the Dealer Agreement will control.

14: All allowances, rebates, and amounts under other programs offered to you by Seller from time to time (collectively "Programs") are payable only if Customer's accounts (including those of your subsidiaries and affiliates) are current with all Masco Corporation subsidiaries and affiliates. If the accounts are not current, Programs are considered not earned or payable. In addition, Programs are not earned or payable if the ratings issued by any agency, such as S&P, Moody's, or Fitch, relating to Customer's company, parent, subsidiaries, or affiliates are lower than investment grade quality. Any earned payment may be withheld or be used to satisfy any of the accounts or other obligations to a Masco subsidiary or affiliate.

ECOA NOTICE

The federal Equal Credit Opportunity Act prohibits creditors from discriminating against credit applicants on the basis of race, color, religion, national origin, sex, marital status, age (provided that the applicant has the capacity to enter into a binding contract); because all or part of the applicant's income derives from any public assistance program; or because the applicant has in good faith exercised any right under the Consumer Protection Credit Act. The federal agency that administers compliance with this law concerning this credit is the Federal Trade Commission, Division of Credit Practices, 6th and Pennsylvania Avenue NW, Washington DC 20580. For CA residents: An applicant, if married, may apply for a separate account. For OH residents: The Ohio laws against discrimination require that all creditors make credit equally available to all credit worthy customers, and that credit reporting agencies maintain separate credit histories on each individual upon request. The Ohio civil rights commission administers compliance with this law.

Please refer to our website for the most current Terms & Conditions.

LIMITED WARRANTY

Brasstech, Inc. warrants to the original consumer residential purchaser ("Original Purchaser") that if a product in its; Newport Brass®, Brasstech®, or GINGER® lines of products ("Product") is confirmed upon inspection to be defective in materials or workmanship during the warranty periods described below, Brasstech, Inc. will, at its option, either repair or provide one-time replacement of the Product with a similar current model of the Product. If repair or replacement is not commercially practical or cannot be made in a timely manner, then Brasstech, Inc. will provide a refund for the Product. This warranty is non-transferable.

WARRANTY PERIODS AND COVERAGE PRODUCT FINISHES

- PVD and Polished Chrome (26) finishes on Products other than Drains and Shower rods are warranted as long as the Original Purchaser owns their home.
- "Living" finishes have no warranty*.
- Shower rods, porcelain parts and glass parts have no finish warranty.
- Mirror products will be warranted from desilvering for two (2) years from the date that the product is received by the original purchaser or their authorized representative as long as desilvering is not due to chemical contact. See maintenance section for proper cleaning instructions.
- All other finishes are warranted for ten (10) years from the date that the product is received by the original purchaser or their authorized representative.

DRAIN FINISHES

- Polished Chrome (26) and PVD finishes on kitchen, bath or lavatory drains including drain baskets and components are warranted for one (1) year from the date that the product is received by the original purchaser or their authorized representative.
- All other Drain finishes have no warranty.

FUNCTIONALITY

- All Product parts except valves are warranted for ten (10) years from the date that the product is received by the original purchaser or their authorized representative.
- Ceramic disc valves for the lavatory faucet and roman tub are warranted for as long as the Original Purchaser owns the home.
- All other valves (balance pressure, thermostatic, etc.) are warranted for one (1) year from the date that the product is received by the original purchaser or their authorized representative.
- Lights have no functional warranty. Soap / Lotion pump mechanisms are warranted for one (1) year from the date that the product is received by the original purchaser or their authorized representative. Shower rods, porcelain parts and glass parts have no functional warranty.
- Hot water tanks are warranted for one (1) year from the date that the product is received by the original purchaser or their authorized representative.
- Products used on the exterior of a home carry a one (1) year finish and functionality warranty from the date that the product is received by the original purchaser or their authorized representative.
- Products sold for use as display items are not meant for resale and are not covered under any functional or finish warranty.

LIMITATION OF SPECIAL, INCIDENTAL OR CONSEQUENTIAL DAMAGES

Please note that some states/provinces including Quebec do not allow the exclusion or limitation of special, incidental or consequential damages, so the below limitations and exclusions may not apply to you. BRASSTECH, INC. SHALL NOT BE LIABLE FOR ANY SPECIAL, INCIDENTAL OR CONSEQUENTIAL DAMAGES (INCLUDING LABOR CHARGES TO REPAIR, REPLACE, INSTALL OR REMOVE THIS PRODUCT), WHETHER ARISING OUT OF BREACH OF ANY EXPRESS OR IMPLIED WARRANTY, BREACH OF CONTRACT, TORT, OR OTHERWISE. BRASSTECH, INC. SHALL NOT BE LIABLE FOR ANY DAMAGE TO THE PRODUCT RESULTING FROM NORMAL WEAR AND TEAR, OUTDOOR USE, MISUSE (INCLUDING USE OF THE PRODUCT FOR AN UNINTENDED APPLICATION), ABUSE, HARD WATER, IMPROPER STORAGE, IMPROPER HANDLING, IMPROPER INSTALLATION***, IMPROPER MAINTENANCE**, OR OTHER USES OTHER THAN NORMAL HOUSEHOLD USAGE.

LIMITATION ON DURATION OF IMPLIED WARRANTIES

Please note that some states/provinces including Quebec do not allow limitations on how long an implied Warranty lasts, so limitations may not apply to you. TO THE EXTENT PERMITTED BY LAW, ANY IMPLIED WARRANTY, INCLUDING THE IMPLIED WARRANTIES OF MERCHANTABILITY AND OF FITNESS FOR A PARTICULAR PURPOSE, IS LIMITED TO THE STATUTORY PERIOD OR THE DURATION OF THIS WARRANTY WHICHEVER IS SHORTER.

WARRANTY SERVICE

To obtain service under this Warranty, please contact your Product dealer. If you are unable to locate your dealer, please call 949-417-5207 or access the Newport Brass, Inc. website at newportbrass.com. Proof of purchase is required for the dealer to issue credit to the consumer. The dealer must be an authorized dealer and the product must be purchased in the original manufacturer's packaging (display items excluded).

ADDITIONAL RIGHTS

This Warranty gives you specific legal rights, and you may have other rights which vary by state and/or province.

PRODUCT CARE

Simple care is all that is needed in maintaining this product. Abrasive cleansers, detergents and silver or brass polish may result in damage to the finish and therefore should not be used. To clean, simply wipe with a soft, water dampened cloth. Hand, deck and wall shower sprays feature easy-cleaning jets. The jets should be cleaned periodically by rubbing your thumb or a damp cloth across the jets to loosen mineral deposits. Run the shower spray briefly to purge the loosened deposits.

* UNCOATED AND LIVING FINISHES

Uncoated and Living finishes such as Uncoated Polished Brass (03N) and Weathered Copper (08W) do naturally weather and change color over time. Living and uncoated finishes are not warranted.

** MAINTENANCE

Proper maintenance is required to preserve all finishes. Do not use any abrasive cleaners, alcohol, ammonia, detergents, or brass or silver polish on the Products. For complete care requirements and recommendations, please visit our website at www.brasstech.com.

*** PROPER INSTALLATION

Products must be installed in accordance with the manufacturer's installation instructions supplied with the Products. For example, pipes must be flushed before faucet installations because solder and other debris may damage ceramic discs. You may also call 949-417-5207 for copies of the installation instructions. Many of our installation instructions are also available on our website, www.brasstech.com.

**** COMMERCIAL PURCHASERS

Brasstech, Inc. extends the above limited warranty to purchasers of Products for industrial, commercial and business use upon the same terms and conditions and exclusions applicable to residential purchasers, except that the finish and functionality warranty periods are reduced to a period of one (1) year from the date that the product is received by the original purchaser or their authorized representative. ADDITIONALLY, with respect to commercial purchasers, all implied warranties, including the implied warranties of merchantability and fitness for a particular purpose are excluded and disclaimed.

NUMERICAL PARTS INDEX

PART	I	II	III	IV	PAGE
1-339	\$434				122
1-355	\$233				297
1-356	\$233				297
1-357	\$233				297
1-358	\$233				297
1-378	\$549				122
1-469	\$705				168
1-478	\$233				297
1-479	\$233				297
1-480	\$233				297
1-481	\$233				297
1-482	\$65				297
1-483	\$565				168
1-500U	\$477				115
1-502	\$564				120
1-503	\$1,134				120
1-506	\$564				111
1-507	\$1,134				111
1-532U	\$477				120
1-540	\$1,020				112
1-570	\$1,134				183
1-586	\$564				283
1-587	\$1,134				284
1-606U	\$261				347
1-607U	\$354				347
1-617	\$359				347
1-636	\$564				183
1-665	\$564				157
1-666	\$1,134				157
1-684	\$365				111
1-685	\$503				111
1-697	\$564				152
1-698	\$1,134				152
1-701	\$430				348
1-702	\$430				348
1-703	\$430				348
1-704	\$430				348
1-705	\$430				348
1-706	\$430				348
1-707	\$430				348
1-741	\$686				338
1-742	\$821				338

PART	I	II	III	IV	PAGE
1-743	\$898				338
1-744	\$898				338
1-745	\$821				338
2-IIIH	\$233	\$297	\$361	\$375	174
2-116	\$96	\$121	\$207	\$207	254
2-136	\$171	\$213	\$247	\$256	148
2-144	\$277	\$347	\$402	\$416	123
2-221	\$150	\$187	\$217	\$224	314
2-250	\$289	\$362	\$419	\$434	111
2-260	\$230	\$288	\$343	\$345	347
2-279	\$204	\$255	\$296	\$306	220
2-332	\$150	\$187	\$217	\$224	314
2-436	\$161	\$201	\$233	\$241	226
2-470	\$272	\$340	\$394	\$408	254
2-503	\$56	\$70	\$81	\$84	314
2-564	\$312	\$390	\$453	\$468	224
2-640	\$150	\$187	\$217	\$224	314
2-645	\$177	\$221	\$257	\$265	137
2-734	\$378	\$472	\$547	\$566	122
3-1003	\$944	\$1,189	\$1,369	\$1,416	141
3-1006	\$1,520	\$1,900	\$2,204	\$2,280	142
3-1007	\$1,820	\$2,275	\$2,639	\$2,730	142
3-1026	\$1,836	\$2,295	\$2,663	\$2,754	115
3-1027	\$2,136	\$2,670	\$3,098	\$3,204	115
3-1031	\$944	\$1,227	\$1,472	\$1,472	140
3-1036	\$1,246	\$1,558	\$1,807	\$1,869	141
3-1037	\$1,820	\$2,275	\$2,639	\$2,730	142
3-1096	\$1,836	\$2,295	\$2,663	\$2,754	111
3-1097	\$2,136	\$2,692	\$3,108	\$3,204	111
3-1201	\$944	\$1,180	\$1,369	\$1,416	214
3-1205	\$1,090	\$1,363	\$1,581	\$1,635	216
3-1206	\$1,520	\$1,900	\$2,204	\$2,280	215
3-1207	\$1,820	\$2,275	\$2,639	\$2,730	215
3-1221	\$944	\$1,180	\$1,369	\$1,416	215
3-1231	\$1,011	\$1,417	\$1,698	\$1,698	215
1233-1	\$1,372	\$1,781	\$2,048	\$2,058	214
3-1236	\$1,520	\$1,917	\$2,213	\$2,280	215
3-1237	\$1,920	\$2,418	\$2,792	\$2,880	215
3-1501	\$944	\$1,180	\$1,369	\$1,416	165
3-1626	\$1,520	\$1,900	\$2,204	\$2,280	223
3-1627	\$1,820	\$2,275	\$2,639	\$2,730	223
3-1746	\$1,836	\$2,295	\$2,663	\$2,754	251

PART	I	II	III	IV	PAGE
3-1747	\$2,136	\$2,670	\$3,098	\$3,204	251
3-1761	\$944	\$1,180	\$1,369	\$1,416	283
3-1766	\$1,836	\$2,295	\$2,663	\$2,754	283
3-1767	\$2,136	\$2,670	\$3,098	\$3,204	284
3-1771	\$944	\$1,180	\$1,369	\$1,416	283
3-1775	\$1,090	\$1,363	\$1,581	\$1,635	284
3-1776	\$1,836	\$2,295	\$2,663	\$2,754	283
3-1777	\$2,136	\$2,670	\$3,098	\$3,204	284
3-1505	\$1,090	\$1,363	\$1,581	\$1,635	167
3-1625	\$1,090	\$1,363	\$1,581	\$1,635	223
3-2041	\$1,163	\$1,454	\$1,687	\$1,745	259
3-2045	\$1,090	\$1,363	\$1,581	\$1,635	260
3-2046	\$1,520	\$1,900	\$2,204	\$2,280	259
3-2047	\$1,820	\$2,275	\$2,639	\$2,730	260
3-2061	\$1,163	\$1,454	\$1,687	\$1,745	259
3-2401	\$944	\$1,180	\$1,369	\$1,416	130
3-2411	\$944	\$1,180	\$1,369	\$1,416	130
3-2415	\$1,090	\$1,363	\$1,581	\$1,635	131
3-2416	\$1,520	\$1,900	\$2,204	\$2,280	130
3-2417	\$1,820	\$2,275	\$2,639	\$2,730	131
3-2441	\$944	\$1,180	\$1,369	\$1,416	130
3-2451	\$944	\$1,180	\$1,369	\$1,416	130
3-2455	\$1,090	\$1,363	\$1,581	\$1,635	131
3-2456	\$1,520	\$1,900	\$2,204	\$2,280	131
3-2457	\$1,820	\$2,275	\$2,639	\$2,730	131
3-2461	\$944	\$1,180	\$1,369	\$1,416	189
3-2465	\$1,090	\$1,363	\$1,581	\$1,635	190
3-2471	\$944	\$1,180	\$1,369	\$1,416	189
3-2475	\$1,090	\$1,363	\$1,581	\$1,635	190
3-2476	\$1,520	\$1,900	\$2,204	\$2,280	189
3-2477	\$1,820	\$2,275	\$2,639	\$2,730	190
3-2481	\$944	\$1,180	\$1,369	\$1,416	242
3-2485	\$1,090	\$1,363	\$1,581	\$1,635	244
3-2486	\$1,520	\$1,900	\$2,204	\$2,280	243
3-2487	\$1,820	\$2,275	\$2,639	\$2,730	244
3-2491	\$944	\$1,180	\$1,369	\$1,416	243
3-2495	\$1,090	\$1,363	\$1,581	\$1,635	245
3-2496	\$1,520	\$1,900	\$2,204	\$2,280	243
3-2497	\$1,820	\$2,275	\$2,639	\$2,730	244
3-2541	\$1,163	\$1,454	\$1,687	\$1,745	258
3-2545	\$1,090	\$1,371	\$1,581	\$1,635	260
3-2546	\$1,836	\$2,295	\$2,663	\$2,754	259

PART	I	II	III	IV	PAGE
3-2547	\$2,136	\$3,223	\$3,844	\$4,035	260
3-2551	\$964	\$1,281	\$1,426	\$1,446	183
3-2555	\$1,090	\$1,363	\$1,581	\$1,635	184
3-2556	\$1,836	\$2,332	\$2,663	\$2,754	183
3-2557	\$2,936	\$3,771	\$4,258	\$4,404	183
3-2561	\$1,163	\$1,454	\$1,687	\$1,745	258
3-2565	\$1,090	\$1,369	\$1,581	\$1,635	260
3-2566	\$1,836	\$2,295	\$2,663	\$2,754	259
3-2567	\$2,136	\$3,223	\$3,844	\$4,025	259
3-2575	\$1,090	\$1,363	\$1,581	\$1,635	197
3-2576	\$1,836	\$2,295	\$2,663	\$2,754	197
3-2577	\$2,136	\$2,692	\$3,098	\$3,204	197
3-2915	\$1,090	\$1,363	\$1,581	\$1,635	279
3-2916	\$1,836	\$2,295	\$2,663	\$2,754	279
3-2917	\$2,136	\$2,692	\$3,098	\$3,204	279
3-2921	\$1,163	\$1,454	\$1,687	\$1,745	165
3-2925	\$1,090	\$1,366	\$1,581	\$1,635	167
3-2941	\$1,163	\$1,454	\$1,687	\$1,700	269
3-2945	\$1,090	\$1,363	\$1,581	\$1,635	270
3-2946	\$1,520	\$1,915	\$2,204	\$2,280	269
3-2947	\$1,820	\$2,409	\$2,838	\$2,950	269
3-2971	\$1,163	\$2,018	\$2,319	\$2,410	157
3-2975	\$1,070	\$1,337	\$1,551	\$1,604	158
3-2976	\$1,836	\$2,295	\$2,663	\$2,754	157
3-2977	\$2,136	\$2,670	\$3,098	\$3,204	157
3-2981	\$1,163	\$2,018	\$2,319	\$2,410	157
3-2985	\$1,090	\$1,363	\$1,581	\$1,635	158
3013-1	\$387	\$483	\$551	\$579	371
3014-1	\$387	\$483	\$551	\$579	371
3-3101	\$944	\$1,180	\$1,369	\$1,416	242
3-3105	\$1,090	\$1,363	\$1,581	\$1,635	244
3-3106	\$1,520	\$1,900	\$2,204	\$2,280	243
3-3107	\$1,820	\$2,275	\$2,639	\$2,730	244
3-3121	\$944	\$1,180	\$1,369	\$1,416	243
3-3125	\$1,090	\$1,363	\$1,581	\$1,635	245
3-3126	\$1,520	\$1,900	\$2,204	\$2,280	243
3-3127	\$1,820	\$2,275	\$2,639	\$2,730	244
3-3145	\$1,090	\$1,363	\$1,581	\$1,635	207
3-3146	\$1,836	\$2,295	\$2,663	\$2,754	207
3-3147	\$2,136	\$2,670	\$3,098	\$3,204	207
3-3231	\$1,163	\$1,454	\$1,687	\$1,730	235
3-3235	\$1,090	\$1,386	\$1,607	\$1,635	236

PART	I	II	III	IV	PAGE
3-3236	\$1,610	\$2,067	\$2,375	\$2,415	236
3-3237	\$2,136	\$2,670	\$3,098	\$3,204	236
3-3241	\$1,163	\$1,454	\$1,687	\$1,730	236
3-3245	\$1,090	\$1,386	\$1,607	\$1,635	236
3-3251	\$1,163	\$1,454	\$1,687	\$1,730	151
3-3255	\$1,090	\$1,386	\$1,607	\$1,635	152
3-3256	\$1,836	\$2,295	\$2,663	\$2,754	152
3-3257	\$2,136	\$2,670	\$3,098	\$3,204	152
3-3261	\$1,163	\$1,454	\$1,687	\$1,730	151
3-3271	\$944	\$1,320	\$1,648	\$1,730	177
3-3275	\$1,090	\$1,386	\$1,607	\$1,635	178
3-3276	\$1,836	\$2,295	\$2,663	\$2,754	178
3-3277	\$2,136	\$2,670	\$3,098	\$3,204	178
3-3281	\$944	\$1,320	\$1,648	\$1,730	178
3-3285	\$1,090	\$1,386	\$1,607	\$1,635	179
3-3286	\$1,836	\$2,295	\$2,663	\$2,754	178
3-3287	\$2,136	\$2,670	\$3,098	\$3,204	178
3-3291	\$1,163	\$1,454	\$1,687	\$1,730	229
3-3295	\$1,090	\$1,386	\$1,607	\$1,635	230
3-3296	\$1,836	\$2,295	\$2,663	\$2,754	230
3-3297	\$2,136	\$2,670	\$3,098	\$3,204	230
3-3301	\$1,163	\$1,454	\$1,687	\$1,730	230
3-3321	\$944	\$1,223	\$1,528	\$1,528	274
3-3325	\$1,090	\$1,363	\$1,581	\$1,635	274
3-3326	\$1,836	\$2,295	\$2,663	\$2,754	274
3-3327	\$2,136	\$2,670	\$3,098	\$3,204	274
3-3331	\$944	\$1,223	\$1,528	\$1,528	274
3-3335	\$1,090	\$1,363	\$1,581	\$1,635	275
3-3421	\$1,780	\$2,225	\$2,581	\$2,759	201
3-3425	\$1,790	\$2,238	\$2,596	\$2,775	202
3-3431	\$1,780	\$2,225	\$2,581	\$2,759	202
3-3435	\$1,790	\$2,238	\$2,596	\$2,775	202
3-9301	\$944	\$1,227	\$1,472	\$1,472	141
3-1003TR	\$786	\$983	\$1,140	\$1,179	146
3-1003TS	\$786	\$983	\$1,140	\$1,179	146
3-1004TR	\$639	\$799	\$927	\$959	146
3-1032BP	\$1,142	\$1,428	\$1,656	\$1,713	145
3-1034BP	\$863	\$1,079	\$1,252	\$1,295	145
3-1034TR	\$639	\$799	\$927	\$959	146
3-1203TR	\$786	\$983	\$1,140	\$1,179	218
3-1203TS	\$786	\$983	\$1,140	\$1,179	218
3-1204BP	\$863	\$1,079	\$1,252	\$1,295	218

PART	I	II	III	IV	PAGE
3-1204TR	\$639	\$799	\$927	\$959	218
3-1406L	\$1,520	\$1,900	\$2,204	\$2,280	166
3-1407L	\$1,820	\$2,275	\$2,639	\$2,730	166
3-1502BP	\$1,142	\$1,428	\$1,656	\$1,713	172
3-1503TR	\$786	\$983	\$1,140	\$1,179	172
3-1503TS	\$786	\$983	\$1,140	\$1,179	172
3-1504BP	\$863	\$1,079	\$1,252	\$1,295	171
3-1504TR	\$639	\$799	\$927	\$959	173
3-1603TR	\$786	\$983	\$1,140	\$1,179	226
3-1604TR	\$639	\$802	\$927	\$959	226
3-1623TR	\$786	\$983	\$1,140	\$1,179	225
3-1624BP	\$863	\$1,121	\$1,295	\$1,295	225
3-1624TR	\$639	\$802	\$927	\$959	226
3-163	\$302	\$378	\$438	\$453	125
3-163B	\$276	\$345	\$401	\$414	125
3-1663TR	\$786	\$983	\$1,140	\$1,179	253
3-1744TR	\$639	\$799	\$927	\$959	253
3-1763TR	\$786	\$983	\$1,140	\$1,179	286
3-1764TR	\$831	\$1,039	\$1,205	\$1,247	286
3-188H	\$405	\$520	\$624	\$624	116
3-192	\$1,077	\$1,347	\$1,562	\$1,616	122
3-196	\$767	\$980	\$1,175	\$1,175	122
3-202	\$260	\$335	\$400	\$400	253
3-2023TR	\$786	\$983	\$1,140	\$1,179	247
3-2023TS	\$786	\$983	\$1,140	\$1,179	263
3-2044BP	\$1,372	\$1,715	\$1,990	\$2,058	262
3-2044TS	\$831	\$1,039	\$1,205	\$1,247	263
3-2063TS	\$786	\$983	\$1,140	\$1,179	263
3-2064TS	\$831	\$1,039	\$1,205	\$1,247	263
3-226	\$736	\$944	\$1,135	\$1,135	122
3-227	\$288	\$371	\$445	\$445	173
3-227LH	\$288	\$371	\$445	\$445	173
3-230	\$253	\$324	\$390	\$390	147
3-230B	\$253	\$324	\$390	\$390	147
3-234	\$274	\$342	\$397	\$411	157
3-2403TR	\$786	\$983	\$1,140	\$1,179	135
3-2404BP	\$1,372	\$1,715	\$1,990	\$2,058	134
3-2404TR	\$831	\$1,039	\$1,205	\$1,247	135
3-241	\$253	\$324	\$390	\$390	147
3-2412BP	\$1,442	\$1,803	\$2,091	\$2,163	134
3-2413TR	\$786	\$983	\$1,140	\$1,179	135
3-2414BP	\$1,372	\$1,715	\$1,990	\$2,058	134

PART	I	II	III	IV	PAGE
3-2414TR	\$831	\$1,039	\$1,205	\$1,247	135
3-241B	\$253	\$324	\$390	\$390	147
3-245	\$253	\$324	\$390	\$390	219
3-2454BP	\$1,372	\$1,715	\$1,990	\$2,058	134
3-248	\$427	\$545	\$654	\$654	112
3-2484BP	\$1,372	\$1,715	\$1,990	\$2,058	246
3-2484TR	\$979	\$1,224	\$1,420	\$1,469	247
3-2494BP	\$1,372	\$1,715	\$1,990	\$2,058	247
3-2544BP	\$1,372	\$1,856	\$2,134	\$2,225	262
3-2544TS	\$831	\$1,067	\$1,205	\$1,247	263
3-255	\$288	\$371	\$445	\$465	173
3-2552BP	\$1,687	\$2,278	\$2,534	\$2,650	185
3-2554BP	\$1,372	\$1,733	\$1,990	\$2,058	185
3-2554TR	\$831	\$1,067	\$1,190	\$1,247	185
3-2564BP	\$1,372	\$1,856	\$2,134	\$2,225	262
3-2573TS	\$786	\$1,023	\$1,175	\$1,200	198
3-2574BP	\$1,372	\$1,802	\$2,070	\$2,175	198
3-2574TS	\$831	\$1,081	\$1,242	\$1,247	198
3-279	\$309	\$394	\$473	\$473	226
3-279L	\$309	\$394	\$473	\$473	226
3-289	\$475	\$593	\$704	\$712	253
3-2913TR	\$913	\$1,142	\$1,324	\$1,370	280
3-2914TR	\$831	\$1,081	\$1,242	\$1,247	280
3-2923TR	\$913	\$1,216	\$1,396	\$1,450	172
3-2924TR	\$979	\$1,280	\$1,455	\$1,469	173
3-2943TR	\$913	\$1,142	\$1,324	\$1,370	270
3-2944TR	\$979	\$1,224	\$1,420	\$1,469	271
3-2973TR	\$913	\$1,206	\$1,386	\$1,450	159
3-2974BP	\$1,279	\$1,721	\$1,988	\$2,050	159
3-2974TR	\$979	\$1,273	\$1,440	\$1,469	159
3-2983TR	\$913	\$1,206	\$1,386	\$1,450	159
3-2984TR	\$979	\$1,273	\$1,440	\$1,469	159
3-3102BP	\$1,442	\$1,803	\$2,091	\$2,163	247
3-3103TR	\$786	\$983	\$1,140	\$1,179	247
3-3104BP	\$1,372	\$1,715	\$1,990	\$2,058	246
3-3124BP	\$1,372	\$1,715	\$1,990	\$2,058	247
3-3143TS	\$913	\$1,206	\$1,386	\$1,386	208
3-3144BP	\$1,279	\$1,721	\$1,988	\$2,050	208
3-3144TS	\$979	\$1,273	\$1,440	\$1,469	208
3-3153TS	\$913	\$1,206	\$1,386	\$1,386	208
3-3154TS	\$979	\$1,273	\$1,440	\$1,469	209
3-322	\$296	\$370	\$441	\$444	286

PART	I	II	III	IV	PAGE
3-323	\$296	\$370	\$441	\$444	286
3-3233TR	\$913	\$1,278	\$1,473	\$1,473	237
3-3234TR	\$979	\$1,224	\$1,432	\$1,469	237
3-3243TR	\$913	\$1,278	\$1,473	\$1,473	237
3-3244TR	\$979	\$1,224	\$1,432	\$1,469	238
3-3253TR	\$913	\$1,278	\$1,473	\$1,473	153
3-3254TR	\$979	\$1,224	\$1,432	\$1,469	153
3-3263TR	\$913	\$1,278	\$1,473	\$1,473	153
3-3264TR	\$979	\$1,224	\$1,432	\$1,469	153
3-3273TR	\$913	\$1,278	\$1,473	\$1,473	180
3-3274TR	\$979	\$1,224	\$1,432	\$1,469	180
3-328	\$296	\$370	\$429	\$444	261
3-3283TR	\$913	\$1,278	\$1,473	\$1,473	180
3-3284TR	\$979	\$1,224	\$1,432	\$1,469	180
3-3293TR	\$913	\$1,278	\$1,473	\$1,473	231
3-3294TR	\$979	\$1,224	\$1,432	\$1,469	231
3-3303TR	\$913	\$1,278	\$1,473	\$1,473	231
3-3304TR	\$979	\$1,224	\$1,432	\$1,469	232
3-3323TR	\$913	\$1,142	\$1,324	\$1,370	275
3-3324TR	\$831	\$1,039	\$1,205	\$1,247	276
3-3333TR	\$913	\$1,142	\$1,324	\$1,370	276
3-3334TR	\$831	\$1,039	\$1,205	\$1,247	276
3-3423TR	\$1,013	\$1,266	\$1,469	\$1,570	204
3-3424TR	\$1,213	\$1,516	\$1,758	\$1,880	204
3-343	\$253	\$324	\$390	\$390	125
3-3433TR	\$1,013	\$1,266	\$1,469	\$1,570	204
3-3434TR	\$1,213	\$1,516	\$1,758	\$1,880	204
3-368	\$286	\$357	\$415	\$429	263
3-373	\$286	\$357	\$415	\$429	135
3-374	\$286	\$357	\$415	\$429	135
3-378	\$286	\$357	\$415	\$429	136
3-379	\$286	\$357	\$415	\$429	135
3-383	\$296	\$370	\$429	\$444	132
3-407	\$296	\$370	\$429	\$444	246
3-419	\$296	\$370	\$429	\$444	245
3-427	\$366	\$457	\$530	\$548	184
3-447	\$464	\$580	\$672	\$695	219
3-549	\$287	\$359	\$416	\$431	248
3-561	\$318	\$397	\$460	\$476	280
3-570	\$355	\$443	\$514	\$532	173
3-573	\$275	\$344	\$399	\$413	159
3-575	\$275	\$344	\$399	\$413	159

PART	I	II	III	IV	PAGE
3-577	\$286	\$357	\$415	\$429	264
3-580	\$329	\$411	\$476	\$493	209
3-581	\$329	\$411	\$476	\$493	209
3-583	\$411	\$514	\$596	\$617	207
3-593	\$277	\$347	\$421	\$421	185
3-594	\$275	\$344	\$399	\$413	198
3-595	\$253	\$324	\$390	\$390	219
3-608	\$275	\$344	\$399	\$413	248
3-609	\$296	\$370	\$429	\$444	263
3-614	\$366	\$457	\$530	\$548	335
3-615	\$366	\$457	\$530	\$548	245
3-641	\$436	\$545	\$633	\$654	236
3-642	\$436	\$545	\$633	\$654	151
3-643	\$436	\$545	\$633	\$654	179
3-644	\$302	\$378	\$465	\$465	238
3-645	\$329	\$411	\$476	\$493	238
3-646	\$290	\$373	\$465	\$465	153
3-647	\$290	\$373	\$465	\$465	153
3-648	\$290	\$373	\$465	\$465	180
3-649	\$290	\$373	\$465	\$465	180
3-667	\$378	\$472	\$547	\$566	285
3-668	\$296	\$370	\$429	\$444	191
3-669	\$296	\$370	\$429	\$444	132
3-671	\$322	\$444	\$529	\$529	329
3-672	\$322	\$444	\$529	\$529	329
3-677	\$484	\$605	\$702	\$751	203
3-692	\$290	\$373	\$465	\$465	232
3-693	\$290	\$373	\$465	\$465	232
3-695	\$351	\$439	\$509	\$527	230
3-721	\$257	\$329	\$412	\$412	276
3-722	\$257	\$329	\$412	\$412	276
3-724	\$361	\$451	\$524	\$542	275
3-727	\$257	\$329	\$412	\$412	271
3-729	\$361	\$451	\$524	\$542	270
3-803TR	\$786	\$983	\$1,140	\$1,179	111
3-804TR	\$639	\$799	\$927	\$959	112
3-855	\$1,090	\$1,363	\$1,581	\$1,635	252
3-856c	\$1,520	\$1,900	\$2,204	\$2,280	251
3-857c	\$1,820	\$2,275	\$2,639	\$2,730	251
3-896	\$1,520	\$1,900	\$2,204	\$2,280	120
3-897	\$1,820	\$2,275	\$2,639	\$2,730	121
3-911	\$944	\$1,180	\$1,369	\$1,416	120

PART	I	II	III	IV	PAGE
3-912BP	\$1,142	\$1,428	\$1,656	\$1,713	124
3-913TR	\$786	\$983	\$1,140	\$1,179	124
3-913TS	\$786	\$983	\$1,140	\$1,179	124
3-914BP	\$863	\$1,079	\$1,252	\$1,295	123
3-914TR	\$639	\$799	\$927	\$959	125
3-915	\$1,090	\$1,363	\$1,581	\$1,635	121
3-916	\$1,520	\$1,900	\$2,204	\$2,280	120
3-917	\$1,820	\$2,275	\$2,639	\$2,730	120
3-921	\$944	\$1,180	\$1,369	\$1,416	120
3-922BP	\$1,142	\$1,428	\$1,656	\$1,713	124
3-923TR	\$786	\$983	\$1,140	\$1,179	124
3-923TS	\$786	\$983	\$1,140	\$1,179	125
3-924BP	\$863	\$1,079	\$1,252	\$1,295	124
3-924TR	\$639	\$799	\$927	\$959	125
3-925	\$1,090	\$1,363	\$1,581	\$1,635	121
3-926	\$1,520	\$1,900	\$2,204	\$2,280	120
3-927	\$1,820	\$2,275	\$2,639	\$2,730	121
3-93OIL	\$944	\$1,227	\$1,472	\$1,472	140
3-936	\$1,520	\$1,900	\$2,204	\$2,280	142
3-937	\$1,820	\$2,275	\$2,639	\$2,730	142
3-944	\$944	\$1,227	\$1,472	\$1,472	141
3-944L	\$944	\$1,227	\$1,472	\$1,550	140
3-947	\$944	\$1,189	\$1,369	\$1,416	141
3-984BP	\$863	\$1,121	\$1,297	\$1,297	116
3-985	\$1,090	\$1,363	\$1,581	\$1,635	115
3-991	\$944	\$1,180	\$1,369	\$1,416	165
3-991L	\$944	\$1,180	\$1,369	\$1,416	165
3-992BP	\$1,142	\$1,428	\$1,656	\$1,713	172
3-993TR	\$786	\$983	\$1,140	\$1,179	172
3-993TS	\$786	\$983	\$1,140	\$1,179	172
3-994BP	\$863	\$1,079	\$1,252	\$1,295	171
3-994LBP	\$849	\$1,061	\$1,230	\$1,273	171
3-994LTR	\$639	\$799	\$927	\$959	173
3-994TR	\$639	\$799	\$927	\$959	173
3-995	\$1,090	\$1,363	\$1,581	\$1,635	167
3-995L	\$1,090	\$1,363	\$1,581	\$1,635	167
3-996	\$1,520	\$1,900	\$2,204	\$2,280	166
3-996L	\$1,520	\$1,900	\$2,204	\$2,280	166
3-997	\$1,820	\$2,275	\$2,639	\$2,730	166
3-997L	\$1,820	\$2,275	\$2,639	\$2,730	166
30-113	\$205	\$257	\$298	\$308	100
30-114	\$157	\$197	\$228	\$236	99

PART	I	II	III	IV	PAGE
30-115	\$184	\$229	\$266	\$275	100
30-130	\$384	\$480	\$557	\$596	205
30-132	\$484	\$580	\$657	\$696	205
301-2	\$415	\$570	\$647	\$679	371
100	\$98	\$123	\$143	\$147	37
101	\$120	\$157	\$174	\$180	129
103	\$51	\$63	\$73	\$76	98
106	\$938	\$1,173	\$1,361	\$1,407	37
107	\$878	\$1,098	\$1,274	\$1,317	67
107C	\$758	\$948	\$1,100	\$1,137	67
107H	\$758	\$948	\$1,100	\$1,137	67
108	\$1,120	\$1,400	\$1,624	\$1,680	29
111	\$283	\$353	\$410	\$424	98
112	\$109	\$153	\$181	\$190	368
113	\$66	\$106	\$129	\$135	368
120	\$250	\$290	\$339	\$356	368
121	\$217	\$255	\$277	\$291	368
122	\$194	\$221	\$255	\$268	368
124	\$301	\$377	\$437	\$452	100
125	\$273	\$341	\$396	\$409	99
127	\$352	\$440	\$511	\$528	30
200	\$78	\$98	\$117	\$117	313
201	\$85	\$107	\$125	\$128	313
202	\$183	\$229	\$266	\$275	313
203	\$105	\$131	\$152	\$157	313
205	\$144	\$180	\$209	\$216	313
206	\$56	\$70	\$81	\$84	314
207	\$56	\$70	\$81	\$84	314
208	\$273	\$341	\$396	\$409	313
211	\$523	\$653	\$758	\$784	312
212	\$385	\$481	\$558	\$578	312
214	\$1,039	\$1,299	\$1,507	\$1,559	312
215	\$2,541	\$3,177	\$3,685	\$3,812	315
217	\$218	\$273	\$317	\$327	332
230	\$55	\$72	\$86	\$90	369
231	\$110	\$141	\$182	\$191	369
236	\$69	\$81	\$94	\$99	369
238	\$94	\$110	\$128	\$134	369
255	\$305	\$369	\$415	\$436	370
257	\$666	\$898	\$1,079	\$1,133	369
265	\$84	\$88	\$110	\$116	370
266	\$84	\$104	\$124	\$130	370

PART	I	II	III	IV	PAGE
267	\$87	\$116	\$141	\$148	370
270	\$116	\$141	\$155	\$163	370
272	\$141	\$181	\$219	\$230	370
273	\$187	\$233	\$275	\$289	370
274	\$215	\$265	\$311	\$327	371
275	\$124	\$155	\$208	\$218	371
276	\$208	\$265	\$296	\$311	371
280	\$260	\$325	\$377	\$390	318
281	\$259	\$323	\$375	\$388	318
283	\$363	\$495	\$612	\$612	318
284	\$217	\$272	\$315	\$326	328
285	\$116	\$145	\$168	\$174	328
287	\$176	\$220	\$255	\$264	329
288	\$221	\$276	\$320	\$331	329
291	\$104	\$131	\$158	\$165	329
292	\$630	\$788	\$914	\$945	324
294	\$853	\$1,066	\$1,236	\$1,279	324
295	\$853	\$1,066	\$1,236	\$1,279	324
296	\$192	\$240	\$279	\$288	329
297	\$192	\$240	\$279	\$288	329
314	\$66	\$82	\$95	\$100	371
321	\$143	\$197	\$218	\$229	372
324	\$280	\$374	\$429	\$450	372
325	\$195	\$265	\$303	\$318	372
326	\$269	\$351	\$404	\$424	372
327	\$114	\$135	\$150	\$158	373
328	\$130	\$163	\$181	\$190	373
330	\$177	\$249	\$285	\$299	372
403	\$135	\$172	\$206	\$216	374
412	\$130	\$163	\$175	\$184	374
416	\$171	\$211	\$253	\$266	374
417	\$171	\$226	\$255	\$268	375
432	\$75	\$88	\$105	\$110	375
435	\$62	\$82	\$94	\$99	375
436	\$66	\$94	\$99	\$104	375
441	\$44	\$54	\$62	\$65	375
482	\$190	\$241	\$279	\$293	375
493	\$361	\$542	\$602	\$632	376
495	\$184	\$239	\$306	\$321	376
499	\$157	\$226	\$240	\$252	372
500	\$172	\$215	\$250	\$258	363
808	\$797	\$997	\$1,156	\$1,196	96

PART	I	II	III	IV	PAGE
850	\$1,214	\$1,518	\$1,761	\$1,821	251
890	\$1,198	\$1,498	\$1,738	\$1,797	119
910	\$1,198	\$1,498	\$1,738	\$1,797	119
920	\$1,198	\$1,498	\$1,738	\$1,797	119
928	\$1,359	\$1,699	\$1,971	\$2,039	29
929	\$1,907	\$2,446	\$2,936	\$3,025	125
930	\$1,357	\$1,697	\$1,968	\$2,036	139
932	\$1,038	\$1,380	\$1,660	\$1,710	140
933	\$1,822	\$2,340	\$2,804	\$2,945	143
934	\$1,736	\$2,227	\$2,674	\$2,808	143
938	\$1,359	\$1,699	\$1,971	\$2,039	29
940	\$1,393	\$1,717	\$1,991	\$2,060	67
941	\$1,784	\$2,230	\$2,587	\$2,676	67
942	\$1,402	\$1,753	\$2,033	\$2,103	25
943	\$1,787	\$2,234	\$2,592	\$2,681	25
945	\$1,551	\$1,939	\$2,249	\$2,327	26
946	\$1,787	\$2,234	\$2,592	\$2,681	27
972	\$1,402	\$1,753	\$2,033	\$2,103	25
973	\$1,787	\$2,234	\$2,592	\$2,681	25
980	\$1,357	\$1,697	\$1,968	\$2,036	115
989	\$2,040	\$2,620	\$3,147	\$3,240	116
990	\$1,357	\$1,697	\$1,968	\$2,036	163
1000	\$1,357	\$1,697	\$1,968	\$2,036	139
1008	\$1,404	\$1,755	\$2,036	\$2,106	29
1013	\$1,822	\$2,340	\$2,804	\$2,945	143
1014	\$1,736	\$2,227	\$2,674	\$2,808	143
1020	\$1,357	\$1,697	\$1,968	\$2,036	115
1030	\$1,357	\$1,697	\$1,968	\$2,036	139
1033	\$1,168	\$1,489	\$1,745	\$1,752	140
1038	\$1,359	\$1,699	\$1,971	\$2,039	28
1090	\$1,773	\$2,217	\$2,571	\$2,660	111
1200	\$1,214	\$1,518	\$1,761	\$1,821	213
1203	\$1,168	\$1,460	\$1,745	\$1,752	213
1203-1	\$1,268	\$1,585	\$1,839	\$1,902	214
1208	\$1,077	\$1,347	\$1,562	\$1,616	94
1220	\$1,214	\$1,518	\$1,761	\$1,821	213
1230	\$1,257	\$1,680	\$1,849	\$1,905	213
1233	\$1,268	\$1,624	\$1,863	\$1,902	214
1400	\$1,357	\$1,697	\$1,968	\$2,036	163
1500	\$1,357	\$1,697	\$1,968	\$2,036	163
1503	\$1,168	\$1,460	\$1,694	\$1,752	164
1503-1	\$1,168	\$1,489	\$1,745	\$1,752	164

PART	I	II	III	IV	PAGE
1508	\$1,408	\$1,760	\$2,042	\$2,112	165
1600	\$1,214	\$1,566	\$1,779	\$1,821	223
1620	\$1,214	\$1,566	\$1,779	\$1,821	223
1628	\$1,077	\$1,347	\$1,562	\$1,616	96
1623-1	\$1,168	\$1,489	\$1,745	\$1,752	223
1668	\$1,087	\$1,359	\$1,577	\$1,631	96
1740	\$1,571	\$1,964	\$2,278	\$2,357	251
1760	\$1,357	\$1,697	\$1,968	\$2,036	283
1770	\$1,357	\$1,697	\$1,968	\$2,036	283
2007	\$1,210	\$1,513	\$1,755	\$1,815	37
2008	\$1,235	\$1,544	\$1,791	\$1,853	36
2021	\$190	\$238	\$276	\$285	313
2040	\$1,500	\$1,875	\$2,175	\$2,250	257
2043	\$1,268	\$1,625	\$1,865	\$1,902	258
2049	\$1,798	\$2,247	\$2,607	\$2,697	264
2060	\$1,500	\$1,875	\$2,175	\$2,250	257
2141	\$604	\$755	\$885	\$906	312
2142	\$604	\$755	\$885	\$906	312
2143	\$677	\$847	\$1,002	\$1,016	312
2144	\$677	\$847	\$1,002	\$1,016	312
2152	\$1,190	\$1,487	\$1,770	\$1,784	315
2153	\$1,190	\$1,487	\$1,770	\$1,784	315
2154	\$746	\$932	\$1,082	\$1,119	312
2155	\$310	\$387	\$449	\$465	312
2156	\$310	\$387	\$449	\$465	312
2157	\$777	\$971	\$1,126	\$1,165	312
2158	\$777	\$971	\$1,126	\$1,165	312
2159	\$777	\$971	\$1,126	\$1,165	312
2161	\$853	\$1,066	\$1,236	\$1,279	315
2162	\$1,099	\$1,374	\$1,609	\$1,649	315
2165	\$1,299	\$1,624	\$1,884	\$1,949	315
2168	\$1,299	\$1,624	\$1,884	\$1,949	315
2170	\$314	\$393	\$456	\$471	332
2171	\$314	\$393	\$456	\$471	332
2173	\$314	\$393	\$456	\$471	332
2174	\$314	\$393	\$456	\$471	332
2178	\$314	\$393	\$456	\$471	332
2201	\$262	\$333	\$395	\$400	252
2400	\$1,357	\$1,697	\$1,968	\$2,036	129
2403	\$1,168	\$1,460	\$1,694	\$1,752	241
2410	\$1,357	\$1,697	\$1,968	\$2,036	129
2413	\$1,168	\$1,460	\$1,694	\$1,752	242

PART	I	II	III	IV	PAGE
2419	\$1,798	\$2,247	\$2,607	\$2,697	136
2420	\$1,357	\$1,697	\$1,968	\$2,036	129
2430	\$1,357	\$1,697	\$1,968	\$2,036	129
2433	\$1,168	\$1,460	\$1,694	\$1,752	129
2440	\$1,357	\$1,697	\$1,968	\$2,036	129
2450	\$1,357	\$1,697	\$1,968	\$2,036	129
2460	\$1,357	\$1,697	\$1,968	\$2,036	189
2470	\$1,357	\$1,697	\$1,968	\$2,036	189
2473	\$1,168	\$1,460	\$1,694	\$1,752	189
2480	\$1,286	\$1,608	\$1,865	\$1,929	241
2489	\$1,725	\$2,156	\$2,501	\$2,587	248
2490	\$1,286	\$1,608	\$1,865	\$1,929	241
2493	\$1,168	\$1,460	\$1,694	\$1,752	242
2540	\$1,500	\$1,875	\$2,175	\$2,250	257
2550	\$1,500	\$1,875	\$2,175	\$2,250	183
2560	\$1,357	\$1,697	\$1,968	\$2,036	257
2563	\$1,168	\$1,460	\$1,694	\$1,752	258
2570	\$1,500	\$1,875	\$2,175	\$2,250	197
2910	\$1,500	\$1,875	\$2,175	\$2,250	279
2920	\$1,436	\$2,099	\$2,391	\$2,510	164
2930	\$1,286	\$1,608	\$1,865	\$1,929	164
2940	\$1,357	\$1,697	\$1,968	\$2,036	269
2950	\$1,436	\$2,099	\$2,391	\$2,511	164
2960	\$1,321	\$1,951	\$2,249	\$2,362	164
2970	\$1,357	\$1,732	\$1,968	\$2,036	157
2980	\$1,357	\$1,732	\$1,968	\$2,036	157
2990	\$1,357	\$1,697	\$1,968	\$2,036	257
3013	\$279	\$347	\$399	\$419	371
3014	\$257	\$322	\$374	\$393	371
3016	\$455	\$638	\$720	\$756	371
3100	\$1,286	\$1,608	\$1,865	\$1,929	241
3103	\$1,168	\$1,460	\$1,694	\$1,752	242
3110	\$1,286	\$1,608	\$1,865	\$1,929	241
3120	\$1,286	\$1,608	\$1,865	\$1,929	241
3130	\$1,286	\$1,608	\$1,865	\$1,929	241
3140	\$1,357	\$1,767	\$2,060	\$2,120	207
3150	\$1,357	\$1,767	\$2,060	\$2,120	207
3211	\$143	\$197	\$218	\$229	372
3212	\$227	\$273	\$313	\$329	372
3213	\$227	\$273	\$313	\$329	372
3230	\$1,500	\$1,875	\$2,175	\$2,250	235
3233	\$1,168	\$1,489	\$1,745	\$1,752	235

PART	I	II	III	IV	PAGE
3240	\$1,500	\$1,875	\$2,175	\$2,250	235
3250	\$1,500	\$1,875	\$2,175	\$2,250	151
3251	\$65				372
3260	\$1,500	\$1,875	\$2,175	\$2,250	151
3270	\$1,500	\$1,875	\$2,175	\$2,250	177
3273	\$1,168	\$1,489	\$1,745	\$1,752	177
3280	\$1,500	\$1,875	\$2,175	\$2,250	177
3290	\$1,500	\$1,875	\$2,175	\$2,250	229
3293	\$1,168	\$1,489	\$1,745	\$1,752	229
3300	\$1,500	\$1,875	\$2,175	\$2,250	229
3301	\$195	\$265	\$303	\$318	372
3302	\$239	\$288	\$328	\$344	372
3303	\$239	\$288	\$328	\$344	372
3320	\$1,357	\$1,697	\$1,968	\$2,036	273
3330	\$1,357	\$1,697	\$1,968	\$2,036	273
3360	\$1,500	\$1,875	\$2,175	\$2,250	229
3370	\$1,500	\$1,875	\$2,175	\$2,250	229
3380	\$1,357	\$1,697	\$1,968	\$2,036	273
3390	\$1,357	\$1,697	\$1,968	\$2,036	274
3400	\$1,357	\$1,697	\$1,968	\$2,036	273
3410	\$1,357	\$1,697	\$1,968	\$2,036	273
3420	\$1,850	\$2,313	\$2,683	\$2,868	201
3423	\$1,372	\$1,715	\$1,989	\$2,058	201
3429	\$2,066	\$2,583	\$2,996	\$3,202	205
3430	\$1,850	\$2,313	\$2,683	\$2,868	201
3439	\$2,066	\$2,583	\$2,996	\$3,202	205
5080	\$210	\$263	\$305	\$315	359
5081	\$235	\$294	\$341	\$353	359
5082	\$230	\$292	\$334	\$345	359
5083	\$275	\$344	\$399	\$413	359
5085	\$405	\$506	\$587	\$607	359
8081	\$1,222	\$1,528	\$1,772	\$1,833	67
9203	\$1,268	\$1,654	\$1,901	\$1,902	119
9208	\$1,408	\$1,760	\$2,042	\$2,112	119
9281	\$1,087	\$1,359	\$1,577	\$1,631	91
9451	\$1,698	\$2,123	\$2,463	\$2,547	27
9455	\$1,782	\$2,228	\$2,584	\$2,673	26
9456	\$2,340	\$2,925	\$3,393	\$3,510	27
9457	\$1,745	\$2,182	\$2,531	\$2,618	26
9458	\$2,445	\$3,057	\$3,546	\$3,668	27
9459	\$2,503	\$3,129	\$3,630	\$3,755	27
9460	\$2,503	\$3,129	\$3,630	\$3,755	28

PART	I	II	III	IV	PAGE
9461	\$1,578	\$1,973	\$2,289	\$2,367	26
9462	\$2,074	\$2,593	\$3,008	\$3,111	27
9463	\$2,000	\$2,500	\$2,900	\$3,000	26
9464	\$2,000	\$2,500	\$2,900	\$3,000	26
9482	\$1,485	\$1,857	\$2,154	\$2,228	67
9901	\$1,581	\$1,977	\$2,293	\$2,372	34
9911	\$1,913	\$2,392	\$2,815	\$2,870	34
2043-1	\$1,168	\$1,460	\$1,694	\$1,752	258
RP51082	\$33				99
9451-1	\$2,240	\$2,800	\$3,248	\$3,360	28
9452-1	\$2,240	\$2,800	\$3,248	\$3,360	28
9453-1	\$2,240	\$2,800	\$3,248	\$3,360	27
10-81	\$517	\$646	\$750	\$775	361
10-89	\$275	\$344	\$399	\$413	361
106C	\$680	\$850	\$986	\$1,020	37
106H	\$845	\$1,057	\$1,226	\$1,268	37
108C	\$689	\$862	\$1,000	\$1,034	30
108H	\$861	\$1,077	\$1,249	\$1,292	29
1000B	\$1,786	\$2,233	\$2,590	\$2,679	139
1030B	\$2,143	\$2,679	\$3,108	\$3,215	139
15-01	\$348	\$435	\$505	\$522	117
15-02	\$368	\$460	\$533	\$551	117
15-09	\$257	\$321	\$372	\$385	116
15-13	\$241	\$302	\$350	\$362	117
15-27	\$368	\$460	\$533	\$551	117
15-28	\$368	\$460	\$533	\$551	117
111-2961	\$939	\$1,172	\$1,586	\$1,665	369
111-2962	\$939	\$1,172	\$1,586	\$1,665	369
112A	\$130	\$164	\$199	\$209	368
125-16	\$6				99
125-8	\$67				22
125-9	\$6				22
1020-2400	\$197	\$246	\$309	\$325	358
1020-3942	\$734	\$917	\$1,064	\$1,101	359
1030-5103	\$1,503	\$1,879	\$2,180	\$2,255	25
1030-5173	\$1,712	\$2,140	\$2,483	\$2,568	25
1030-5223	\$1,503	\$1,879	\$2,180	\$2,255	28
1030-5233	\$1,503	\$1,879	\$2,180	\$2,255	28
1030-5462	\$1,838	\$2,298	\$2,666	\$2,757	26
1030-5463	\$1,838	\$2,298	\$2,666	\$2,757	25
1030-5503	\$1,591	\$1,989	\$2,307	\$2,387	30
1030-5603	\$1,134	\$1,418	\$1,645	\$1,701	29

PART	I	II	III	IV	PAGE
1030-5613	\$883	\$1,104	\$1,281	\$1,325	29
1030-5623	\$750	\$938	\$1,088	\$1,125	30
1030-5711	\$185	\$232	\$269	\$278	30
1030-5721	\$389	\$487	\$565	\$584	30
1030-7173	\$2,165	\$2,707	\$3,140	\$3,356	25
1200-1230	\$272	\$340	\$394	\$408	219
1200-1250	\$323	\$404	\$469	\$485	219
1200-1400	\$235	\$293	\$340	\$352	219
1200-1500	\$352	\$440	\$511	\$528	220
1200-1510	\$251	\$314	\$364	\$377	220
1200-1660	\$160	\$199	\$231	\$239	219
1200-2400	\$197	\$246	\$309	\$325	358
1200-3942	\$734	\$917	\$1,064	\$1,101	359
1200-4273	\$2,171	\$2,713	\$3,147	\$3,256	216
1200-4283	\$2,071	\$2,589	\$3,003	\$3,107	216
1200-5103	\$1,643	\$2,054	\$2,383	\$2,465	55
1200-5223	\$1,643	\$2,054	\$2,383	\$2,465	55
1200-5503	\$1,591	\$1,989	\$2,307	\$2,387	55
1200-5603	\$1,122	\$1,403	\$1,627	\$1,683	55
1200-5613	\$883	\$1,104	\$1,281	\$1,325	55
1200-5623	\$735	\$919	\$1,066	\$1,103	55
1200C	\$1,357	\$1,697	\$1,968	\$2,036	213
1220C	\$1,357	\$1,697	\$1,968	\$2,036	213
122LS	\$207	\$229	\$265	\$278	368
1230C	\$1,381	\$1,752	\$1,968	\$2,036	213
1400-4261	\$2,862	\$3,578	\$4,150	\$4,293	170
1400-4262	\$3,128	\$3,910	\$4,535	\$4,691	169
1400-4263	\$3,128	\$3,910	\$4,535	\$4,691	169
1400-4272	\$2,402	\$3,002	\$3,718	\$3,830	168
1400-4273	\$2,402	\$3,002	\$3,718	\$3,830	167
1400-4282	\$2,162	\$2,754	\$3,497	\$3,600	168
1400-4283	\$2,162	\$2,754	\$3,497	\$3,600	168
1400-5113	\$1,536	\$1,920	\$2,228	\$2,304	33
1400-5143	\$1,536	\$1,920	\$2,228	\$2,304	33
1400-5402	\$1,878	\$2,348	\$2,724	\$2,817	35
1400-5403	\$1,878	\$2,348	\$2,724	\$2,817	35
1400-5412	\$2,394	\$3,178	\$3,711	\$3,897	36
1400-5413	\$2,454	\$3,178	\$3,711	\$3,897	36
1400-5462	\$2,042	\$2,553	\$2,961	\$3,063	35
1400-5463	\$2,042	\$2,553	\$2,961	\$3,063	35
1400L	\$1,357	\$1,697	\$1,968	\$2,036	163
1500-4262	\$3,128	\$3,910	\$4,535	\$4,691	169

PART	I	II	III	IV	PAGE
1500-4263	\$3,128	\$3,910	\$4,535	\$4,691	168
1500-4272	\$2,402	\$3,002	\$3,718	\$3,830	167
1500-4273	\$2,402	\$3,002	\$3,718	\$3,830	167
1500-4282	\$2,162	\$2,754	\$3,497	\$3,600	168
1500-4283	\$2,162	\$2,754	\$3,497	\$3,600	168
1500-5103	\$1,536	\$1,920	\$2,228	\$2,304	33
1500-5113	\$1,536	\$1,920	\$2,228	\$2,304	33
1500-5123	\$1,536	\$1,920	\$2,228	\$2,304	33
1500-5143	\$1,536	\$1,920	\$2,228	\$2,304	33
1500-5173	\$1,788	\$2,235	\$2,593	\$2,682	33
1500-5203	\$1,536	\$1,920	\$2,228	\$2,304	36
1500-5223	\$1,536	\$1,920	\$2,228	\$2,304	36
1500-5233	\$1,235	\$1,544	\$1,791	\$1,853	36
1500-5402	\$1,878	\$2,348	\$2,724	\$2,817	35
1500-5403	\$1,878	\$2,348	\$2,724	\$2,817	34
1500-5412	\$2,454	\$3,178	\$3,711	\$3,820	36
1500-5413	\$2,454	\$3,178	\$3,711	\$3,820	35
1500-5462	\$2,042	\$2,553	\$2,961	\$3,063	35
1500-5463	\$2,042	\$2,553	\$2,961	\$3,063	34
1500-5721	\$398	\$498	\$578	\$597	37
1500-5811	\$391	\$489	\$567	\$587	37
1500-7173	\$2,165	\$2,707	\$3,140	\$3,356	34
1600-1200	\$230	\$288	\$334	\$345	226
1600-1230	\$260	\$325	\$377	\$390	226
1600-1250	\$300	\$375	\$435	\$450	226
1600-1500	\$300	\$375	\$435	\$450	227
1600-1660	\$150	\$188	\$218	\$225	227
1600-2400	\$318	\$430	\$482	\$490	358
1600-3942	\$847	\$1,059	\$1,229	\$1,271	359
1600-4272	\$2,081	\$2,602	\$3,082	\$3,122	224
1600-4282	\$2,081	\$2,602	\$3,018	\$3,122	224
1620-4273	\$2,081	\$2,602	\$3,082	\$3,122	223
1620-4283	\$2,071	\$2,589	\$3,003	\$3,107	224
1760-4272	\$2,081	\$2,602	\$3,082	\$3,122	284
1760-4282	\$2,081	\$2,602	\$3,018	\$3,122	285
1770-4283	\$2,081	\$2,602	\$3,018	\$3,122	284
22-01	\$382	\$477	\$554	\$573	112
22-02	\$399	\$499	\$579	\$599	112
22-09	\$264	\$330	\$383	\$396	112
22-13	\$241	\$302	\$350	\$362	112
22-27	\$399	\$499	\$579	\$599	112
22-28	\$399	\$499	\$579	\$599	112

PART	I	II	III	IV	PAGE
20-131	\$289	\$369	\$421	\$434	279
20-146	\$329	\$411	\$476	\$493	347
20-258	\$381	\$488	\$581	\$581	197
20-289	\$233	\$297	\$361	\$379	174
20-373	\$216	\$270	\$313	\$324	22
RP20-374	\$216	\$270	\$313	\$324	40
20-405	\$216	\$270	\$313	\$324	56
20-406	\$90	\$113	\$191	\$200	362
20-511	\$247	\$308	\$358	\$370	346
20-512	\$247	\$308	\$358	\$370	347
20-513	\$247	\$308	\$358	\$370	347
20-514	\$247	\$308	\$358	\$370	347
200-1001	\$149	\$186	\$215	\$223	313
200-2001	\$395	\$494	\$573	\$592	313
200-7102	\$104	\$134	\$151	\$156	316
200-7104	\$104	\$134	\$151	\$156	316
200-7106	\$104	\$134	\$151	\$156	316
200-7108	\$104	\$134	\$151	\$156	316
200-7110	\$104	\$134	\$151	\$156	316
200-7112	\$149	\$186	\$215	\$223	316
200-7118	\$196	\$245	\$285	\$294	316
200-7124	\$197	\$246	\$285	\$295	316
200-7130	\$197	\$246	\$285	\$295	316
201-1	\$341	\$426	\$494	\$511	313
202-1	\$359	\$449	\$520	\$538	313
201-2	\$375	\$469	\$544	\$563	313
201-1001	\$526	\$657	\$762	\$789	313
206-1	\$56	\$70	\$81	\$84	314
206-301	\$150	\$187	\$217	\$224	314
206-302	\$150	\$187	\$217	\$224	314
233-402	\$336	\$420	\$487	\$504	309
233-405	\$336	\$420	\$487	\$504	309
233-407	\$336	\$420	\$487	\$504	309
233-408	\$336	\$420	\$487	\$504	309
233-601	\$383	\$479	\$555	\$574	310
233-603	\$383	\$479	\$555	\$574	310
233-604	\$383	\$479	\$555	\$574	310
233-606	\$383	\$479	\$555	\$574	310
233-607	\$383	\$479	\$555	\$574	310
243-401	\$336	\$420	\$487	\$504	308
243-403	\$336	\$420	\$487	\$504	308
243-404	\$336	\$420	\$487	\$504	308

PART	I	II	III	IV	PAGE
243-406	\$336	\$420	\$487	\$504	308
280A	\$710	\$887	\$1,029	\$1,065	320
280D	\$1,177	\$1,472	\$1,707	\$1,766	322
280E	\$1,580	\$1,975	\$2,348	\$2,370	322
280F	\$1,580	\$1,975	\$2,348	\$2,370	322
280G	\$1,031	\$1,288	\$1,494	\$1,546	320
280H	\$1,031	\$1,288	\$1,494	\$1,546	320
280J	\$1,031	\$1,288	\$1,494	\$1,546	320
280L	\$1,580	\$1,975	\$2,348	\$2,370	184
280M	\$1,031	\$1,288	\$1,494	\$1,546	320
280N	\$1,031	\$1,288	\$1,494	\$1,546	184
280P	\$708	\$885	\$1,026	\$1,062	261
280R	\$708	\$885	\$1,026	\$1,062	245
280S	\$1,262	\$1,577	\$1,917	\$1,917	323
280T	\$1,262	\$1,577	\$1,917	\$1,917	323
281-I	\$580	\$725	\$841	\$870	318
281A	\$682	\$852	\$1,013	\$1,022	320
281D	\$1,075	\$1,344	\$1,559	\$1,613	322
283-101	\$363	\$495	\$612	\$612	318
283-102	\$363	\$495	\$612	\$612	318
283-2	\$363	\$495	\$612	\$612	319
283-201	\$363	\$495	\$612	\$612	319
283-3	\$580	\$725	\$841	\$870	319
283-4	\$567	\$709	\$822	\$851	319
285-1	\$145	\$182	\$211	\$218	328
285-2	\$145	\$182	\$211	\$218	328
285-3	\$145	\$182	\$211	\$218	328
285-5	\$145	\$182	\$211	\$218	328
285-6	\$145	\$182	\$211	\$218	328
294-1	\$853	\$1,066	\$1,236	\$1,279	324
277-01	\$137				309
277-01-E	\$144				308
277-01A	\$86				308
277-02	\$207				310
277-02-E	\$179				310
277-02A	\$103				310
277-03	\$144				308
277-04	\$495	\$619	\$718	\$743	311
277-06	\$556	\$757	\$807	\$834	311
278-01	\$127				308
278-02	\$165				310
278A-01	\$104				308

PART	I	II	III	IV	PAGE
278A-02	\$138				310
278P-01	\$104				308
278P-02	\$138				310
295-I	\$875	\$1,093	\$1,268	\$1,312	325
296-I	\$192	\$240	\$279	\$288	329
2020-1200	\$235	\$294	\$341	\$353	209
2020-1230	\$276	\$345	\$400	\$414	209
2020-1250	\$324	\$405	\$470	\$486	209
2020-1500	\$308	\$385	\$446	\$462	209
2020-1570	\$263	\$329	\$381	\$395	209
2020-1650	\$120	\$150	\$174	\$180	209
2040-0442	\$1,228	\$1,535	\$1,793	\$1,842	327
2040-0443	\$1,228	\$1,535	\$1,793	\$1,842	327
2040-2400	\$271	\$338	\$392	\$406	358
2040-3942	\$847	\$1,059	\$1,229	\$1,271	359
2040-4261	\$2,862	\$3,578	\$4,150	\$4,293	261
2400-2400	\$318	\$430	\$482	\$482	358
2400-3942	\$847	\$1,059	\$1,229	\$1,271	360
2400-4272	\$2,081	\$2,602	\$3,082	\$3,122	131
2400-4273	\$2,081	\$2,602	\$3,082	\$3,122	131
2400-4282	\$2,081	\$2,602	\$3,018	\$3,122	132
2400-4283	\$2,081	\$2,602	\$3,018	\$3,122	132
2440-2400	\$318	\$430	\$482	\$482	358
2440-3942	\$847	\$1,059	\$1,229	\$1,271	360
2470-5103	\$1,569	\$1,962	\$2,276	\$2,354	47
2470-5183	\$1,826	\$2,283	\$2,648	\$2,739	47
2470-5203	\$1,264	\$1,580	\$1,833	\$1,896	48
2470-5223	\$1,500	\$1,875	\$2,175	\$2,250	48
2470-5233	\$1,235	\$1,544	\$1,791	\$1,853	48
2470-5303	\$1,269	\$1,587	\$1,841	\$1,904	47
2470-5313	\$1,634	\$2,043	\$2,370	\$2,451	47
2470-5432	\$1,787	\$2,234	\$2,592	\$2,681	48
2470-5433	\$1,787	\$2,234	\$2,592	\$2,681	47
2470-5462	\$1,878	\$2,348	\$2,724	\$2,817	47
2470-5463	\$1,878	\$2,348	\$2,724	\$2,817	47
2470-5503	\$1,485	\$1,857	\$2,154	\$2,228	48
2470-5603	\$1,118	\$1,398	\$1,622	\$1,677	48
2470-5613	\$849	\$1,062	\$1,232	\$1,274	48
2470-5623	\$681	\$852	\$988	\$1,022	49
2470-5711	\$258	\$323	\$375	\$387	49
2470-5721	\$398	\$498	\$578	\$597	49
2470-5811	\$382	\$478	\$554	\$573	30

PART	I	II	III	IV	PAGE
2470-7183	\$2,165	\$2,707	\$3,140	\$3,356	47
2480-2400	\$253	\$317	\$367	\$380	358
2480-3942	\$847	\$1,059	\$1,229	\$1,271	360
2480-4261	\$2,862	\$3,578	\$4,150	\$4,293	169
2500-5123	\$1,444	\$1,805	\$2,094	\$2,166	85
2500-5223	\$1,444	\$1,805	\$2,094	\$2,166	85
2500-5503	\$1,709	\$2,137	\$2,479	\$2,564	85
2500-5613	\$926	\$1,158	\$1,343	\$1,389	85
2500-5623	\$734	\$918	\$1,065	\$1,101	85
2500-5721	\$389	\$487	\$565	\$584	56
2510-5103	\$1,373	\$1,717	\$1,991	\$2,060	67
2510-5203	\$1,260	\$1,575	\$1,827	\$1,890	67
2540-1250	\$439	\$548	\$636	\$658	264
2540-1410	\$299	\$374	\$434	\$448	264
2540-1500	\$322	\$402	\$467	\$483	265
2540-1570	\$246	\$307	\$356	\$368	265
2540-1650	\$143	\$179	\$208	\$215	265
2540-1660	\$212	\$265	\$307	\$318	265
2560-4261	\$2,862	\$3,578	\$4,150	\$4,293	260
2560c	\$1,500	\$1,875	\$2,175	\$2,250	257
2570-2400	\$271	\$372	\$428	\$428	358
2570-3942	\$847	\$1,059	\$1,229	\$1,271	360
28500-15s	\$545				356
28500-26	\$433				356
28502-15s	\$847				356
28502-26	\$676				356
28505-15s	\$1,183				356
28505-26	\$946				356
2940-4261	\$2,862	\$3,578	\$4,150	\$4,293	270
2940-5103	\$1,444	\$1,805	\$2,094	\$2,166	81
2940-5123	\$1,636	\$2,045	\$2,373	\$2,454	81
2940-5173	\$1,636	\$2,045	\$2,373	\$2,454	81
2940-5223	\$1,444	\$1,805	\$2,094	\$2,166	82
2940-5233	\$1,055	\$1,509	\$1,759	\$1,759	81
2940-5413	\$2,950	\$3,688	\$4,278	\$4,425	81
2940-5463	\$1,878	\$2,348	\$2,724	\$2,817	81
2940-5503	\$1,591	\$1,989	\$2,307	\$2,387	82
2940-5603	\$1,156	\$1,445	\$1,677	\$1,734	82
2940-5613	\$883	\$1,104	\$1,281	\$1,325	82
2940-5623	\$735	\$919	\$1,066	\$1,103	82
2940-5711	\$194	\$243	\$282	\$291	82
2940-5721	\$389	\$487	\$565	\$584	82

PART	I	II	III	IV	PAGE
2940-5811	\$382	\$478	\$554	\$573	82
2940-7173	\$2,165	\$2,707	\$3,140	\$3,356	81
2940c	\$1,357	\$1,697	\$2,063	\$2,063	269
2940cs	\$1,357	\$1,697	\$1,968	\$2,036	269
2990c	\$1,500	\$1,875	\$2,175	\$2,250	257
34-01	\$363	\$454	\$527	\$545	136
34-02	\$387	\$484	\$562	\$581	136
34-09	\$242	\$313	\$355	\$370	136
34-12	\$198	\$247	\$287	\$296	136
34-13	\$234	\$292	\$339	\$350	137
34-27	\$238	\$298	\$345	\$357	137
34-28	\$342	\$427	\$495	\$512	137
35-01	\$363	\$454	\$527	\$545	136
35-02	\$387	\$484	\$562	\$581	136
35-09	\$264	\$330	\$383	\$396	136
35-12	\$198	\$247	\$287	\$296	136
35-13	\$234	\$292	\$339	\$350	137
35-27	\$238	\$298	\$345	\$357	137
35-28	\$342	\$427	\$495	\$512	137
36-01	\$272	\$340	\$394	\$408	248
36-02	\$333	\$416	\$483	\$499	248
36-09	\$392	\$490	\$568	\$587	248
36-12	\$107	\$134	\$155	\$161	248
36-13	\$199	\$248	\$288	\$298	248
36-27	\$273	\$341	\$396	\$409	248
36-28	\$316	\$394	\$457	\$473	249
37-02	\$365	\$456	\$544	\$547	264
37-09	\$327	\$409	\$475	\$491	264
37-12	\$139	\$174	\$201	\$208	265
37-28	\$334	\$417	\$484	\$501	265
38-02	\$362	\$453	\$528	\$543	185
38-09	\$261	\$326	\$378	\$391	185
38-12	\$316	\$394	\$457	\$473	186
38-27	\$490	\$612	\$710	\$735	186
38-28	\$370	\$463	\$537	\$555	186
4-1004BP	\$704	\$880	\$1,021	\$1,056	144
4-1034BP	\$704	\$880	\$1,021	\$1,056	144
4-1094BP	\$793	\$1,029	\$1,189	\$1,189	111
4-1204BP	\$704	\$880	\$1,021	\$1,056	217
3160-5103	\$1,619	\$2,024	\$2,348	\$2,429	87
3160-5203	\$1,619	\$2,024	\$2,348	\$2,429	87
3160-5503	\$1,619	\$2,024	\$2,348	\$2,429	87

PART	I	II	III	IV	PAGE
3160-5603	\$1,156	\$1,445	\$1,677	\$1,734	87
3160-5613	\$883	\$1,104	\$1,281	\$1,325	87
3160-5623	\$735	\$919	\$1,066	\$1,103	87
3160-5721	\$398	\$498	\$578	\$597	88
3160-5811	\$382	\$478	\$554	\$573	88
3170-5103	\$1,588	\$1,985	\$2,303	\$2,382	21
3170-5203	\$1,588	\$1,985	\$2,303	\$2,382	21
3170-5503	\$1,591	\$1,989	\$2,307	\$2,387	21
3170-5603	\$1,134	\$1,418	\$1,645	\$1,701	21
3170-5613	\$883	\$1,104	\$1,281	\$1,325	21
3170-5623	\$735	\$919	\$1,066	\$1,103	21
3170-5721	\$398	\$498	\$578	\$597	22
3170-5811	\$374	\$468	\$543	\$561	22
3180-5113	\$1,624	\$2,030	\$2,355	\$2,436	73
3180-5143	\$1,624	\$2,030	\$2,355	\$2,436	73
3180-5173	\$1,826	\$2,283	\$2,648	\$2,739	73
3180-5223	\$1,624	\$2,030	\$2,355	\$2,436	73
3180-5233	\$1,235	\$1,544	\$1,791	\$1,853	73
3180-5243	\$1,624	\$2,030	\$2,355	\$2,436	73
3180-5503	\$1,591	\$1,989	\$2,307	\$2,387	73
3180-5603	\$1,156	\$1,445	\$1,677	\$1,734	74
3180-5613	\$883	\$1,104	\$1,281	\$1,325	74
3180-5623	\$735	\$919	\$1,066	\$1,103	74
3180-5711	\$194	\$243	\$282	\$291	21
3180-5721	\$398	\$498	\$578	\$597	61
3190-5113	\$1,480	\$1,850	\$2,146	\$2,220	43
3190-5146	\$1,480	\$1,850	\$2,146	\$2,220	43
3190-5223	\$1,480	\$1,850	\$2,146	\$2,220	43
3190-5246	\$1,480	\$1,850	\$2,146	\$2,220	43
3190-5503	\$1,591	\$1,989	\$2,307	\$2,387	44
3190-5603	\$1,134	\$1,418	\$1,645	\$1,701	43
3190-5613	\$883	\$1,104	\$1,281	\$1,325	43
3190-5623	\$750	\$938	\$1,088	\$1,125	43
3190-5721	\$398	\$498	\$578	\$597	44
3190-5811	\$382	\$478	\$554	\$573	44
3200-5113	\$1,768	\$2,210	\$2,564	\$2,652	51
3200-5223	\$1,768	\$2,210	\$2,564	\$2,652	51
3200-5503	\$1,591	\$1,989	\$2,307	\$2,387	51
3200-5603	\$1,156	\$1,445	\$1,677	\$1,734	51
3200-5613	\$883	\$1,104	\$1,281	\$1,325	51
3200-5623	\$735	\$919	\$1,066	\$1,103	51
3200-5721	\$398	\$498	\$578	\$597	52

PART	I	II	III	IV	PAGE
3200-5811	\$374	\$468	\$543	\$561	52
3210-5103	\$1,516	\$1,895	\$2,199	\$2,274	39
3210-5203	\$1,516	\$1,895	\$2,199	\$2,274	39
3210-5503	\$1,591	\$1,989	\$2,307	\$2,387	39
3210-5603	\$1,156	\$1,445	\$1,677	\$1,734	39
3210-5613	\$883	\$1,104	\$1,281	\$1,325	39
3210-5623	\$750	\$938	\$1,088	\$1,125	39
3210-5721	\$398	\$498	\$578	\$597	40
3210-5811	\$382	\$478	\$554	\$573	40
3230-1230	\$379	\$473	\$549	\$568	238
3230-1250	\$421	\$526	\$611	\$632	238
3230-1410	\$289	\$362	\$419	\$434	238
3230-1510	\$286	\$357	\$415	\$429	238
3230-1530	\$393	\$491	\$569	\$589	239
3230-1650	\$236	\$295	\$365	\$365	238
3230-1660	\$268	\$334	\$393	\$401	238
3230-5143	\$1,624	\$2,030	\$2,355	\$2,436	69
3230-5233	\$1,055	\$1,319	\$1,530	\$1,583	69
3230-5243	\$1,624	\$2,030	\$2,355	\$2,436	69
3230-5413	\$2,950	\$3,688	\$4,278	\$4,425	69
3230-5463	\$2,083	\$2,604	\$3,021	\$3,125	69
3230-5503	\$1,591	\$1,989	\$2,307	\$2,387	70
3230-5603	\$1,156	\$1,445	\$1,677	\$1,734	69
3230-5613	\$883	\$1,104	\$1,281	\$1,325	70
3230-5623	\$735	\$919	\$1,066	\$1,103	70
3230-7173	\$1,988	\$2,485	\$2,883	\$2,982	69
3230c	\$1,500	\$1,875	\$2,175	\$2,250	235
3240c	\$1,500	\$1,875	\$2,175	\$2,250	235
3250-1230	\$379	\$473	\$549	\$568	154
3250-1250	\$421	\$526	\$611	\$632	154
3250-1410	\$289	\$362	\$419	\$434	153
3250-1510	\$286	\$357	\$415	\$429	154
3250-1530	\$393	\$491	\$569	\$589	154
3250-1650	\$236	\$295	\$365	\$365	154
3250-1660	\$268	\$334	\$393	\$401	154
3250c	\$1,500	\$1,875	\$2,175	\$2,250	151
3260c	\$1,500	\$1,875	\$2,175	\$2,250	151
3270-1230	\$379	\$473	\$549	\$568	181
3270-1250	\$421	\$526	\$611	\$632	181
3270-1410	\$289	\$362	\$419	\$434	180
3270-1510	\$286	\$357	\$415	\$429	181
3270-1530	\$393	\$491	\$569	\$589	181

PART	I	II	III	IV	PAGE
3270-1650	\$236	\$295	\$365	\$365	181
3270-1660	\$268	\$334	\$393	\$401	181
3270c	\$1,500	\$1,875	\$2,175	\$2,250	177
3280c	\$1,500	\$1,875	\$2,175	\$2,250	177
3290-1230	\$380	\$475	\$551	\$570	205
3290-1250	\$421	\$526	\$611	\$632	205
3290-1400	\$409	\$511	\$593	\$614	205
3290-1500	\$334	\$417	\$484	\$501	205
3290-1570	\$283	\$353	\$410	\$424	205
3290-1650	\$157	\$197	\$228	\$236	205
3290-1660	\$208	\$259	\$301	\$311	205
3290-4261	\$2,862	\$3,578	\$4,150	\$4,293	230
3290-5113	\$1,783	\$2,229	\$2,586	\$2,675	59
3290-5143	\$1,783	\$2,229	\$2,586	\$2,675	59
3290-5173	\$2,016	\$2,520	\$2,924	\$3,024	59
3290-5223	\$1,745	\$2,182	\$2,531	\$2,618	60
3290-5233	\$1,415	\$1,769	\$2,052	\$2,123	60
3290-5413	\$2,950	\$3,688	\$4,278	\$4,425	59
3290-5463	\$2,083	\$2,604	\$3,021	\$3,125	59
3290-5503	\$1,591	\$1,989	\$2,307	\$2,387	60
3290-5603	\$1,156	\$1,445	\$1,677	\$1,734	60
3290-5613	\$883	\$1,104	\$1,281	\$1,325	60
3290-5623	\$735	\$919	\$1,066	\$1,103	60
3290-5811	\$382	\$478	\$554	\$573	61
3290-7173	\$2,165	\$2,707	\$3,140	\$3,356	59
3310-5103	\$1,516	\$1,895	\$2,199	\$2,274	77
3310-5203	\$1,516	\$1,895	\$2,199	\$2,274	77
3310-5503	\$1,591	\$1,989	\$2,307	\$2,387	77
3310-5603	\$1,156	\$1,445	\$1,677	\$1,734	77
3310-5613	\$883	\$1,104	\$1,281	\$1,325	77
3310-5623	\$735	\$919	\$1,066	\$1,103	77
3310-5721	\$398	\$498	\$578	\$597	78
3320c	\$1,357	\$1,697	\$2,000	\$2,036	273
3330c	\$1,357	\$1,697	\$2,000	\$2,036	273
3360-5113	\$1,783	\$2,229	\$2,586	\$2,675	59
3360-5413	\$2,950	\$3,688	\$4,278	\$4,425	60
3420-4263	\$3,881	\$4,851	\$5,627	\$6,015	203
3420-4273	\$3,081	\$3,851	\$4,467	\$4,776	202
3420-4283	\$2,781	\$3,476	\$4,032	\$4,311	203
3420c	\$1,850	\$2,313	\$2,683	\$2,868	201
3430-4262	\$3,881	\$4,851	\$5,627	\$6,015	203
3430-4272	\$3,081	\$3,851	\$4,467	\$4,776	202

PART	I	II	III	IV	PAGE
3430-4282	\$2,781	\$3,476	\$4,032	\$4,311	203
3430C	\$1,850	\$2,313	\$2,683	\$2,868	201
4-1224BP	\$704	\$880	\$1,021	\$1,056	217
4-1234BP	\$748	\$973	\$1,125	\$1,125	217
4-1504BP	\$704	\$880	\$1,021	\$1,056	170
4-1604BP	\$704	\$880	\$1,021	\$1,056	225
4-1624BP	\$704	\$880	\$1,021	\$1,056	225
4-1744BP	\$704	\$917	\$1,045	\$1,056	252
4-1764BP	\$704	\$880	\$1,021	\$1,056	285
4-1774BP	\$704	\$880	\$1,021	\$1,056	285
4-2044BP	\$780	\$975	\$1,131	\$1,170	261
4-2064BP	\$780	\$975	\$1,131	\$1,170	262
4-2404BP	\$780	\$975	\$1,131	\$1,171	133
4-2414BP	\$780	\$975	\$1,131	\$1,171	133
4-2444BP	\$780	\$975	\$1,131	\$1,171	133
4-2454BP	\$780	\$975	\$1,131	\$1,171	133
4-2494BP	\$780	\$975	\$1,131	\$1,171	246
4-2544BP	\$780	\$1,016	\$1,171	\$1,171	261
4-2554BP	\$780	\$1,016	\$1,171	\$1,171	184
4-2574BP	\$780	\$986	\$1,137	\$1,171	197
4-2914BP	\$780	\$975	\$1,131	\$1,171	279
4-2924BP	\$704	\$880	\$1,021	\$1,056	170
4-2944BP	\$704	\$880	\$1,021	\$1,056	270
4-2974BP	\$829	\$1,080	\$1,245	\$1,245	158
4-2984BP	\$829	\$1,080	\$1,245	\$1,245	158
4-3104BP	\$829	\$1,037	\$1,203	\$1,244	246
4-3144BP	\$737	\$957	\$1,105	\$1,105	207
4-3154BP	\$737	\$957	\$1,105	\$1,105	208
4-3234BP	\$744	\$1,039	\$1,187	\$1,187	237
4-3244BP	\$744	\$1,039	\$1,187	\$1,187	237
4-3254BP	\$744	\$1,039	\$1,187	\$1,187	152
4-3264BP	\$744	\$1,039	\$1,187	\$1,187	152
4-3274BP	\$744	\$1,039	\$1,187	\$1,187	179
4-3284BP	\$744	\$1,039	\$1,187	\$1,187	179
4-3294BP	\$744	\$1,039	\$1,187	\$1,187	231
4-3304BP	\$744	\$1,039	\$1,187	\$1,247	231
4-3324BP	\$780	\$975	\$1,131	\$1,170	275
4-3334BP	\$780	\$975	\$1,131	\$1,170	275
4-3424BP	\$929	\$1,161	\$1,347	\$1,440	204
4-3434BP	\$929	\$1,161	\$1,347	\$1,440	204
4-854BP	\$704	\$880	\$1,021	\$1,056	252
4-914BP	\$704	\$880	\$1,021	\$1,056	123

PART	I	II	III	IV	PAGE
4-924BP	\$704	\$880	\$1,021	\$1,056	123
4-984BP	\$704	\$880	\$1,021	\$1,056	115
4-994BP	\$704	\$880	\$1,021	\$1,056	170
4-994LBP	\$481	\$601	\$698	\$722	170
40-02	\$318	\$397	\$464	\$476	280
40-10	\$260	\$325	\$377	\$390	280
40-13	\$297	\$371	\$430	\$445	280
40-28	\$297	\$371	\$431	\$445	280
403-1	\$272	\$369	\$421	\$442	374
403-3	\$332	\$407	\$452	\$475	374
403X	\$161	\$215	\$237	\$249	374
403X-1	\$340	\$401	\$452	\$475	374
404X	\$143	\$188	\$215	\$226	373
41-02	\$355	\$443	\$514	\$532	198
41-09	\$295	\$368	\$428	\$442	198
41-12	\$165	\$207	\$240	\$248	198
41-27	\$276	\$345	\$400	\$414	199
41-28	\$334	\$417	\$484	\$501	199
416X	\$211	\$285	\$319	\$335	374
417X	\$226	\$307	\$351	\$369	375
42-01	\$411	\$514	\$596	\$617	160
42-02	\$434	\$543	\$630	\$651	160
42-09	\$297	\$371	\$430	\$445	160
42-12	\$172	\$214	\$249	\$257	160
42-13	\$211	\$263	\$306	\$316	160
42-27	\$300	\$375	\$435	\$450	160
42-28	\$354	\$442	\$513	\$530	160
482-1	\$339	\$464	\$535	\$562	376
482X	\$226	\$307	\$344	\$361	375
482X-1	\$361	\$487	\$555	\$583	376
493-1	\$641	\$884	\$1,016	\$1,067	376
493X	\$407	\$570	\$661	\$694	376
493X-1	\$672	\$903	\$1,050	\$1,103	377
495X	\$211	\$307	\$357	\$375	376
499-1	\$157	\$226	\$240	\$252	372
499-2	\$276	\$372	\$424	\$445	372
499-3	\$276	\$372	\$424	\$445	372
5-036	\$787				102
5-1002BP	\$794	\$993	\$1,152	\$1,191	145
5-1032BP	\$794	\$993	\$1,152	\$1,191	144
5-1092BP	\$894	\$1,162	\$1,340	\$1,341	111
5-1202BP	\$794	\$993	\$1,152	\$1,191	217

PART	I	II	III	IV	PAGE
5-1222BP	\$794	\$993	\$1,152	\$1,191	218
5-1232BP	\$894	\$1,118	\$1,297	\$1,341	217
5-1602BP	\$794	\$993	\$1,152	\$1,191	225
5-1622BP	\$794	\$993	\$1,152	\$1,191	225
5-1742BP	\$806	\$1,048	\$1,207	\$1,207	252
5-1762BP	\$794	\$993	\$1,152	\$1,191	286
5-1772BP	\$794	\$993	\$1,152	\$1,191	285
5-2042BP	\$889	\$1,112	\$1,290	\$1,334	262
5-2062BP	\$889	\$1,112	\$1,290	\$1,334	262
5-2402BP	\$889	\$1,112	\$1,290	\$1,334	134
5-2412BP	\$889	\$1,112	\$1,290	\$1,334	133
5-2442BP	\$889	\$1,112	\$1,290	\$1,334	134
5-2452BP	\$889	\$1,112	\$1,290	\$1,334	133
5-2492BP	\$889	\$1,112	\$1,290	\$1,334	246
5-2542BP	\$879	\$1,144	\$1,321	\$1,321	262
5-2552BP	\$879	\$1,144	\$1,321	\$1,321	184
5-2572BP	\$879	\$1,113	\$1,280	\$1,319	197
5-2912BP	\$879	\$1,099	\$1,275	\$1,319	279
5-2922BP	\$794	\$993	\$1,152	\$1,191	171
5-2942BP	\$794	\$993	\$1,152	\$1,191	270
5-2972BP	\$889	\$1,113	\$1,290	\$1,334	158
5-2982BP	\$889	\$1,113	\$1,290	\$1,334	158
5-3102BP	\$829	\$1,037	\$1,203	\$1,244	246
5-3142BP	\$829	\$1,080	\$1,245	\$1,245	208
5-3152BP	\$829	\$1,080	\$1,245	\$1,245	208
5-3232BP	\$894	\$1,171	\$1,314	\$1,341	237
5-3242BP	\$894	\$1,171	\$1,314	\$1,341	237
5-3252BP	\$894	\$1,171	\$1,314	\$1,341	152
5-3262BP	\$894	\$1,171	\$1,314	\$1,341	152
5-3272BP	\$894	\$1,171	\$1,314	\$1,341	179
5-3282BP	\$894	\$1,171	\$1,314	\$1,341	179
5-3292BP	\$894	\$1,171	\$1,314	\$1,341	231
5-3302BP	\$894	\$1,171	\$1,314	\$1,341	231
5-3422BP	\$1029	\$1286	\$1492	\$1595	204
5-3432BP	\$1029	\$1286	\$1492	\$1595	204
5-3322BP	\$889	\$1,112	\$1,290	\$1,334	275
5-3332BP	\$889	\$1,112	\$1,290	\$1,334	275
5-852BP	\$794	\$993	\$1,152	\$1,191	252
5-912BP	\$794	\$993	\$1,152	\$1,191	123
5-922BP	\$794	\$993	\$1,152	\$1,191	123
5-982BP	\$794	\$993	\$1,152	\$1,191	116
5-992BP	\$794	\$993	\$1,152	\$1,191	171

PART	I	II	III	IV	PAGE
5-992LBP	\$592	\$740	\$859	\$888	171
501-15	\$282				354
501-15s	\$284				354
501-26	\$206				354
503L-15	\$476				354
503L-15s	\$284				354
503L-26	\$370				354
504L-15	\$485				354
504L-15s	\$485				354
504L-26	\$401				354
505L-15	\$485				354
505L-15s	\$485				354
505L-26	\$401				354
5080sq	\$223	\$278	\$323	\$334	359
5081sq	\$272	\$340	\$394	\$408	359
5082sq	\$299	\$374	\$434	\$448	359
5083sq	\$347	\$434	\$503	\$520	359
5085sq	\$454	\$567	\$658	\$681	359
516-10	\$171	\$213	\$252	\$256	316
516-12	\$241	\$302	\$356	\$362	316
516-18	\$241	\$302	\$356	\$362	316
516-2	\$171	\$213	\$252	\$256	316
516-24	\$297	\$371	\$446	\$446	316
516-30	\$297	\$371	\$446	\$446	316
516-36	\$374	\$468	\$553	\$561	316
516-4	\$171	\$213	\$252	\$256	316
516-42	\$374	\$468	\$553	\$561	316
516-6	\$171	\$213	\$252	\$256	316
516-8	\$171	\$213	\$252	\$256	316
517-10	\$155	\$194	\$226	\$233	316
517-12	\$208	\$260	\$308	\$311	316
517-18	\$212	\$265	\$308	\$318	316
517-2	\$155	\$194	\$226	\$233	316
517-24	\$256	\$319	\$376	\$383	316
517-30	\$256	\$319	\$376	\$383	316
517-36	\$314	\$393	\$469	\$471	316
517-4	\$155	\$194	\$226	\$233	316
517-42	\$314	\$393	\$469	\$471	316
517-6	\$155	\$194	\$226	\$233	316
517-8	\$155	\$194	\$226	\$233	316
550G-15	\$111				355
550G-15s	\$111				355

PART	I	II	III	IV	PAGE
550G-26	\$91				355
550G-56	\$111				355
552G-15	\$274				355
552G-15s	\$274				355
552G-26	\$228				355
552G-56	\$274				355
553DG-15	\$143				355
553DG-26	\$122				355
553DG-56	\$143				355
553DG15s	\$143				355
553G-15	\$137				355
553G-15s	\$137				355
553G-26	\$119				355
553G-56	\$137				355
554DG-15	\$253				356
554DG-15s	\$253				356
554DG-26	\$202				356
554DG-56	\$253				356
599-15	\$74				355
599-15s	\$74				355
599-26	\$51				355
6-027	\$246	\$308	\$357	\$369	37
6-028	\$235	\$294	\$341	\$353	21
6-505	\$139	\$174	\$201	\$208	137
8-030	\$474	\$592	\$686	\$710	261
850c	\$1,357	\$1,697	\$1,968	\$2,036	251
890-1230	\$264	\$330	\$383	\$396	126
890-1250	\$309	\$387	\$449	\$464	126
890-1400	\$246	\$307	\$356	\$368	125
890-1410	\$197	\$246	\$285	\$295	125
890-1500	\$289	\$362	\$420	\$434	126
890-1510	\$246	\$307	\$356	\$368	126
890-1650	\$87	\$108	\$125	\$130	126
890-1660	\$176	\$220	\$255	\$264	126
910-4261	\$2,862	\$3,578	\$4,150	\$4,293	122
910-4273	\$2,171	\$2,713	\$3,147	\$3,256	121
910-4283	\$2,071	\$2,589	\$3,003	\$3,107	122
910c	\$1,198	\$1,498	\$1,738	\$1,797	119
920-2400	\$197	\$246	\$309	\$309	358
920-3942	\$734	\$917	\$1,064	\$1,101	359
920-4272	\$2,171	\$2,713	\$3,147	\$3,256	121
920-4282	\$2,071	\$2,589	\$3,003	\$3,107	122

PART	I	II	III	IV	PAGE
920c	\$1,198	\$1,498	\$1,738	\$1,797	119
930-0442	\$1,228	\$1,535	\$1,793	\$1,842	326
930-0443	\$1,228	\$1,535	\$1,793	\$1,842	326
930-4261	\$2,862	\$3,578	\$4,150	\$4,293	144
930B	\$1,786	\$2,233	\$2,590	\$2,679	139
930L	\$1,357	\$1,697	\$1,968	\$2,036	139
945-1	\$2,041	\$2,552	\$2,960	\$3,062	28
990-0442	\$1,228	\$1,535	\$1,793	\$1,842	326
990-0443	\$1,228	\$1,535	\$1,793	\$1,842	326
990-1200	\$233	\$292	\$338	\$350	174
990-1230	\$275	\$344	\$399	\$413	174
990-1250	\$295	\$369	\$428	\$443	174
990-1500	\$275	\$344	\$399	\$449	174
990-1570	\$169	\$212	\$246	\$254	174
990-1650	\$101	\$127	\$147	\$152	174
990-1660	\$133	\$167	\$193	\$200	174
990-2400	\$197	\$246	\$309	\$309	358
990-3942	\$734	\$917	\$1,064	\$1,101	359
990IL	\$1,581	\$1,977	\$2,293	\$2,372	34
990L	\$1,357	\$1,697	\$1,968	\$2,036	163
990LS	\$1,357	\$1,697	\$1,968	\$2,036	163
990S	\$1,357	\$1,697	\$1,968	\$2,036	163
991IL	\$1,913	\$2,392	\$2,815	\$2,870	34
999L	\$1,925	\$2,477	\$2,973	\$2,973	174
9481	\$1334	\$1668	\$1944	\$2001	30
9485	\$1334	\$1668	\$1944	\$2001	37
98000	\$39				4
G502-15	\$284				354
G502-15s	\$284				354
G502-26	\$208				354
G504-15	\$476				354
G504-15s	\$284				354
G504-26	\$370				354
RPI-288	\$50				308
RP20-407	\$156	\$195	\$227	\$234	363



NEWPORT BRASS

PRICEBOOK (part#PB0326)
EFFECTIVE 3/8/26

2001 Carnegie Ave
Santa Ana, CA 92705

T: 949.417.5207 F: 949.417.5208